

REVISIONS					
REV	ECO	DESCRIPTION	DATE	BY	APPR
A1	-	RELEASE NUMBER	30/NOV/18	BROOK	TOMMY

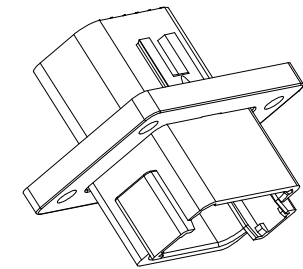
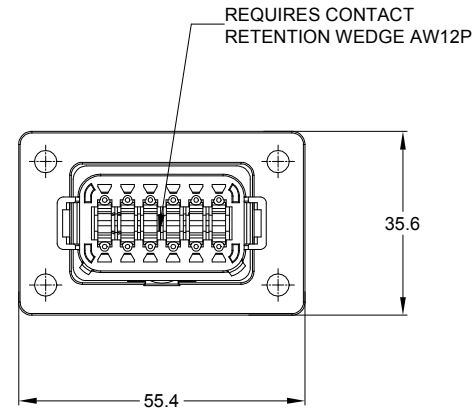
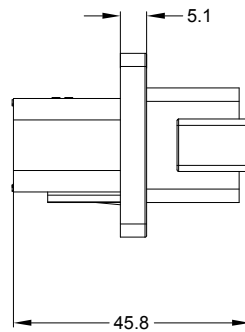
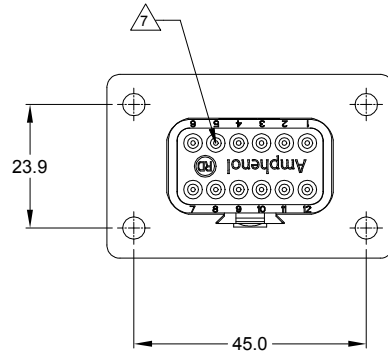
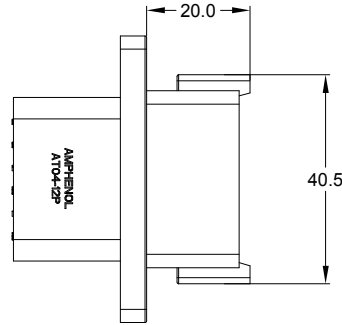

NOTES: UNLESS OTHERWISE SPECIFIED

1. SEE SHEET 2 FOR KEY ARRANGEMENTS AND COLORS.

2. MATERIAL:
HOUSING: THERMOPLASTIC
SEAL: SILICONE RUBBER

3. MODIFICATIONS: FLANGE, REDUCED DIA. WIRE SEAL

4. SPECIFICATIONS:
4.1 CURRENT RATING: 13 AMPS
4.2 OPERATING TEMPERATURE: -55°C TO +125°C.
4.3 DIELECTRIC WITHSTANDING VOLTAGE: LESS THAN 2 MILLIAMPS CURRENT LEAKAGE @ 1500 VOLTS AC.
4.4 INSULATION RESISTANCE: 1000 MEGOHMS MIN @ 25°C.
4.5 MOISTURE RESISTANCE: IP67 (MATED CONDITION)
4.6 MATING CYCLE DURABILITY: 100 CYCLES
4.7 RoHS COMPLIANT

5. MATING PART: AT06-12SX* PLUG.
(X=A,B,C,D KEYS, * = MODIFICATIONS AND COLORS)

6. ALL DIMENSIONS ARE FOR REFERENCE USE ONLY.

7. CONTACT SIZE AND REAR SEAL WIRE RANGE:

CONTACT SIZE	MIN. INSUL O.D.	MAX. INSUL O.D.	TYPICAL WIRE RANGE
16	1.35 mm (.053 in)	3.05 mm (.120 in)	16 - 20 AWG

SEE SHEET 2		DESCRIPTION		ITEM
PART NUMBER				
QUANTITY	MATERIALS LIST			
UNLESS OTHERWISE SPECIFIED: 1) All dimensions are in metric (mm). 2) Tolerances are as follows: 1 PL DEC ±0.30 Fractions ±1/64 2 PL DEC ±0.15 Angles ±1° 3 PL DEC ±0.08		SIGNATURES		DATE
DRAWN: BROOK		30/NOV/18		
CHECKED: ORION		30/NOV/18		
APPROVAL: TOMMY		30/NOV/18		
MATERIAL SPECIFICATIONS:		CUSTOMER:		
PROCESS SPECIFICATIONS:		THIS DRAWING IS SUPPLIED FOR INFORMATION ONLY. DESIGN FEATURES, SPECIFICATIONS AND PERFORMANCE DATA SHOWN HEREON ARE THE PROPERTY OF THE AMPHENOL CORPORATION. NO RIGHTS OF REPRODUCTION ARE IMPLIED. ALL DIMENSIONS ARE SUBJECT TO NORMAL MANUFACTURING VARIATIONS.		
NEXT ASSY:		SCALE: NONE		
		SIZE: B C-		REVISION: A1
		DWG NO: AT04-12PX-CL03		
		SHEET 1 OF 3		

TITLE: 12P RECEPTACLE, FLANGE MOUNT, RD
DWG NO: AT04-12PX-CL03
REV: A1
SH: 1
OF: 3

REVISIONS					
REV	ECO	DESCRIPTION	DATE	BY	APPR
A1	-	RELEASE NUMBER	30/NOV/18	BROOK	TOMMY

KEY A CONFIGURATION
STANDARD COLOR:GREY

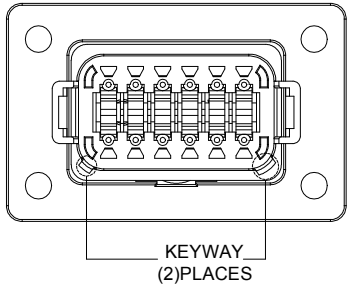
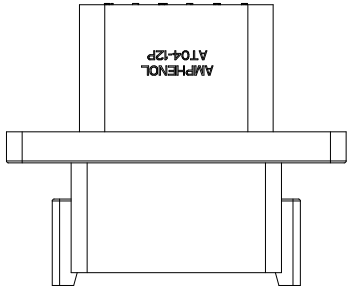

KEY-A CONFIGURATION	
COLOR	PART NUMBER
GREY	AT04-12PA-CL03

KEY B CONFIGURATION
STANDARD COLOR:BLACK

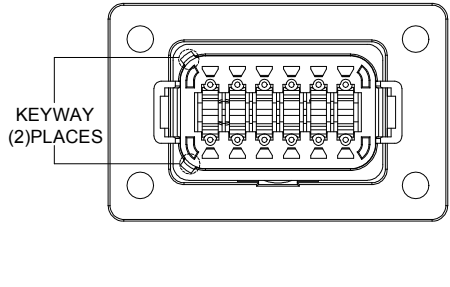
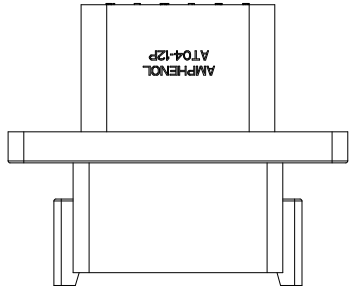

KEY-B CONFIGURATION	
COLOR	PART NUMBER
BLACK	AT04-12PB-CL03

KEY C CONFIGURATION
STANDARD COLOR:GREEN

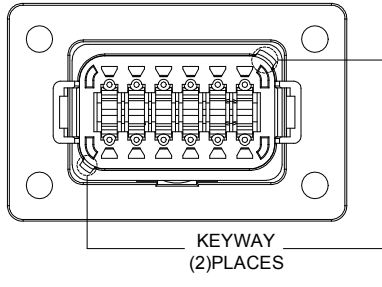
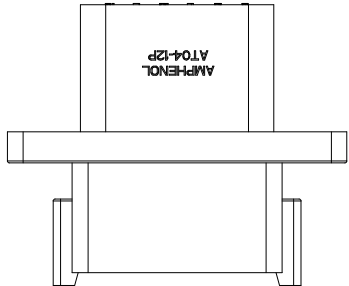

KEY-C CONFIGURATION	
COLOR	PART NUMBER
GREEN	AT04-12PC-CL03

KEY D CONFIGURATION
STANDARD COLOR:BROWN

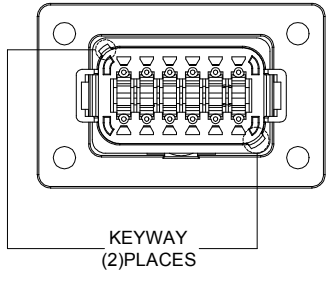
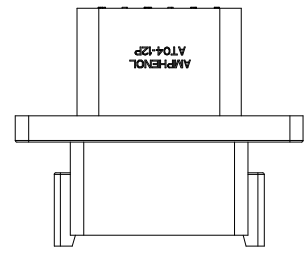

KEY-D CONFIGURATION	
COLOR	PART NUMBER
BROWN	AT04-12PD-CL03

TITLE: 12P RECEPTACLE, FLANGE MOUNT, RD
DWG NO.: AT04-12PX-CL03
REV: A1
SH: 2
OF: 3

SEE SHEET 2		DESCRIPTION		ITEM
PART NUMBER		DESCRIPTION		
QUANTITY	MATERIALS LIST			
UNLESS OTHERWISE SPECIFIED 1) All dimensions are in metric(mm). 2) Tolerances are as follows: 1 PL DEC ±0.30 Fractions ±1/64 2 PL DEC ±0.15 Angles ±1° 3 PL DEC ±0.08 3) Note reference =	SIGNATURES	DATE	 Sine Systems - www.amphenol-sine.com 44724 Morley Drive Clinton Township, MI 48036 12P RECEPTACLE, FLANGE MOUNT, RD	
	DRAWN: BROOK	30/NOV/18		
	CHECKED: ORION	30/NOV/18		
	APPROVAL: TOMMY	30/NOV/18		
MATERIAL SPECIFICATIONS:	CUSTOMER:		THIS DRAWING IS SUPPLIED FOR INFORMATION ONLY. DESIGN FEATURES, SPECIFICATIONS AND PERFORMANCE DATA SHOWN HEREON ARE THE PROPERTY OF THE AMPHENOL CORPORATION. NO RIGHTS OF REPRODUCTION ARE IMPLIED. ALL DIMENSIONS ARE SUBJECT TO NORMAL MANUFACTURING VARIATIONS.	
PROCESS SPECIFICATIONS:	SCALE: NONE		SIZE: B C-	DWG NO.: AT04-12PX-CL03
NEXT ASSY:	SHEET 2 OF 3		REVISION: A1	

REVISIONS					
REV	ECO	DESCRIPTION	DATE	BY	APPR
A1	-	RELEASE NUMBER	30/NOV/18	BROOK	TOMMY

FOR REFERENCE ONLY

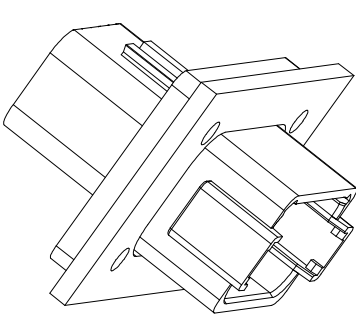

FRONT MOUNT

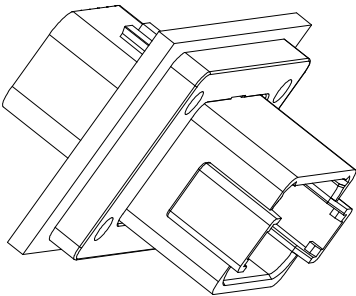

REAR MOUNT

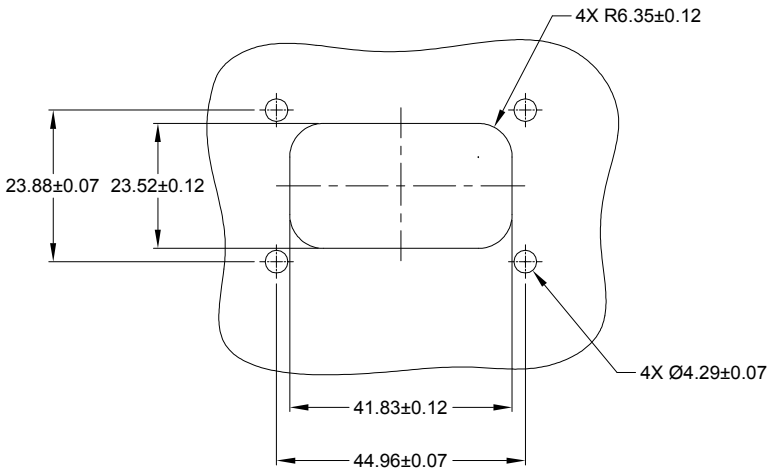



RECOMMENDED CUTOUT
FRONT AND REAR MOUNT



TITLE: 12P RECEPTACLE, FLANGE MOUNT, RD
DWG NO.: AT04-12PX-CL03
REV/A1
SH: 3
OF: 3

SEE SHEET 2		DESCRIPTION		ITEM
PART NUMBER				
QUANTITY		MATERIALS LIST		
<p>UNLESS OTHERWISE SPECIFIED</p> <p>1) All dimensions are in metric (mm).</p> <p>2) Tolerances are as follows:</p> <p>1 PL DEC ±0.30 2 PL DEC ±0.15 3 PL DEC ±0.08</p> <p>Fractions ±1/64 Angles ±1°</p> <p>3) Note reference = </p>		<p>SIGNATURES</p> <p>DRAWN: BROOK CHECKED: ORION ENGINEER: APPROVAL: TOMMY</p> <p>DATE</p> <p>30/NOV/18 30/NOV/18 30/NOV/18</p>	<p>Amphenol</p> <p>Sine Systems - www.amphenol-sine.com 44724 Morley Drive Clinton Township, MI 48036</p>	
MATERIAL SPECIFICATIONS:		CUSTOMER:		
PROCESS SPECIFICATIONS:		<p>THIS DRAWING IS SUPPLIED FOR INFORMATION ONLY. DESIGN FEATURES, SPECIFICATIONS AND PERFORMANCE DATA SHOWN HEREON ARE THE PROPERTY OF THE AMPHENOL CORPORATION. NO RIGHTS OF REPRODUCTION ARE IMPLIED. ALL DIMENSIONS ARE SUBJECT TO NORMAL MANUFACTURING VARIATIONS.</p>		
NEXT ASSY:		<p>SIZE: B C-</p> <p>SCALE: NONE</p>	<p>DWG NO.: AT04-12PX-CL03</p>	<p>REVISION: A1</p> <p>SHEET 3 OF 3</p>



AT Series™ - Contact Size 16 Options

Machined Contacts, Sockets & Pins				
Part Number	Description	Size	AWG	Type
AT60-215-1631	Male Contact - Pin, Gold-plated	16	14	Machined
AT62-209-1631	Female Contact - Socket, Gold-plated	16	14	Machined
AT60-215-16141	Male Contact - Pin, Nickel-plated	16	14	Machined
AT62-209-16141	Female Contact - Socket, Nickel-plated	16	14	Machined
AT60-202-1631	Male Contact - Pin, Gold-plated	16	16-20	Machined
AT62-201-1631	Female Contact - Socket, Gold-plated	16	16-20	Machined
AT60-202-16141	Male Contact - Pin, Nickel-plated	16	16-20	Machined
AT62-201-16141	Female Contact - Socket, Nickel-plated	16	16-20	Machined
AT60-202-1631-22	Male Contact - Pin, Gold-plated	16	22-24	Machined
AT62-201-1631-22	Female Contact - Socket, Gold-plated	16	22-24	Machined
AT60-202-16141-22	Male Contact - Pin, Nickel-plated	16	22-24	Machined
AT62-201-16141-22	Female Contact - Socket, Nickel-plated	16	22-24	Machined

Tooling - Machined Contacts		
Part	Part Number	Description
	CA-5D12	Universal Hand Crimp Tool, Size 12/16/20 (Machined contacts only)
	CA-5E12	Pneumatic Crimp Tool, Size 12/16/20 (Machined contacts only)

Contact Removal Tools		
Part	Part Number	Description
	ATRT-100	Used for removal of contacts for A Series™ products
	AT11-310-1605	Contact Removal Tool, Plastic, Size 16
	A114017	Sealing Plug, Size 16, White

Stamped & Formed Contacts, Sockets & Pins				
Part Number	Description	Size	AWG	Type
AT60-14-0144	Male Contact - Pin, Gold-plated	16	14-16	Stamped & Formed
AT62-14-0144	Female Contact - Socket, Gold-plated	16	14-16	Stamped & Formed
AT60-14-0122	Male Contact - Pin, Nickel-plated	16	14-16	Stamped & Formed
AT62-14-0122	Female Contact - Socket, Nickel-plated	16	14-16	Stamped & Formed
AT60-16-0144	Male Contact - Pin, Gold-plated	16	16-18	Stamped & Formed
AT62-16-0144	Female Contact - Socket, Gold-plated	16	16-18	Stamped & Formed
AT60-16-0122	Male Contact - Pin, Nickel-plated	16	16-18	Stamped & Formed
AT62-16-0122	Female Contact - Socket, Nickel-plated	16	16-18	Stamped & Formed
AT60-16-0644	Male Contact - Pin, Gold-plated	16	18-20	Stamped & Formed
AT62-16-0644	Female Contact - Socket, Gold-plated	16	18-20	Stamped & Formed
AT60-16-0622	Male Contact - Pin, Nickel-plated	16	18-20	Stamped & Formed
AT62-16-0622	Female Contact - Socket, Nickel-plated	16	18-20	Stamped & Formed
AT60-16-0844	Male Contact - Pin, Gold-plated	16	20-22	Stamped & Formed
AT62-16-0844	Female Contact - Socket, Gold-plated	16	20-22	Stamped & Formed
AT60-16-0822	Male Contact - Pin, Nickel-plated	16	20-22	Stamped & Formed
AT62-16-0822	Female Contact - Socket, Nickel-plated	16	20-22	Stamped & Formed

Tooling - Stamped & Formed Contacts		
Part	Part Number	Description
	MFY-3950	Crimp Die - Size 16, 18-20AWG (S&F contacts only)
	MFY-3953	Crimp Die - Size 16, 16-18AWG (S&F contacts only)
	MFY-3975	Crimp Die - Size 16, 14-16AWG (S&F contacts only)
	MFY-3990	Crimp Die - Size 16, 20-22AWG (S&F contacts only)
	ATT-16-00	Hand Crimp Tool - Size 16, 14-16AWG (S&F contacts only)
	ATT-16-01	Hand Crimp Tool - Size 16, 18-20AWG (S&F contacts only)
	ATT-1612-03	Hand Crimp Tool - Size 16, 20-22AWG (S&F contacts only)

Amphenol Sine Systems
 44724 Morley Drive
 Clinton Township, MI 48036 USA
www.amphenol-sine.com
 09/2021