

DF-G2 High Speed Expert™ Dual Display Fiber Amplifier

Instruction Manual

Original Instructions
177899 Rev. F
9 September 2021
© Banner Engineering Corp. All rights reserved



177899

Contents

| | |
|--|-----------|
| 1 Product Description | 3 |
| 1.1 Models | 3 |
| 1.2 Overview | 4 |
| 1.3 Top Panel Interface | 4 |
| 2 Installation Instructions | 6 |
| 2.1 Mounting Instructions | 6 |
| 2.2 Installing the Fibers in a DF-Gx Sensor | 6 |
| 2.3 Fiber Adapters | 7 |
| 2.4 Wiring Diagrams | 7 |
| 3 Operating Instructions | 8 |
| 3.1 Run Mode | 8 |
| 3.2 Program Mode | 8 |
| 3.2.1 TEACH Selection | 9 |
| 3.2.2 Response Speed | 10 |
| 3.2.3 Offset Percent | 10 |
| 3.2.4 Auto Thresholds | 10 |
| 3.2.5 Delays/Timers | 11 |
| 3.2.6 Gain Selection | 11 |
| 3.2.7 Factory Defaults | 11 |
| 3.3 Remote Input | 11 |
| 3.4 Adjust Mode | 13 |
| 3.4.1 Two-Point TEACH | 13 |
| 3.4.2 Dynamic TEACH | 14 |
| 3.4.3 Window SET | 16 |
| 3.4.4 Light SET | 17 |
| 3.4.5 Dark SET | 19 |
| 3.4.6 Calibration SET | 21 |
| 3.4.7 Troubleshooting | 22 |
| 4 Specifications | 23 |
| 4.1 Excess Gain Curves | 24 |
| 4.2 Beam Patterns | 26 |
| 4.3 Dimensions | 28 |
| 5 Accessories | 29 |
| 5.1 Quick-Disconnect Cordsets | 29 |
| 6 Banner Engineering Corp. Limited Warranty | 31 |

1 Product Description

Advanced sensor with dual digital displays for use with plastic and glass fiber optic assemblies

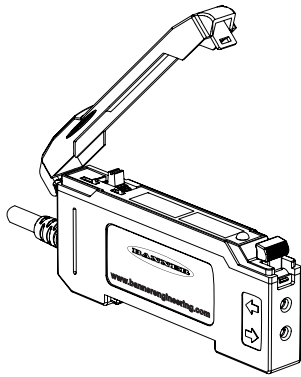

- Best in class response speeds of: 10 μ s, 15 μ s, 50 μ s, 250 μ s, 500 μ s, 1000 μ s and 2000 μ s allow the operator to optimize for fast response, long distance applications, or noisy environments.
- Outstanding color contrast sensitivity; detects 32 levels of gray scale from black to white
- Choose from IR or one of 4 visible beam colors: red, blue, green and white. Depending on the beam color and fiber, the sensor reliably detects the toughest color mark contrasts
- Easy to read dual digital displays show both signal level and threshold simultaneously
- Lever action fiber clamp provides stable, reliable, and trouble-free fiber clamping
- Simple user interface ensures easy sensor set-up and programming via displays and switches/buttons or remote input teach wire
- *Expert* TEACH and SET methods ensure optimal gain and threshold for all applications, especially for high speed or low contrast applications
- User has full control over all operating parameters: threshold, Light Operate or Dark Operate, output timing functions, gain level, and response speed
- Thermally stable electronics shorten start-up time and maintain signal stability during operation
- ECO (economy) display mode reduces amplifier power consumption by 25%
- Cross talk avoidance algorithm allows two sensors to operate in close proximity for many applications
- Sleek 10 mm wide housing mounts to 35 mm DIN rail



WARNING:

- **Do not use this device for personnel protection**
- Using this device for personnel protection could result in serious injury or death.
- This device does not include the self-checking redundant circuitry necessary to allow its use in personnel safety applications. A device failure or malfunction can cause either an energized (on) or de-energized (off) output condition.

1.1 Models

| Model | Sensing Beam Color | Reference Sensing Range ¹ | Outputs | Connector ² |
|--------------|----------------------|--------------------------------------|------------|----------------------------|
| DF-G2-NS-2M | Visible Red | 1100 mm | Single NPN | 2 m (6.5 ft) cable, 4-wire |
| DF-G2-PS-2M | | | Single PNP | |
| DF-G2W-NS-2M | Broad Spectrum White | 550 mm | Single NPN | |
| DF-G2W-PS-2M | | | Single PNP | |
| DF-G2G-NS-2M | Visible Green | 660 mm | Single NPN | |
| DF-G2G-PS-2M | | | Single PNP | |
| DF-G2B-NS-2M | Visible Blue | 770 mm | Single NPN | |
| DF-G2B-PS-2M | | | Single PNP | |

¹ Excess gain = 1, Long Range response speed, opposed mode sensing. PIT46U plastic fiber used for visible LED models, IT.83.3ST5M6 glass fiber used for IR model

² Connector options:

- Models with a quick disconnect require a mating cordset (see [Quick-Disconnect Cordsets](#) on p. 29)
- For 9 m cable, change the suffix 2M to **9M** in the 2 m model number (example, DF-G2-NS-**9M**)
- For 150 mm (6 in) PVC cable with a 4-pin M8 quick disconnect, change the suffix 2M to **Q3** in the 2 m model number (example, DF-G2-NS-**Q3**)
- For 150 mm (6 in) PVC cable with a 4-pin M12 quick disconnect, change the suffix 2M to **Q5** in the 2 m model number (example, DF-G2-NS-**Q5**)
- For integral 4-pin M8 quick disconnect, change the suffix 2M to **Q7** in the 2 m model number (example, DF-G2-NS-**Q7**)

| Model | Sensing Beam Color | Reference Sensing Range ¹ | Outputs | Connector ² |
|---------------|--------------------|--------------------------------------|------------|------------------------|
| DF-G2IR-NS-2M | Infrared | 2100 mm | Single NPN | |
| DF-G2IR-PS-2M | | | Single PNP | |

1.2 Overview

The DF-G2 is an easy-to-use, DIN-rail-mountable fiber optic sensor with best in class response speed and repeatability. It provides high-performance sensing in high speed or low contrast applications where fast response time is required.

The sensor's compact housing has dual digital displays (Red/Green) and a bright output LED for easy programming and status monitoring during operation. The sensor features a single discrete output, either NPN or PNP, by model.

The DF-G2 features improved temperature compensation compared with previous fiber optic sensors. An accessory clamp is available to secure a bank of connected sensors together on a DIN rail (see [Accessories](#) on p. 29).

Figure 1. DF-G2 Model Features

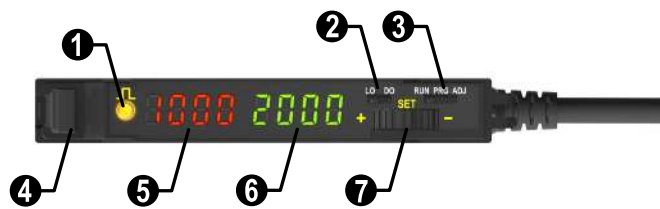

| | |
|---|--------------------------|
| 1 | Output LED |
| 2 | LO/DO Switch |
| 3 | RUN/PRG/ADJ Mode Switch |
| 4 | Lever Action Fiber Clamp |
| 5 | Red Signal Level |
| 6 | Green Threshold |
| 7 | +/-SET/- Rocker Button |

1.3 Top Panel Interface

Opening the dust cover provides access to the top panel interface. The top panel interface consists of the RUN/PRG/ADJ mode switch, LO/DO switch, +/-SET/- rocker button, dual red/green digital displays, and output LED.

RUN/PRG/ADJ Mode Switch



The RUN/PRG/ADJ mode switch puts the sensor in RUN, PRG (Program), or ADJ (Adjust) mode. RUN mode allows the sensor to operate normally and prevents unintentional programming changes via the +/-SET/- button. PRG mode allows the sensor to be programmed through the display driven programming menu (see [Program Mode](#) on p. 8). ADJ mode allows the user to perform Expert TEACH/SET methods and Manual Adjust (see [Adjust Mode](#) on p. 13).

LO/DO Switch



The LO/DO switch is used to select Light Operate or Dark Operate mode. In Light Operate mode, the output is ON when the sensing condition is above the threshold (for Window SET, the output is ON when the sensing condition is inside the window). In Dark Operate mode, the output is ON when the sensing condition is below the threshold (for Window SET, the output is ON when the sensing condition is outside the window).

¹ Excess gain = 1, Long Range response speed, opposed mode sensing. PIT46U plastic fiber used for visible LED models, IT.83.3ST5M6 glass fiber used for IR model

² Connector options:

- Models with a quick disconnect require a mating cordset (see [Quick-Disconnect Cordsets](#) on p. 29)
- For 9 m cable, change the suffix 2M to **9M** in the 2 m model number (example, DF-G2-NS-**9M**)
- For 150 mm (6 in) PVC cable with a 4-pin M8 quick disconnect, change the suffix 2M to **Q3** in the 2 m model number (example, DF-G2-NS-**Q3**)
- For 150 mm (6 in) PVC cable with a 4-pin M12 quick disconnect, change the suffix 2M to **Q5** in the 2 m model number (example, DF-G2-NS-**Q5**)
- For integral 4-pin M8 quick disconnect, change the suffix 2M to **Q7** in the 2 m model number (example, DF-G2-NS-**Q7**)

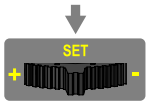
+ /SET/- Rocker Button

The +/SET/- rocker button is a 3-way button. The +/- positions are engaged by rocking the button left/right. The SET position is engaged by clicking down the button while the rocker is in the middle position. All three button positions are used during PRG mode to navigate the display driven programming menu. During ADJ mode, SET is used to perform TEACH/SET methods and +/- are used to manually adjust the threshold(s). The rocker button is disabled during RUN mode, except when using Window SET, see [Window SET](#) on p. 16.

Red/Green Digital Displays

During RUN and ADJ mode, the Red display shows the signal level and the Green display shows the threshold. During PRG mode, both displays are used to navigate the display driven programming menu.

**Output LED**

The output LED provides a visible indication when the output is activated.

2 Installation Instructions

2.1 Mounting Instructions

Mount on a DIN Rail

1. Hook the DIN rail clip on the bottom of the DF-G2 over the edge of the DIN rail (1).
2. Push the DF-G2 up on the DIN rail (1).
3. Pivot the DF-G2 onto the DIN rail, pressing until it snaps into place (2).

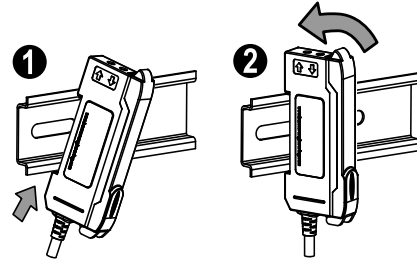

Mount to the Accessory Bracket (SA-DIN-BRACKET)

1. Position the DF-G2 in the SA-DIN-BRACKET.
2. Insert the supplied M3 screws.
3. Tighten the screws.

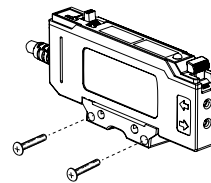

Remove from a DIN rail

1. Push the DF-G2 up on the DIN rail (1).
2. Pivot the DF-G2 away from the DIN rail and remove it (2).

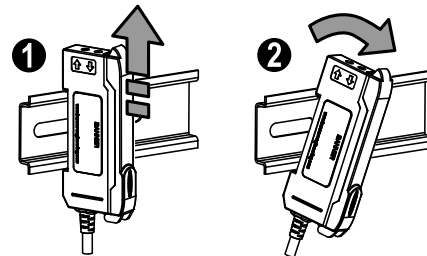

2.2 Installing the Fibers in a DF-Gx Sensor

Follow these steps to install glass or plastic fibers.

1. Open the dust cover.
2. Move the fiber clamp forward to unlock it.
3. Insert the fiber(s) into the fiber port(s) until they stop.
4. Move the fiber clamp backward to lock the fiber(s).
5. Close the dust cover.

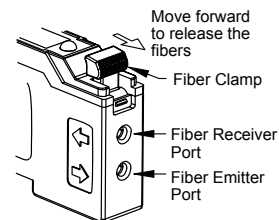

Note: For optimum performance of IR models, if applicable, glass fibers must be used.

2.3 Fiber Adapters



Note: If a thin fiber with less than 2.2 mm outer diameter is used, install the fiber adapter provided with the fiber assembly to ensure a reliable fit in the fiber holder. Align the fibers to the end of the adapters. Banner includes the adapters with all fiber assemblies.

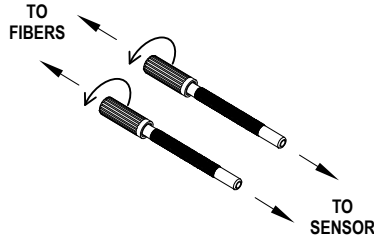

| Fiber Outer Diameter (mm) | Adapter Color |
|---------------------------|-------------------|
| Ø 1.0 | Black |
| Ø 1.3 | Red |
| Ø 2.2 | No adapter needed |

When connecting coaxial-type fiber assemblies to the amplifier, install the single-core (center) fiber to the Transmitter port, and the multi-core (outer) fiber to the Receiver port. This will result in the most reliable detection.

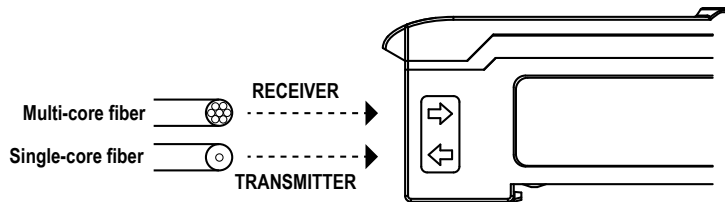

2.4 Wiring Diagrams

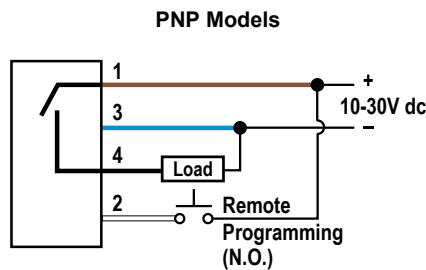
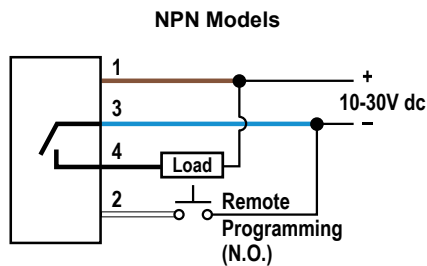

Key

- 1 = Brown
- 2 = White
- 3 = Blue
- 4 = Black

Open lead wires must be connected to a terminal block.

3 Operating Instructions

3.1 Run Mode



Run mode allows the sensor to operate normally and prevents unintentional programming changes. The +/-SET/- rocker button is disabled during RUN mode, except when using Window SET.

3.2 Program Mode

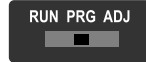

Program (PRG) mode allows the following settings to be programmed in the DF-G2 (refer to Program Mode Flowchart and Remote Input Flowchart for programming). See Factory Default Settings in Specifications.

- Window SET
- Light SET
- Dark SET
- Calibration SET



Note: A **TEACH Selection** must be selected by programming before TEACH/SET methods can be used.

3.2.2 Response Speed RESP SPD

The DF-G2 can be programmed for one of the following Response Speeds:

| Response Speed | Display Range | Crosstalk Avoidance Algorithm |
|--|---------------|-------------------------------|
| 10 μ s (Super High Speed) | 0 – 4000 | Disabled |
| 15 μ s (High Speed) | 0 – 4000 | Disabled |
| 50 μ s (Fast) | 0 – 4000 | Disabled |
| 250 μ s (Standard) | 0 – 4000 | Enabled |
| 500 μ s (Medium Range) | 0 – 9999 | Enabled |
| 1000 μ s (Long Range) | 0 – 9999 | Enabled |
| 2000 μ s (Long Range with immunity to Energy Efficient Lights) | 0 – 9999 | Enabled |

3.2.3 Offset Percent OFFSE Pct

The Offset Percent is used during the Window, Light, or Dark SET methods. The threshold(s) are positioned a programmable % offset from the taught condition.

The allowable range depends upon the Response Speed Mode, as shown below:

| Response Speed | MIN % | MAX % |
|----------------|-------|-------|
| 10 μ s | 5 | 999 |
| 15 μ s | 5 | 999 |
| 50 μ s | 2 | 999 |
| 250 μ s | 2 | 999 |
| 500 μ s | 1 | 999 |
| 1000 μ s | 1 | 999 |
| 2000 μ s | 1 | 999 |

min OFFSE The offset percent can also be programmed to **Minimum Offset**. This allows the DF-G2 to set the threshold(s) as close as possible to the presented condition, but still provide for reliable sensing.



Note: Offset Percent MUST be programmed to **Minimum Offset** for Dark SET to accept conditions of no signal (0 counts).

3.2.4 Auto Thresholds Auto THR

Auto Thresholds can be programmed to be ON/OFF. The Auto Thresholds algorithm continuously tracks slow changes in the taught condition(s), and optimizes the threshold(s) to provide for reliable sensing. For Two-Point and Dynamic TEACH, the algorithm optimizes the threshold to be centered between the light and dark conditions. For Window, Light, and Dark SET, the algorithm optimizes the threshold(s) to maintain the programmed Offset Percent from the taught condition.

- After programming Auto Thresholds to ON, it is highly recommended to re-perform the TEACH/SET method
- Manual Adjustments are disabled when Auto Thresholds are ON
- Auto Thresholds are automatically disabled in Calibration SET (see [Calibration SET](#) on p. 21)

- Severe contamination/changes in the taught condition can prevent the Auto Thresholds algorithm from optimizing the threshold(s). If this occurs, the DF-G2 enters a **Threshold Alert** or **Threshold Error** state. See [Troubleshooting](#) on p. 22 for more explanation.

3.2.5 Delays/Timers OFF dLY OFF 1Shd On dLY On 1Shd

ON/OFF Delays and ON/OFF One-Shot timers can be programmed between 1 - 9999 ms (a value of 0 disables the delay/timer). [Figure 3](#) on p. 11 defines how the delays/timers affect the output behavior.

Some combinations of delays/timers are not allowed. The DF-G2 programming menu automatically disables invalid combinations of delays/timers. The following table shows the allowable combinations of delays/timers:

Figure 3. DF-G2 Delays/Timers

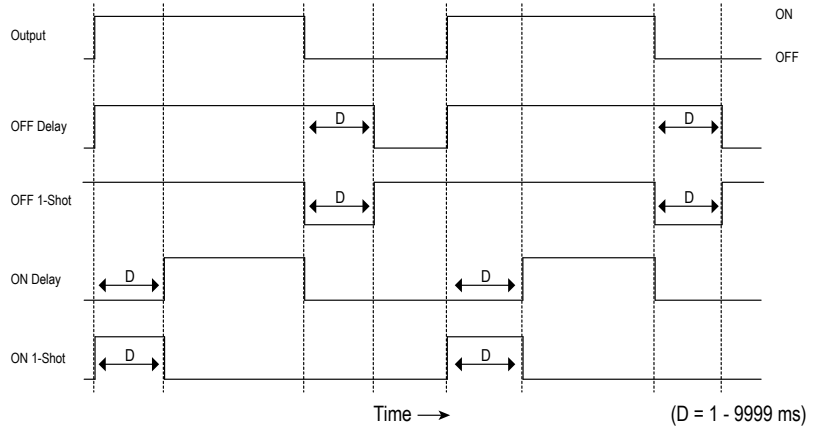

| | OFF Delay | OFF One-Shot Timer | ON Delay | ON One-Shot Timer |
|---------------------------|-----------|--------------------|----------|-------------------|
| OFF Delay | - | OK | OK | N/A |
| OFF One-Shot Timer | OK | - | N/A | N/A |
| ON Delay | OK | N/A | - | OK |
| ON One-Shot Timer | N/A | N/A | OK | - |

3.2.6 Gain Selection GAIn SEL

The DF-G2 can operate in Auto Gain mode or the Gain can be fixed to be in Gain 1...8. In Auto Gain, the DF-G2 optimizes the gain during a TEACH/SET method for the presented condition(s). While viewing the fixed gains in the Gain Selection choice list, the DF-G2 will automatically switch to the selected gain and display the measured signal on the Red display. This allows for easy and quick evaluation of the fixed gain mode.

3.2.7 Factory Defaults Fcty dEF

The Factory Defaults menu allows the DF-G2 to be easily restored back to original factory default settings (see **Factory Default Settings** in Specifications).

Display Readout dISP rERd

The readout of the digital displays can be programmed for the following options:

- Signal/Threshold readout - Numeric (1234) or % (123P)
- ECO mode - Enabled or Disabled (ECO mode dims the displays to reduce current consumption)
- Display Orientation - Normal (1234) or Flipped (ᄀᄀᄀ)

3.3 Remote Input

The remote input may be used to perform TEACH/SET methods and to program the sensor remotely. Connect the white input wire of the sensor to ground (0 V DC), with a remote switch connected between them. Pulse the remote input according to the diagram shown in [Figure 4](#) on p. 12. Follow the instructions in the TEACH/SET sections in [Adjust Mode](#) on p. 13 to perform a TEACH/SET method.

The sensor exits TEACH and remote programming modes after a 60 second timeout. Users may exit TEACH and remote programming modes by setting the remote input low for more than 2 seconds. In either case, the sensor returns to Run mode without saving any new settings.

Figure 4. Remote Input Flowchart

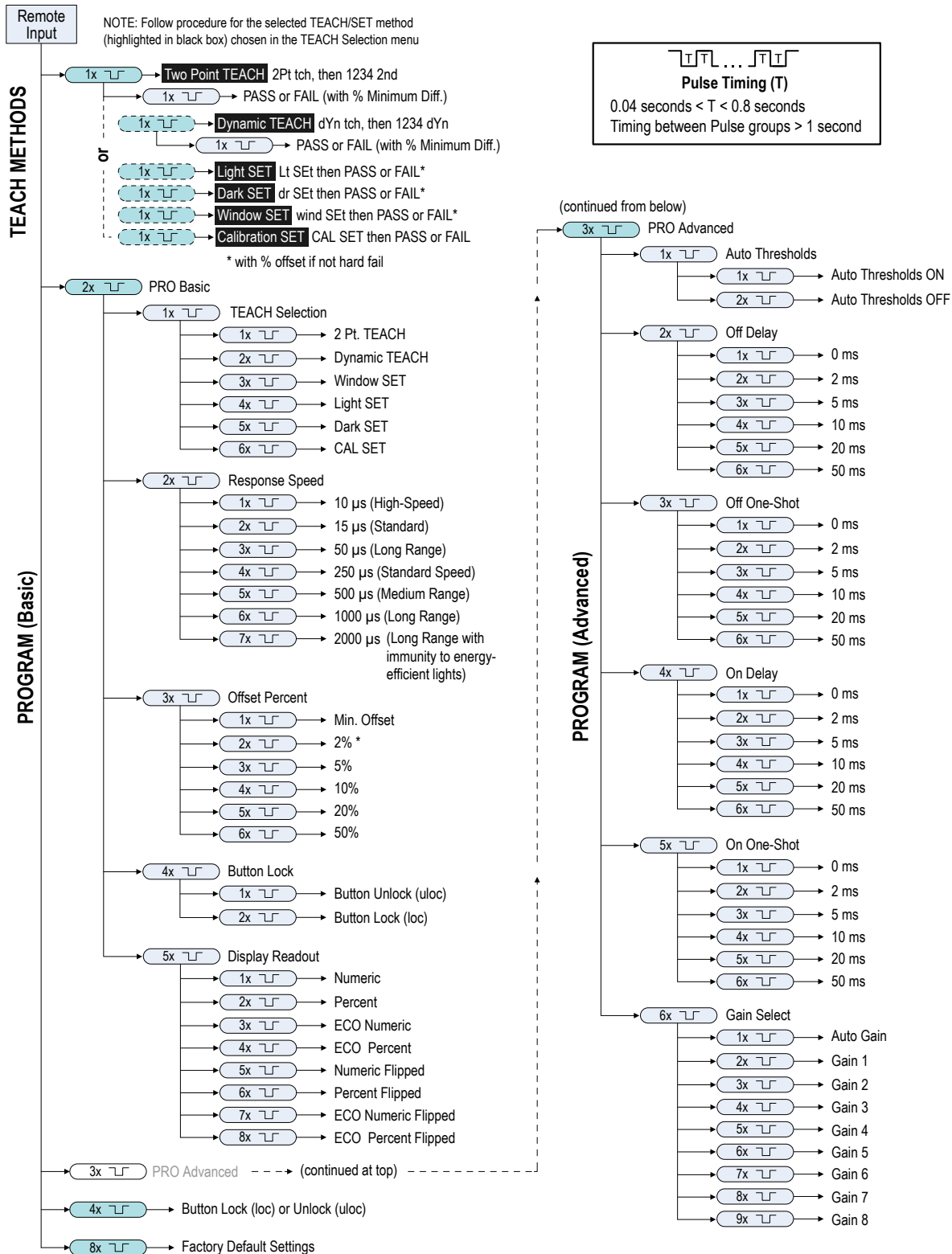

* In Super High-Speed and High-Speed Responses, 2% offset is forced to Min. Offset



3.4 Adjust Mode

Sliding the RUN/PRG/ADJ mode switch to the ADJ position allows the user to perform Expert TEACH/SET methods and Manual Adjustment of the threshold(s).

3.4.1 Two-Point TEACH

- Establishes a single switching threshold
- Threshold can be adjusted by using the "+" and "-" rocker button (Manual Adjust)

Two-Point TEACH is used when two conditions can be presented statically to the sensor. The sensor locates a single sensing threshold (the switch point) midway between the two taught conditions, with the Output ON condition on one side, and the Output OFF condition on the other.

Figure 5. Two-Point TEACH (Light Operate shown)

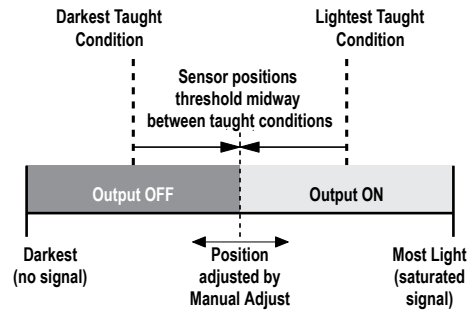

The Output ON and OFF conditions can be reversed by using the LO/DO (Light Operate/ Dark Operate) switch.

Two-Point TEACH and Manual Adjust

Moves switching threshold value up or down to make adjustments

- Slide Mode switch to ADJ to enter Adjust mode
- Press "+" to increase; press "-" to decrease
 - GREEN display shows the switching threshold value
 - 2 seconds after adjustment, the GREEN display will flash 3 times to confirm
- Slide Mode switch to RUN to complete operation

Follow these steps to perform a Two-Point TEACH:



Note: TEACH Selection must be programmed to **2Pt tcH**.



1. Enter Adjust mode.

| Method | Action | Result |
|---------------------------|---|--|
| SET Button ³ | Set the Mode switch to ADJ. | Display: Red - Signal Level; Green - Threshold |
| Remote Input ⁴ | No action is required; sensor is ready for the Two-Point TEACH method | |

2. Teach the first condition.

³ SET Button: 0.04 seconds ≤ "Click" ≤ 0.8 seconds

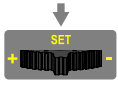

⁴ Remote Input: 0.04 seconds ≤ T ≤ 0.8 seconds

| Method | Action | Result |
|--------------|--|---|
| SET Button | a. Present the first condition. b. Click the SET rocker button. |  Display: Flashes "2Pt tch" then holds on "1234 2nd"  |
| Remote Input | a. Present the first condition. b. Single-pulse the remote input. |  |

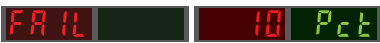
3. Teach the second condition.

| Method | Action | Result |
|--------------|---|---|
| SET Button | a. Present the second condition. b. Click the SET rocker button. | TEACH Accepted Displays alternate "PASS" and % Minimum Difference ⁵ ; Sensor returns to Adjust mode  |
| Remote Input | a. Present the second condition. b. Single-pulse the remote input. | TEACH Not Accepted Displays alternate "FAIL" and % Minimum Difference ⁵ ; Sensor returns to Adjust mode  |

4. Return to Run mode.

| Method | Action | Result |
|--------------|---|---|
| SET Button | Move the Mode switch to RUN |  Display: Red - Signal Level; Green - Threshold  |
| Remote Input | No action is required; sensor returns to RUN mode automatically | |

3.4.2 Dynamic TEACH

- Teaches on-the-fly
- Establishes a single switching threshold
- Threshold can be adjusted using "+" and "-" rocker button (Manual Adjust)

Dynamic TEACH is best used when a machine or process may not be stopped for teaching. The sensor learns during actual sensing conditions, taking multiple samples of the light and dark conditions and automatically setting the threshold at the optimum level.

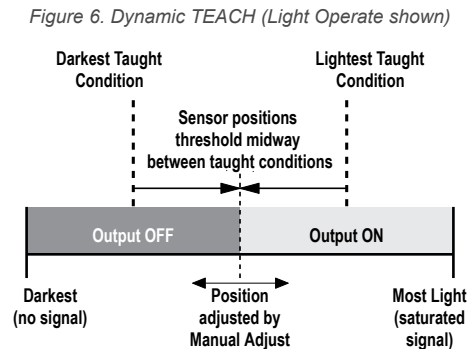

The output ON and OFF conditions can be reversed using the LO/DO switch.

⁵ See [Troubleshooting](#) on p. 22 for more explanation of the % Minimum Difference displayed after the Two-Point TEACH method.

Dynamic TEACH and Manual Adjust

- Slide Mode switch to ADJ to enter Adjust mode
- Press "+" to increase; press "-" to decrease
 - GREEN display shows the switching threshold value
 - 2 seconds after adjustment, GREEN display will flash 3 times to confirm
- Slide Mode switch to RUN to complete operation



Remember: Manual adjustments are disabled when Auto Thresholds are ON

Follow these steps to perform **Dynamic TEACH**:



Note: TEACH Selection must be programmed to **dYn tch**.

1. Enter Adjust Mode.

| Method | Action | Result |
|---------------------------|--|---|
| SET Button ⁶ | Set Mode switch to ADJ | Display: Red - Signal Level; Green - Threshold  |
| Remote Input ⁷ | No action required; sensor is ready for Dynamic TEACH method | |

2. Enter Dynamic TEACH.

| Method | Action | Result |
|--------------|-----------------------------|---|
| SET Button | Click the SET rocker button | Display: Flashes "dYn tch" then holds on "1234 dYn"  |
| Remote Input | Single-pulse remote input | |

3. Present ON and OFF Conditions.

| Method | Action | Result |
|--------------|-------------------------------|---|
| SET Button | Present ON and OFF conditions | Display: Red - Signal Level; Green - Threshold  |
| Remote Input | Present ON and OFF conditions | |

4. Exit Dynamic TEACH.

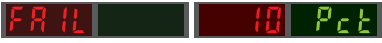

| Method | Action | Result |
|--------------|-----------------------------|--|
| SET Button | Click the SET rocker button | TEACH Accepted Displays alternate "PASS" with % Minimum Difference ⁸ , Sensor returns to Adjust mode  TEACH Not Accepted Displays alternate "FAIL" with % Minimum Difference ⁸ , Sensor returns to Adjust mode  |
| Remote Input | Single-pulse remote input | |

⁶ SET Button: 0.04 seconds ≤ "Click" ≤ 0.8 seconds

⁷ Remote Input: 0.04 seconds ≤ T ≤ 0.8 seconds

⁸ See [Troubleshooting](#) on p. 22 for more explanation of the % Minimum Difference displayed after the Dynamic TEACH method.

5. Return to RUN Mode.

| Method | Action | Result |
|--------------|---|---|
| SET Button | Move Mode switch to RUN  | Display: Red - Signal Level; Green - Threshold  |
| Remote Input | No action required; sensor returns to RUN mode automatically | |

3.4.3 Window SET

- Sets window thresholds that extend a programmable % offset above and below the presented condition
- All other conditions (lighter or darker) cause the output to change state
- Sensing window center can be adjusted using "+" and "-" rocker button (Manual Adjust)
- Recommended for applications where a product may not always appear in the same place, or when other signals may appear
- See Program Mode for programming the Offset Percent setting

A single sensing condition is presented, and the sensor positions window thresholds a programmable % offset above and below the presented condition. In LO mode, Window SET designates a sensing window with the Output ON condition inside the window, and the Output OFF conditions outside the window.

Figure 7. Window SET (Light Operate shown)

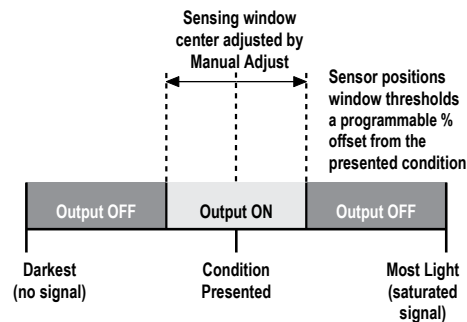

Output ON and OFF conditions can be reversed using the LO/DO switch.

Moves sensing window center value up or down to make adjustments

- Slide Mode switch to ADJ to enter Adjust mode
- Press "+" to increase; press "-" to decrease
 - GREEN display shows the sensing window center value
 - 2 seconds after adjustment, the GREEN display will flash 3 times to confirm
- Slide Mode switch to RUN to complete operation





Remember: Manual adjustments are disabled when Auto Thresholds are ON

Follow these steps to perform a Window SET:







Note: TEACH Selection must be programmed to **wind SET**.

1. Enter Adjust Mode

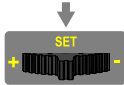
| Method | Action | Result |
|----------------------------|---|---|
| SET Button ⁹ | Set Mode switch to ADJ  | Display: Red - Signal Level; Green - Threshold  |
| Remote Input ¹⁰ | No action required; sensor is ready for Window SET method | |

2. SET Sensing Condition

| Method | Action | Result |
|--------------|--|--|
| SET Button | <ul style="list-style-type: none"> Present sensing condition Click the SET rocker button  | <p>Threshold Condition Accepted Displays read "wInd SET" then alternate "PASS" with % Offset ¹¹; Sensor returns to Adjust mode</p>  |
| Remote Input | <ul style="list-style-type: none"> Present sensing condition Single-pulse the remote input  | <p>Threshold Condition Not Accepted Displays read "wInd SET" then alternate "FAIL" with minimum % Offset ¹¹ for sensing condition; Sensor returns to Adjust mode</p>  |

3. Return to RUN Mode



| Method | Action | Result |
|--------------|--|--|
| SET Button | Move Mode switch to Run  | Display: Red - Signal Level; Green - Window Center (see Figure 8 on p. 17 for instructions on how to display upper and lower thresholds) |
| Remote Input | No action required; sensor returns to Run mode automatically |  |

Figure 8. Upper and Lower Thresholds

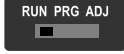

3.4.4 Light SET

- Sets a threshold a programmable % offset below the presented condition
- Changes output state on any condition darker than the threshold condition
- Threshold can be adjusted using "+" and "-" rocker button (Manual Adjust)

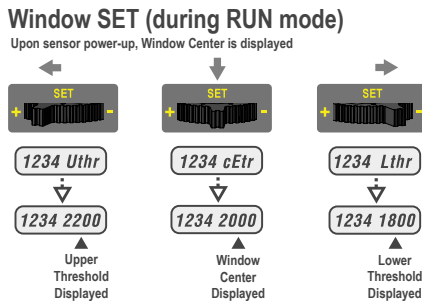
⁹ SET Button: 0.04 seconds ≤ "Click" ≤ 0.8 seconds
¹⁰ Remote Input: 0.04 seconds ≤ T ≤ 0.8 seconds
¹¹ See [Troubleshooting](#) on p. 22 for more explanation of the % Offset displayed after the Window SET method

- Recommended for applications where only one condition is known, for example a stable light background with varying darker targets
- See Program Mode for programming the Offset Percent setting

A single sensing condition is presented, and the sensor positions a threshold a programmable % offset below the presented condition. When a condition darker than the threshold is sensed, the output either turns ON or OFF, depending on the LO/DO setting.

Figure 9. Light SET (Light Operate shown)

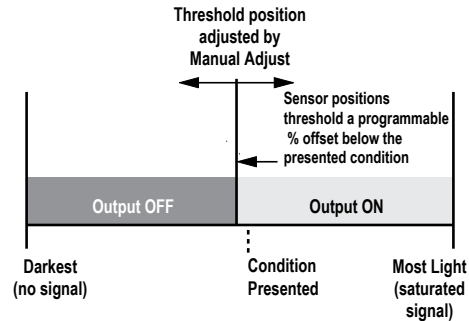

Light SET and Manual Adjust

Moves switching threshold value up or down to make adjustments

- Slide Mode switch to ADJ to enter Adjust mode
- Press "+" to increase; press "-" to decrease
 - GREEN display shows the switching threshold value
 - 2 seconds after adjustment, the GREEN display will flash 3 times to confirm
- Slide Mode switch to RUN to complete operation





Remember: Manual adjustments are disabled when Auto Thresholds are ON

Follow these steps to perform a Light SET:



Note: TEACH Selection must be programmed to Lt SET.

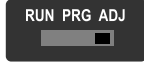



1. Enter Adjust Mode

| Method | Action | Result |
|----------------------------|--|---|
| SET Button ¹² | Set Mode switch to ADJ  | Display: Red - Signal Level; Green - Threshold  |
| Remote Input ¹³ | No action is required; sensor is ready for Light SET method | |

2. SET Sensing Condition

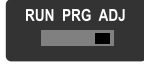
¹² SET Button: 0.04 seconds ≤ "Click" ≤ 0.8 seconds

¹³ Remote Input: 0.04 seconds ≤ T ≤ 0.8 seconds

| Method | Action | Result |
|--------------|--|--|
| SET Button | <ul style="list-style-type: none"> Present sensing condition Click the SET rocker button  | <p>Threshold Condition Accepted Displays read "Lt SET" then alternate "PASS" with % Offset ¹⁴; Sensor returns to Adjust mode</p>  |
| Remote Input | <ul style="list-style-type: none"> Present sensing condition Single-pulse the remote input  | <p>Threshold Condition Not Accepted Displays read "Lt SET" then alternate "FAIL" with minimum % Offset ¹⁴ for sensing condition; Sensor returns to Adjust mode</p>  |

3. Return to RUN Mode

| Method | Action | Result |
|--------------|--|---|
| SET Button | Move Mode switch to RUN |  Display: Red - Signal Level; Green - Threshold  |
| Remote Input | No action required; sensor returns to RUN mode automatically | |

3.4.5 Dark SET

- Sets a threshold a programmable % offset above the presented condition
- Any condition lighter than the threshold condition causes the output to change state
- Threshold can be adjusted using "+" and "-" rocker button (Manual Adjust)
- Recommended for applications where only one condition is known, for example a stable dark background with varying lighter targets
- See Program Mode for programming the Offset Percent setting

 **Note:** Offset Percent MUST be programmed to **Minimum Offset** to accept conditions of no signal (0 counts).

A single sensing condition is presented, and the sensor positions a threshold a programmable % offset above the presented condition. When a condition lighter than the threshold is sensed, the output either turns ON or OFF, depending on the LO/DO setting.

Figure 10. Dark SET (Light Operate shown)

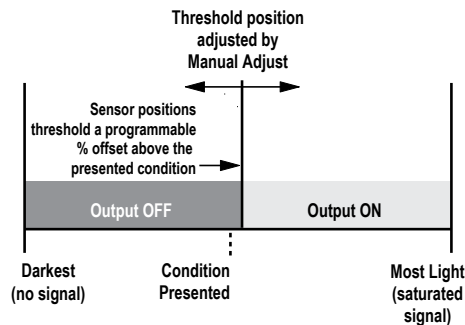

¹⁴ See [Troubleshooting](#) on p. 22 for more explanation of the % Offset displayed after the Light SET method

Dark SET and Manual Adjust

Moves switching threshold value up or down to make adjustments

- Slide Mode switch to ADJ to enter Adjust mode
- Press "+" to increase; press "-" to decrease
 - GREEN display shows the switching threshold value
 - 2 seconds after adjustment, the GREEN display will flash 3 times to confirm
- Slide Mode switch to RUN to complete operation



Remember: Manual adjustments are disabled when Auto Thresholds are ON

Follow these steps to perform a Dark SET:





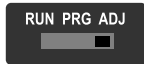

Note: TEACH Selection must be programmed to **dr SET**.

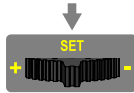

1. Enter Adjust Mode.

| Method | Action | Result |
|----------------------------|--|---|
| SET Button ¹⁵ | Set Mode switch to ADJ  | Display: Red - Signal Level; Green - Threshold  |
| Remote Input ¹⁶ | No action required; sensor is ready for Dark SET method | |

2. SET Sensing Condition.

| Method | Action | Result |
|--------------|--|---|
| SET Button | <ul style="list-style-type: none"> • Present sensing condition • Click the SET rocker button  | <p>Threshold Condition Accepted Displays read "dr SET" then alternate "PASS" with % Offset ¹⁷; Sensor returns to Adjust mode</p>  |
| Remote Input | <ul style="list-style-type: none"> • Present sensing condition • Single-pulse the remote input  | <p>Threshold Condition Not Accepted Displays read "dr SET" then alternate "FAIL" with minimum % Offset ¹⁷ for sensing condition; Sensor returns to Adjust mode</p>   |

3. Return to RUN Mode.

| Method | Action | Result |
|--------------|---|---|
| SET Button | Move Mode switch to RUN  | Display: Red - Signal Level; Green - Threshold  |
| Remote Input | No action required; sensor returns to RUN mode automatically | |

¹⁵ SET Button: 0.04 seconds ≤ "Click" ≤ 0.8 seconds

¹⁶ Remote Input: 0.04 seconds ≤ T ≤ 0.8 seconds

¹⁷ See [Troubleshooting](#) on p. 22 for more explanation of the % Offset displayed after the Dark SET method

3.4.6 Calibration SET

- Sets a threshold exactly at the presented condition
- Threshold can be adjusted using "+" and "-" rocker button (Manual Adjust)

A single sensing condition is presented, and the sensor positions a threshold exactly at the presented condition. When a condition lighter than the threshold is sensed, the output either turns ON or OFF, depending on the LO/DO setting.

Figure 11. Calibration SET (Light Operate shown)

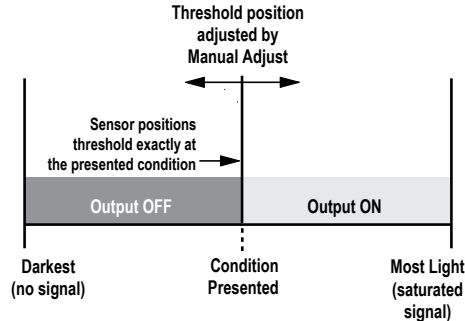

Calibration SET and Manual Adjust

Moves switching threshold value up or down to make adjustments

- Slide Mode switch to ADJ to enter Adjust mode
- Press "+" to increase; press "-" to decrease
 - GREEN display shows the switching threshold value
 - 2 seconds after adjustment, the GREEN display will flash 3 times to confirm
- Slide Mode switch to RUN to complete operation



Remember: Auto Thresholding is automatically disabled in Calibration SET

Follow these steps to perform a Calibration SET:







Note: TEACH Selection must be programmed to **CAL SET**.

1. Enter Adjust Mode

| Method | Action | Result |
|----------------------------|---|---|
| SET Button ¹⁸ | <ul style="list-style-type: none"> • Set Mode switch to ADJ  | Display: Red - Signal Level; Green - Threshold  |
| Remote Input ¹⁹ | No action required; sensor is ready for Calibration SET method | |



2. SET Sensing Condition

| Method | Action | Result |
|--------------|--|--|
| SET Button | <ul style="list-style-type: none"> • Present sensing condition • Click the SET rocker button  | Threshold Condition Accepted Displays read "cAL SET" then flashes "PASS"; Sensor returns to Adjust mode  |
| Remote Input | <ul style="list-style-type: none"> • Present sensing condition • Single-pulse the remote input  | Threshold Condition Unacceptable Displays read "cAL SET" then flashes "FAIL"; Sensor returns to Adjust mode  |

¹⁸ SET Button: 0.04 seconds ≤ "Click" ≤ 0.8 seconds

¹⁹ Remote Input: 0.04 seconds ≤ T ≤ 0.8 seconds

3. Return to RUN Mode

| Method | Action | Result |
|--------------|---|---|
| SET Button | Move Mode switch to RUN  | Display: Red - Signal Level; Green - Threshold  |
| Remote Input | No action required; sensor returns to RUN mode automatically | |

3.4.7 Troubleshooting

Manual Adjustments Disabled

Manual adjustments are disabled when Auto Thresholds are ON. If a manual adjustment is attempted while Auto Thresholds are ON, the Green display will flash .

Percent Minimum Difference after TEACH

The Two-Point and Dynamic TEACH methods will flash a % minimum difference on the displays after a PASS or FAIL.

| Value | PASS/FAIL | Description |
|-------------|-----------|--|
| 0 to 99% | FAIL | The difference of the taught conditions does not meet the required minimum |
| 100 to 300% | PASS | The difference of the taught conditions just meets/exceeds the required minimum, minor sensing variables may affect sensing reliability |
| 300 to 600% | PASS | The difference of the taught conditions sufficiently exceeds the required minimum, minor sensing variables will not affect sensing reliability |
| 600% + | PASS | The difference of the taught conditions greatly exceeds the required minimum, very stable operation |



Percent Offset after SET

The Window, Dark, and Light SET methods will flash a % offset on the displays after a PASS or FAIL.

| SET Result | % Offset Meaning |
|-------------------------|---|
| PASS (with % Offset) | Displays the % offset used for the SET method |
| FAIL (with % Offset) | Displays the minimum required % offset necessary to PASS the SET method |
| FAIL (without % Offset) | Presented condition cannot be used for the SET method |

Threshold Alert or Threshold Error

Severe contamination/changes in the taught condition can prevent the Auto Thresholds algorithm from optimizing the threshold(s).

| State | Display | Description | Corrective Action |
|-----------------|--|---|---|
| Threshold Alert | Alternates  and  | The threshold(s) cannot be optimized, but the sensor's output will still continue to function | Cleaning/correcting the sensing environment and/or a re-teach of the sensor is highly recommended |
| Threshold Error |  | The threshold(s) cannot be optimized, and the sensor's output will stop functioning | Cleaning/correcting the sensing environment and/or a re-teach of the sensor is required |

4 Specifications

Sensing Beam

- DF-G2: Visible red, 635 nm
- DF-G2W: Broad spectrum white, 450 nm to 650 nm
- DF-G2B: Visible blue, 470 nm
- DF-G2G: Visible green, 525 nm
- DF-G2IR: Infrared, 850 nm

Supply Voltage

10 V DC to 30 V DC Class 2 (10% maximum ripple)

Power and Current Consumption (exclusive of load)

Standard display mode: 960 mW, Current consumption < 40 mA at 24 V DC

ECO display mode: 720 mW, Current consumption < 30 mA at 24 V DC

Supply Protection Circuitry

Protected against reverse polarity and transient overvoltages

Delay at Power-Up

500 milliseconds maximum; outputs do not conduct during this time

Output Configuration

1 NPN or 1 PNP output, depending on model

Output Rating

100 mA maximum load (derate 1 mA per °C above 30 °C)

OFF-state leakage current: < 5 µA at 30 V DC;

ON-state saturation voltage: NPN : < 1.5 V; PNP : < 2 V

Output Protection

Protected against output short-circuit, continuous overload, transient overvoltages, and false pulse on power-up

Output Response Time

Super High Speed: 10 µs

High Speed: 15 µs

Fast: 50 µs

Standard: 250 µs

Medium Range: 500 µs

Long Range: 1000 µs

Long Range with immunity to Energy Efficient Lights: 2000 µs

Repeatability

Super High Speed: 5 µs

High Speed: 5 µs

Fast: 12 µs

Standard: 50 µs

Medium Range: 80 µs

Long Range: 165 µs

Long Range with immunity to Energy Efficient Lights: 165 µs

Required Overcurrent Protection



WARNING: Electrical connections must be made by qualified personnel in accordance with local and national electrical codes and regulations.

Overcurrent protection is required to be provided by end product application per the supplied table.

Overcurrent protection may be provided with external fusing or via Current Limiting, Class 2 Power Supply.

Supply wiring leads < 24 AWG shall not be spliced.

For additional product support, go to www.bannerengineering.com.

| Supply Wiring (AWG) | Required Overcurrent Protection (Amps) |
|---------------------|--|
| 20 | 5.0 |
| 22 | 3.0 |
| 24 | 2.0 |
| 26 | 1.0 |
| 28 | 0.8 |
| 30 | 0.5 |

Adjustments

3-way RUN/PRG/ADJ Mode Switch

2-way LO/DO Switch

3-way +/SET/- Rocker Button

- Expert-style teaching (Two-Point and Dynamic TEACH, Light/Dark/Window/Calibration SET)
- Manually adjust sensitivity (from "+" and "-" rocker button only)
- Response Speed, TEACH Selection, Offset Percent, Auto Thresholds, Delays/Timers, Display Readout, Gain Selection, Factory Defaults (from top panel or remote input)
- Top panel interface lockout (from remote input only)

Factory Default Settings:

| Setting | Factory Default |
|-----------------|---|
| Threshold | 2011 |
| TEACH Selection | Two-Point TEACH |
| Response Speed | Standard: 250 µs |
| Offset Percent | 10% |
| Auto Thresholds | OFF |
| OFF Delay | 0 (Disabled) |
| OFF One-Shot | 0 (Disabled) |
| ON Delay | 0 (Disabled) |
| ON One-Shot | 0 (Disabled) |
| Display Readout | Numeric, ECO disabled, Normal Orientation |
| Gain Selection | Auto Gain |

Indicators

Red 4-digit Display: Signal Level

Green 4-digit Display: Threshold

(In Program Mode, Red and Green displays are used for programming menus)

Yellow LED: Output conducting

Construction

Black ABS/polycarbonate alloy (UL94 V-0 rated) housing, clear polycarbonate cover

Connections

PVC-jacketed 2 m or 9 m (6.5 ft. or 30 ft.) 4-wire integral cable; or integral 4-pin M8 quick disconnect; or 150 mm (6 in.) cable with a 4-pin M12 quick disconnect; or 150 mm (6 in.) cable with a 4-pin M8 quick disconnect.

Environmental Rating

IP50, NEMA 1

Operating Conditions

Temperature: -10 °C to +55 °C (+14 °F to +131 °F)

Storage Temperature: -20 °C to +85 °C (-4 °F to +185 °F)

Humidity: 90% at +60 °C maximum relative humidity (non-condensing)

Certifications



4.1 Excess Gain Curves

The excess gain curves shown are for the standard red LED emitter models. Multiplication factors for the other colored LEDs (with respect to the red LED values) are:

- White 0.5
- Green 0.6
- Blue 0.7
- IR850—see IR850 excess gain curves

The data in the charts that is labeled for the Long Range application apply to both the 1000 μ s and 2000 μ s response speeds.

Figure 12. PIT16U-Opposed Mode

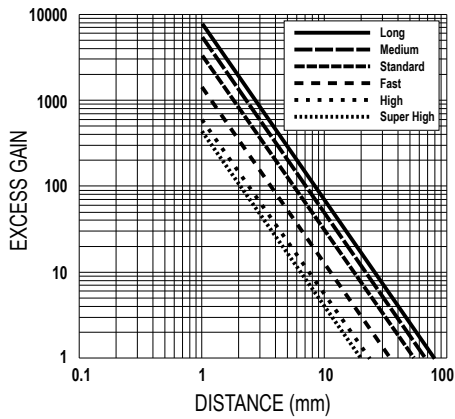

Figure 13. PBT16U-Diffuse Mode

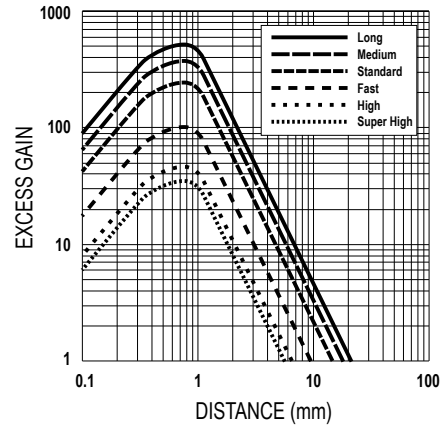

Figure 14. PIT26U-Opposed Mode

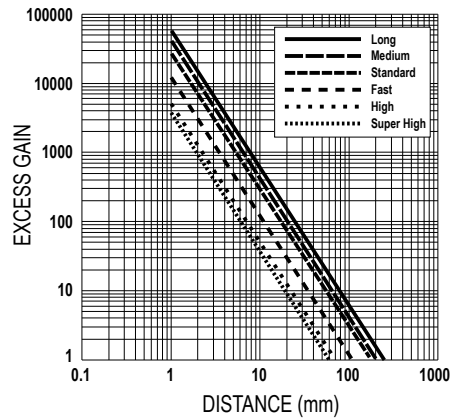

Figure 15. PBT26U-Diffuse Mode

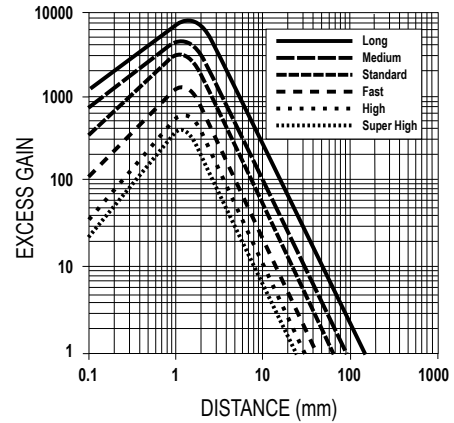

Figure 16. PIT46U-Opposed Mode

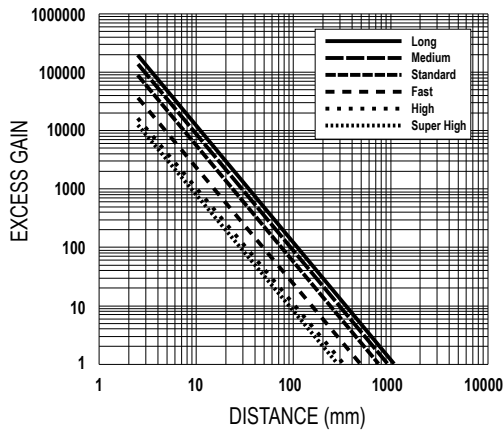

Figure 17. PBT46U-Diffuse Mode

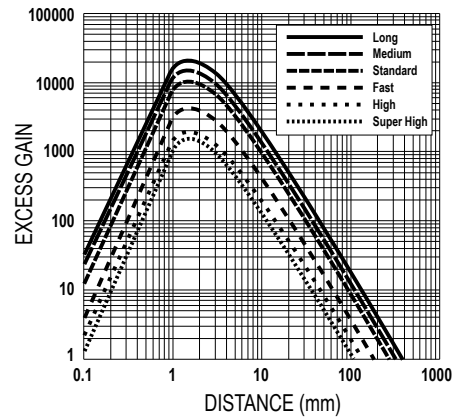

Figure 18. PIT66U-Opposed Mode

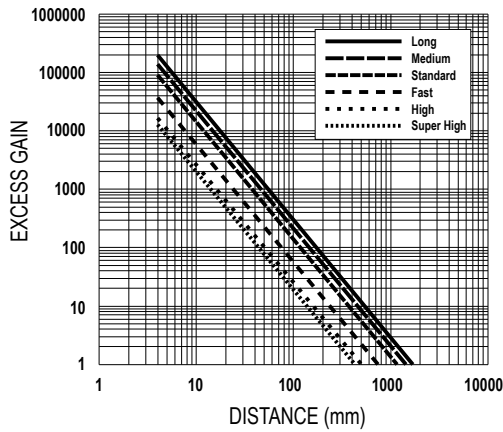

Figure 19. PBT66U-Diffuse Mode

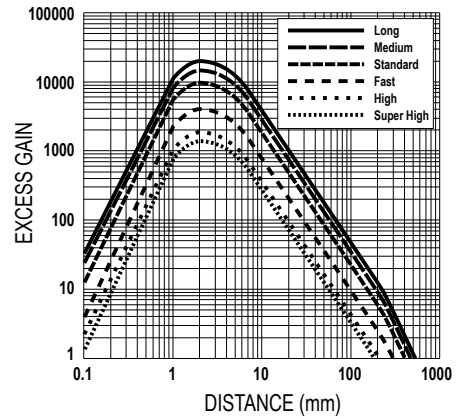

Figure 20. IR850-Opposed Mode

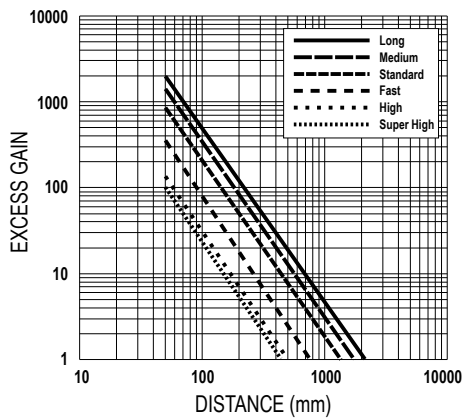
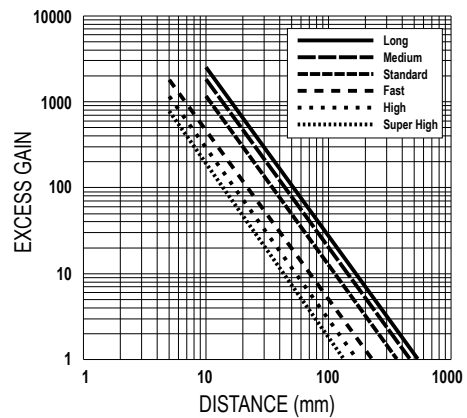

Figure 21. IR850-Diffuse Mode



Note: IT.83.3ST5M6 glass fiber used for opposed mode



Note: BTC1.13.4ST5M6 glass fiber used for diffuse mode

4.2 Beam Patterns

The beam patterns shown are for the standard red LED emitter models. Multiplication factors for the other colored LEDs (with respect to the red LED values) are:

- White 0.5
- Green 0.6
- Blue 0.7
- IR850—see the IR850 beam patterns

The data in the charts that is labeled for the Long Range application apply to both the 1000 μ s and 2000 μ s response speeds.

Figure 22. PIT16U-Opposed Mode

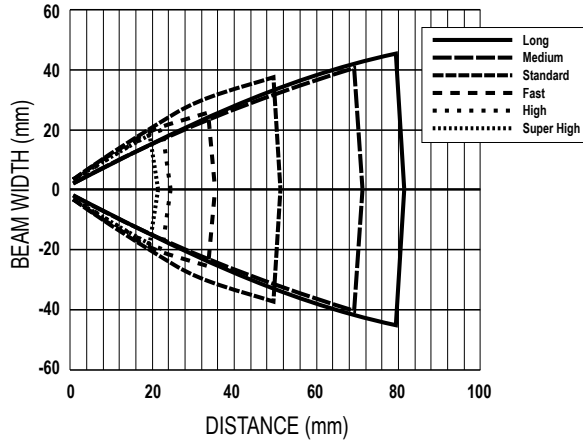

Figure 23. PBT16U-Diffuse Mode

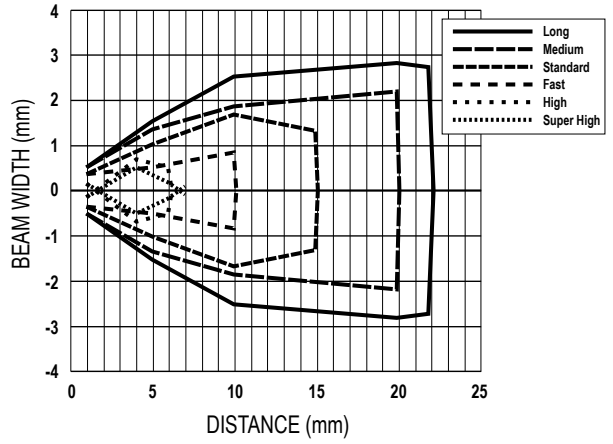

Figure 24. PIT26U-Opposed Mode

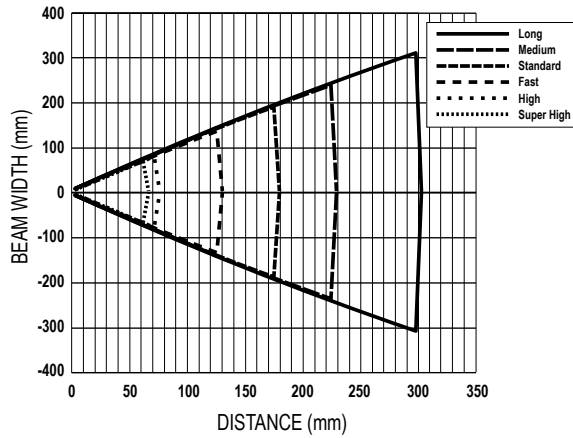

Figure 25. PBT26U-Diffuse Mode

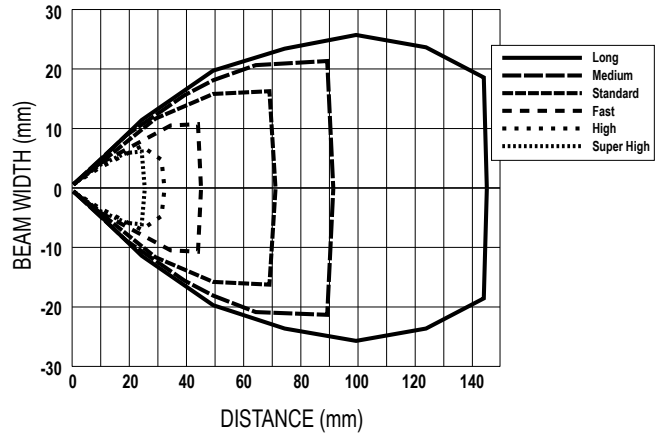

Figure 26. PIT46U-Opposed Mode

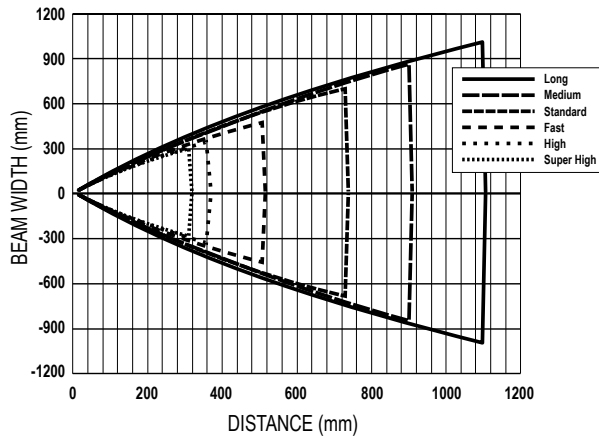

Figure 27. PBT46U-Diffuse Mode

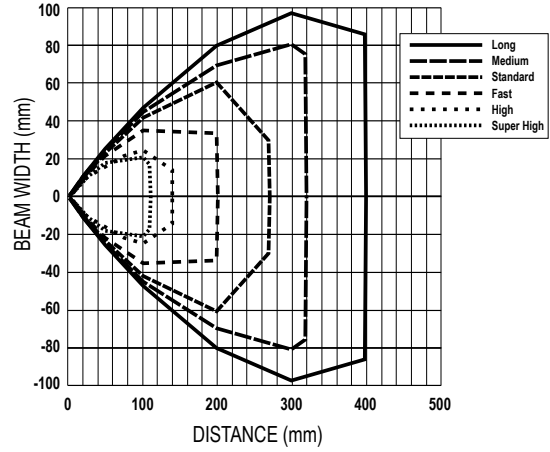

Figure 28. PIT66U-Opposed Mode

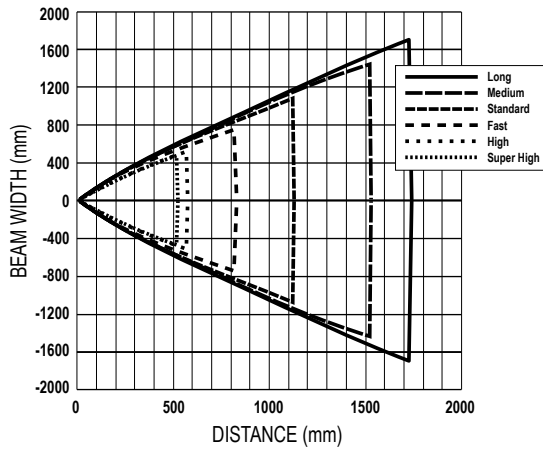

Figure 29. PBT66U-Diffuse Mode

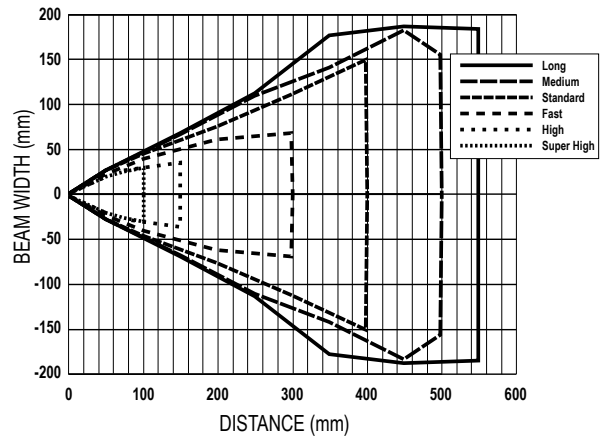
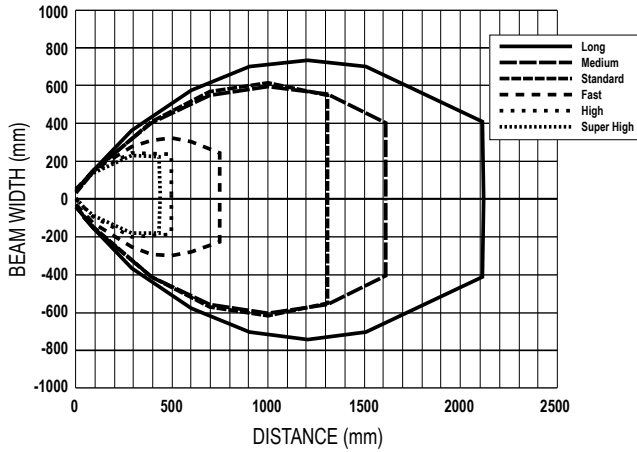
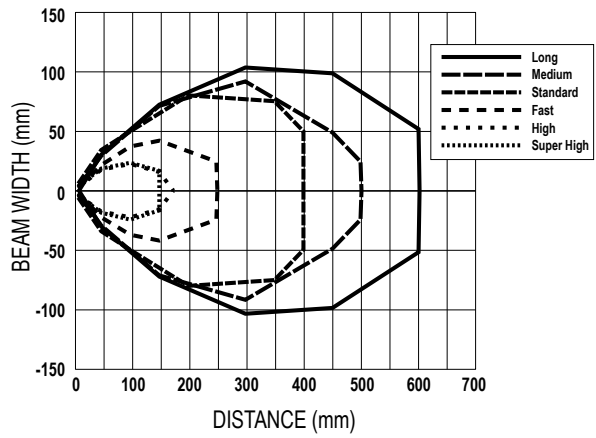

Figure 30. IR850-Opposed Mode



Note: IT.83.3ST5M6 glass fiber used for opposed mode

Figure 31. IR850-Diffuse Mode



Note: BTC1.13.4ST5M6 glass fiber used for diffuse mode

4.3 Dimensions

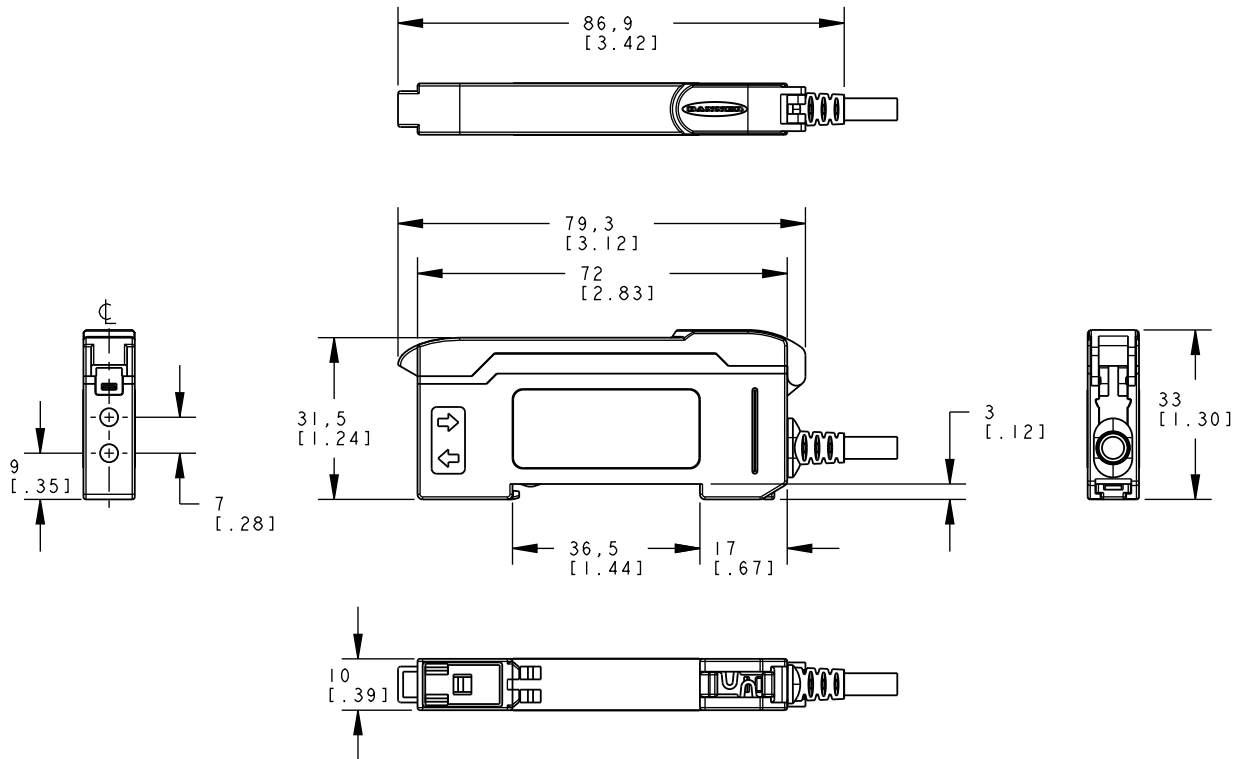

5 Accessories

DIN-35-..

35 mm DIN Rail

| Model | Length |
|------------|--------|
| DIN-35-70 | 70 |
| DIN-35-105 | 105 |
| DIN-35-140 | 140 |
| DIN-35-180 | 180 |
| DIN-35-220 | 220 |

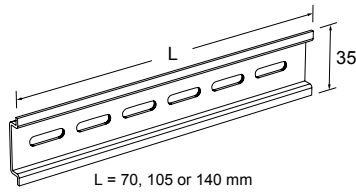

Hole center spacing: 35.1

Hole size: 25.4 x 5.3

SA-DIN-CLAMP

- Pair of metal DIN rail end stops; slide onto DIN rail at either side of the sensor stack
- Combination (#2 Phillips, #8 standard slotted) set screw

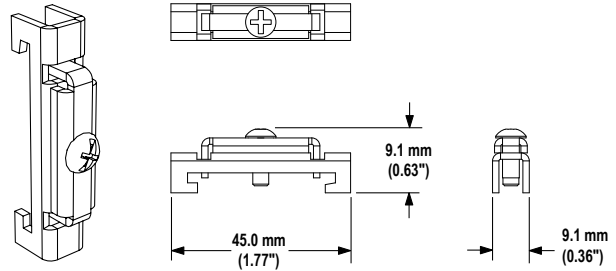

SA-DIN-BRACKET

- Plastic bracket with mounting screws

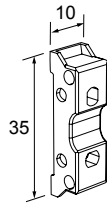

Hole center spacing: A = 16, B = 25.4, C = 15.2

Hole size: A = \varnothing 3.2, B = \varnothing 3.3, C = \varnothing 4.4

SA-DIN-BRACKET-10

- Package of 10 plastic brackets with mounting screws

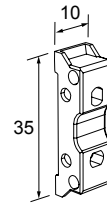

Hole center spacing: A = 16, B = 25.4, C = 15.2

Hole size: A = \varnothing 3.2, B = \varnothing 3.3, C = \varnothing 4.4

5.1 Quick-Disconnect Cordsets

All measurements are listed in millimeters, unless noted otherwise.

| 4-Pin Threaded M12 Cordsets—Single Ended | | | | | |
|--|----------------|-------------|------------|-----------------|---|
| Model | Length | Style | Dimensions | Pinout (Female) | |
| MQDC-406 | 2 m (6.56 ft) | Straight | | | 1 = Brown 2 = White 3 = Blue 4 = Black |
| MQDC-415 | 5 m (16.4 ft) | | | | |
| MQDC-430 | 9 m (29.5 ft) | | | | |
| MQDC-450 | 15 m (49.2 ft) | | | | |
| MQDC-406RA | 2 m (6.56 ft) | Right-Angle | | | |
| MQDC-415RA | 5 m (16.4 ft) | | | | |
| MQDC-430RA | 9 m (29.5 ft) | | | | |
| MQDC-450RA | 15 m (49.2 ft) | | | | |

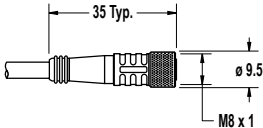
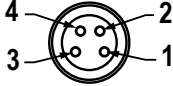
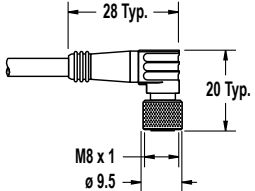
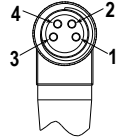
| 4-Pin Threaded M8 Cordsets—Single Ended | | | | | |
|---|------------------|-------------|---|---|---|
| Model | Length | Style | Dimensions | Pinout (Female) | |
| PKG4M-2 | 2.04 m (6.68 ft) | Straight |  |  | 1 = Brown 2 = White 3 = Blue 4 = Black |
| PKG4M-5 | 5 m (16.4 ft) | | | | |
| PKG4M-9 | 9.04 m (29.6 ft) | | | | |
| PKW4M-2 | 2 m (6.56 ft) | Right Angle |  |  | |
| PKW4M-5 | 5 m (16.4 ft) | | | | |
| PKW4M-9 | 9 m (29.5 ft) | | | | |

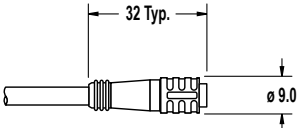
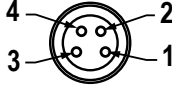
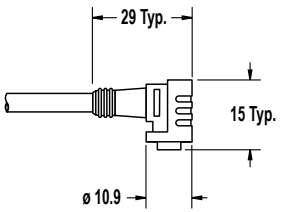
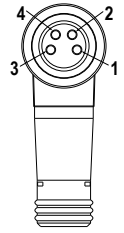
| 4-Pin Snap-on M8 Cordsets—Single Ended | | | | | |
|--|------------------|-------------|---|---|---|
| Model | Length | Style | Dimensions | Pinout (Female) | |
| PKG4-2 | 2.03 m (6.66 ft) | Straight |  |  | 1 = Brown 2 = White 3 = Blue 4 = Black |
| PKG4-5 | 5.03 m (16.5 ft) | | | | |
| PKG4-10 | 10 m (32.9 ft) | | | | |
| PKW4Z-2 | 2 m (6.56 ft) | Right-Angle |  |  | |
| PKW4Z-5 | 5 m (16.4 ft) | | | | |

6 Banner Engineering Corp. Limited Warranty

Banner Engineering Corp. warrants its products to be free from defects in material and workmanship for one year following the date of shipment. Banner Engineering Corp. will repair or replace, free of charge, any product of its manufacture which, at the time it is returned to the factory, is found to have been defective during the warranty period. This warranty does not cover damage or liability for misuse, abuse, or the improper application or installation of the Banner product.

THIS LIMITED WARRANTY IS EXCLUSIVE AND IN LIEU OF ALL OTHER WARRANTIES WHETHER EXPRESS OR IMPLIED (INCLUDING, WITHOUT LIMITATION, ANY WARRANTY OF MERCHANTABILITY OR FITNESS FOR A PARTICULAR PURPOSE), AND WHETHER ARISING UNDER COURSE OF PERFORMANCE, COURSE OF DEALING OR TRADE USAGE.

This Warranty is exclusive and limited to repair or, at the discretion of Banner Engineering Corp., replacement. **IN NO EVENT SHALL BANNER ENGINEERING CORP. BE LIABLE TO BUYER OR ANY OTHER PERSON OR ENTITY FOR ANY EXTRA COSTS, EXPENSES, LOSSES, LOSS OF PROFITS, OR ANY INCIDENTAL, CONSEQUENTIAL OR SPECIAL DAMAGES RESULTING FROM ANY PRODUCT DEFECT OR FROM THE USE OR INABILITY TO USE THE PRODUCT, WHETHER ARISING IN CONTRACT OR WARRANTY, STATUTE, TORT, STRICT LIABILITY, NEGLIGENCE, OR OTHERWISE.**

Banner Engineering Corp. reserves the right to change, modify or improve the design of the product without assuming any obligations or liabilities relating to any product previously manufactured by Banner Engineering Corp. Any misuse, abuse, or improper application or installation of this product or use of the product for personal protection applications when the product is identified as not intended for such purposes will void the product warranty. Any modifications to this product without prior express approval by Banner Engineering Corp will void the product warranties. All specifications published in this document are subject to change; Banner reserves the right to modify product specifications or update documentation at any time. Specifications and product information in English supersede that which is provided in any other language. For the most recent version of any documentation, refer to: www.bannerengineering.com.

For patent information, see www.bannerengineering.com/patents.