



FEATURES:

- Wide 2:1 Input Range
- 1600 VDC I/O Isolation
- Adjustable Output Voltage
- Soft Start
- Over Current & Over Voltage Protection
- Over Temperature Protection
- Efficiency up to 92%
- Temperature Range -40°C to +75°C
- Remote On/Off Function
- Continuous Short Circuit Protection
- No Minimum Load Required



Models Single output

Model	Input Voltage (V)	Output Voltage (V)	Output Current max (A)	Maximum Capacitive Load (uF)	Efficiency (%)
AM30E-1203SZ	9-18	3.3	8	20000	89
AM30E-1205SZ	9-18	5	6	14000	91
AM30E-1205.1SZ	9-18	5.1	6	14000	92
AM30E-1212SZ	9-18	12	2.5	2000	91
AM30E-1215SZ	9-18	15	2	2000	92
AM30E-2403SZ	18-36	3.3	8	20000	91
AM30E-2405SZ	18-36	5	6	14000	92
AM30E-2405.1SZ	18-36	5.1	6	14000	92
AM30E-2412SZ	18-36	12	2.5	2000	92
AM30E-2415SZ	18-36	15	2	2000	92
AM30E-4803SZ	36-75	3.3	8	20000	90
AM30E-4805SZ	36-75	5	6	14000	91
AM30E-4805.1SZ	36-75	5.1	6	14000	91
AM30E-4812SZ	36-75	12	2.5	2000	91
AM30E-4815SZ	36-75	15	2	2000	91

Add suffix “-K” for optional heat sink

Models Dual output

Model	Input Voltage (V)	Output Voltage (V)	Output Current max (mA)	Maximum Capacitive Load (uF)	Efficiency (%)
AM30E-1205DZ	9-18	±5	±3	±3000	89
AM30E-1212DZ	9-18	±12	±1.25	±1300	90
AM30E-1215DZ	9-18	±15	±1	±1300	91
AM30E-2405DZ	18-36	±5	±3	±3000	90
AM30E-2412DZ	18-36	±12	±1.25	±1300	91
AM30E-2415DZ	18-36	±15	±1	±1300	91
AM30E-4805DZ	36-75	±5	±3	±3000	90
AM30E-4812DZ	36-75	±12	±1.25	±1300	90
AM30E-4815DZ	36-75	±15	±1	±1300	90

Add suffix “-K” for optional heat sink

NOTE: All specifications in this datasheet are measured at an ambient temperature of 25°C, humidity<75%, nominal input voltage and at rated output load unless otherwise specified.

Input Specifications

Parameters	Nominal	Typical	Maximum	Units
Voltage range	12	9-18		VDC
	24	18-36		VDC
	48	36-75		VDC
Filter	π (Pi) Network			
Start up time		30		ms
Absolute Maximum Rating	12	-0.7 ~ 25		VDC
	24	-0.7 ~ 50		VDC
	48	-0.7 ~ 100		VDC

Input Specifications (continued)

Parameters	Nominal	Typical	Maximum	Units
Peak Input Voltage time			100	ms
On/Off control	ON: 3 ~12VDC or open circuit ; OFF - 0 ~ 1.2VDC or Short circuit between pin 2 and pin 3 (standby 5mA typ.)			
Under voltage lockout	12V ON/OFF	8.6 / 7.9		VDC
	24V ON/OFF	17.8 / 16		VDC
	48V ON/OFF	33.5 / 30.5		VDC
Input Reflected Ripple Current *		20		mA p-p

* The input reflected ripple current should be measured with a 4.7μH inductor and a 33μF input capacitor (ESR<1Ω at 100 KHz)

Isolation Specifications

Parameters	Conditions	Typical	Rated	Units
Tested I/O voltage	60 sec		1600	VDC
Case/Input tested voltage	60 sec	1600		VDC
Resistance		1000		MOhm
Capacitance		1500		pF

Output Specifications

Parameters	Conditions	Typical	Maximum	Units
Voltage accuracy		±1		%
Cross Regulation (Dual Output Models)	25% load on one output 100% load on second load	±5		%
Over voltage protection	Zener diode clamp			
Over current protection		150		%
Short Circuit protection	Continuous			
Short circuit restart	Auto-Recovery			
Thermal shutdown	On Case	115		°C
Line voltage regulation	HL-LL		±0.5	%
Load voltage regulation (Single)	0 – 100% load		±0.5	%
Load voltage regulation (Dual)	0 – 100% load		±1	%
Temperature coefficient		±0.02		%/°C
Ripple & Noise*	20MHz Bandwidth		100	mV p-p
Voltage adjustment range (single)		±10		%
Minimum Load Current		0		% of Max

* Measured with a 1μF CC.

General Specifications

Parameters	Conditions	Typical	Maximum	Units
Switching frequency	100% load	330		KHz
Operating temperature	Derating above 50	-40 to +75		°C
Storage temperature		-40 to +125		°C
Maximum case temperature			105	°C
Derating	+50 to +75°C, without heatsink	1.82		%/°C
Cooling	Free Air Convection(30-65 LFM)			
Humidity			95	% RH
Case material	Nickel coated Copper			
Weight		35		g
Dimensions (L x W x H)	2.00 x 1.00 x 0.40 inches	50.80 x 25.40 x 10.16 mm		
MTBF	>435,000 hrs (MIL-HDBK -217F, Ground Benign, t=+25°C)hours			
Maximum soldering temperature	1.5mm from case for 10 sec		260	°C
Transient recovery time	25% load step change	250		mS
Transient recovery deviation	25% load step change		±3	%

Safety Specifications

Parameters	
Agency Approvals	CE
Standards	EN55032 Class A with the recommended circuit
	IEC61000-4-2, Perf. Criteria A
	IEC61000-4-3, Perf. Criteria A
	IEC61000-4-4, Perf. Criteria A (external 220uF/100V cap required)
	IEC61000-4-5, Perf. Criteria A (external 220uF/100V cap required)
	IEC61000-4-6, Perf. Criteria A
	IEC61000-4-8, Perf. Criteria A
NOTE: also designed to meet IEC/EN 60950-1, 62368-1	

Pin Out Specifications

Pin	Single	Dual
1	+ V Input	+ V Input
2	- V Input	- V Input
3	On/Off Control	On/Off Control
4	+ V Output	+ V Output
5	-V Output	Common
6	Trim	- V Output

Dimensions

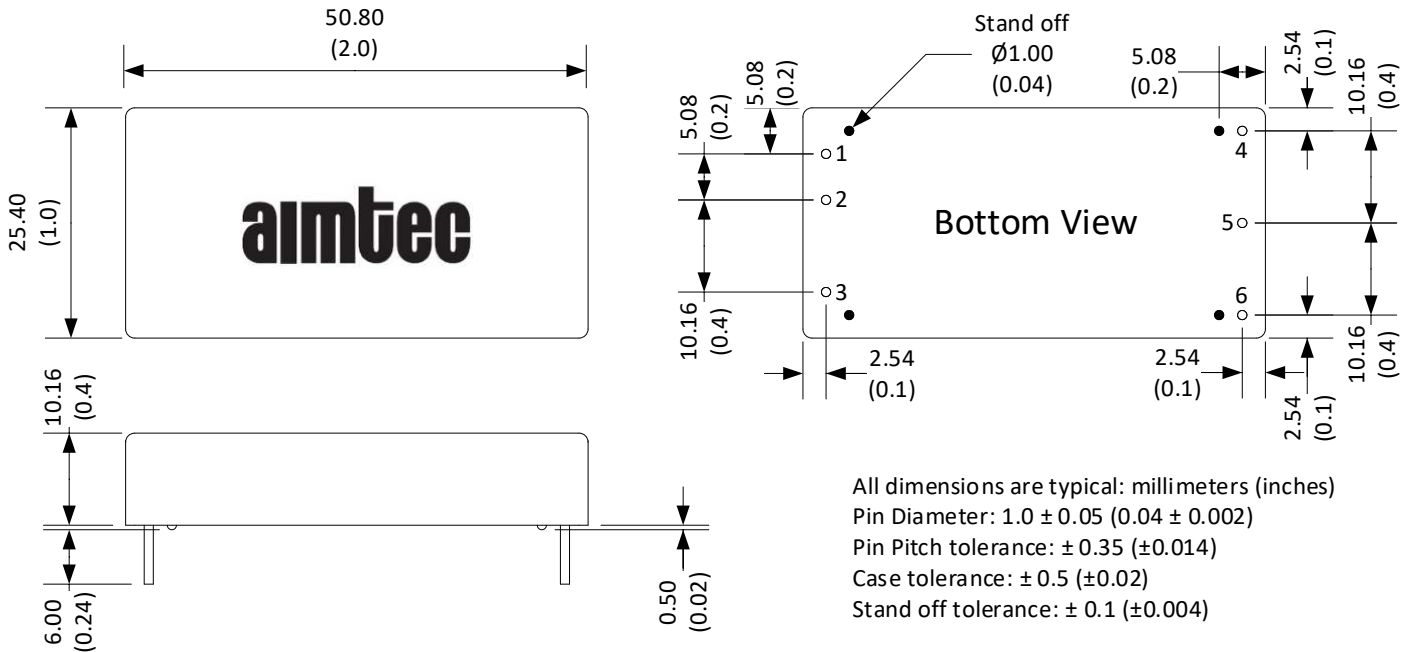

Dimensions with Optional Heat Sink

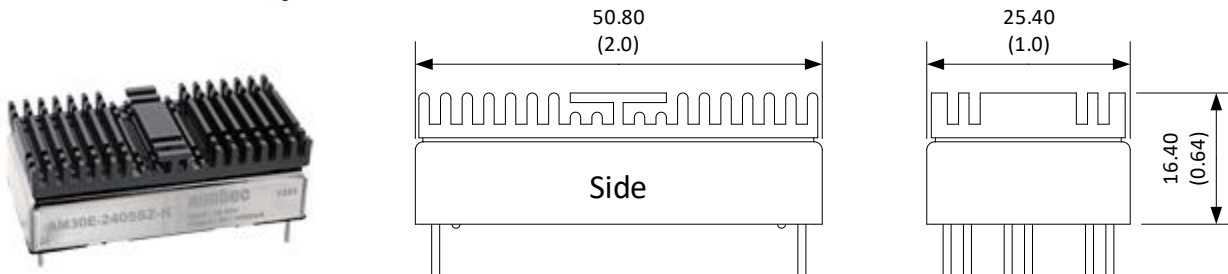

Notes: Add "-K" suffix for ordering, heat sink is affixed with thermally dissipative adhesive tape. See derating graph for temperature performance. Heat sink material is anodized (black) aluminum, adds weight 11.3g to total mass (46.3g).

Derating

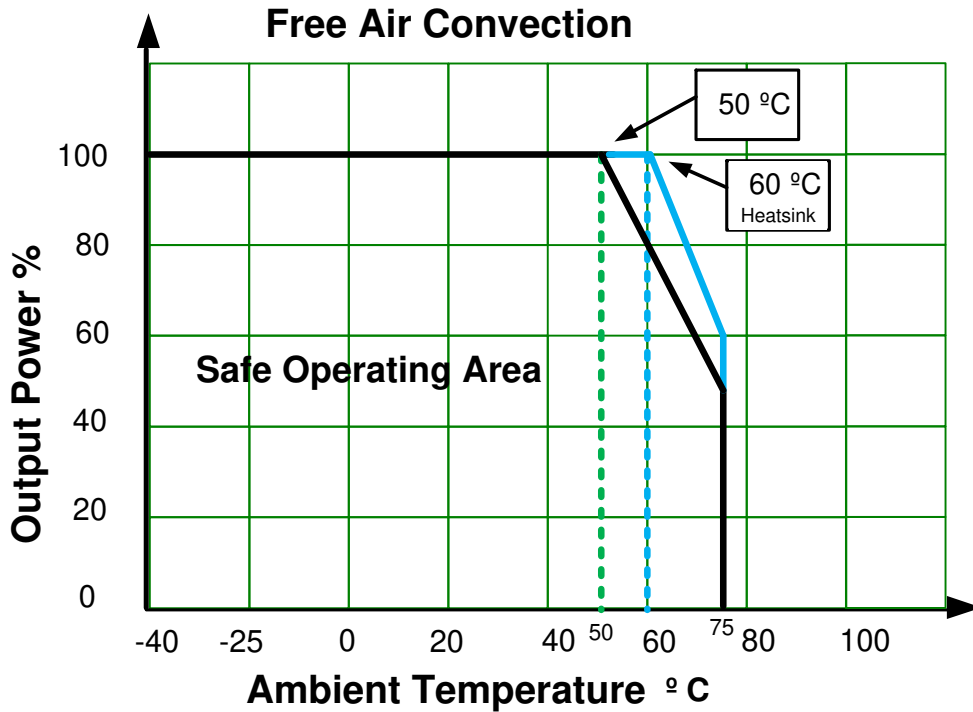

Extended temperature performance can be achieved with optional heat sink. (add suffix “-K” to part number)
Derating: 2.23 %/°C for converters with “-K” option

Trimming

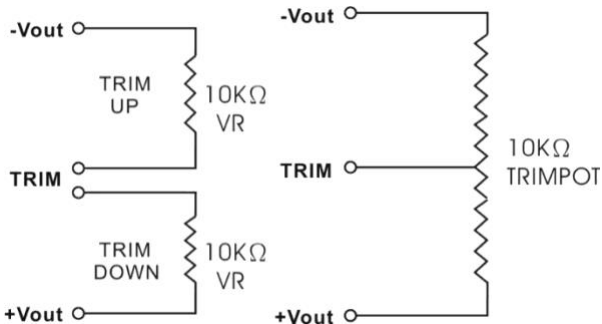

Control ON/OFF

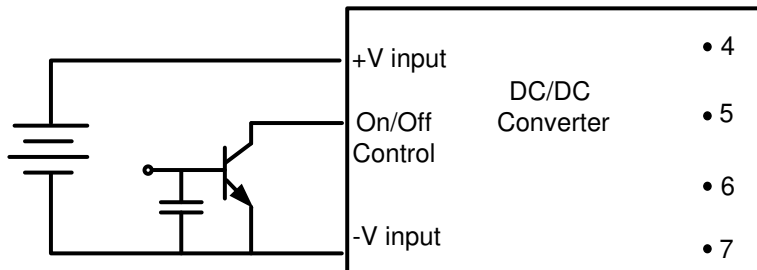

Positive logic turns on the module during high logic and off during low logic. Module can be controlled by an external switch between the On/Off CTRL terminal and -Vinput terminal. The switch can be either open collector or open drain

Recommended Circuits

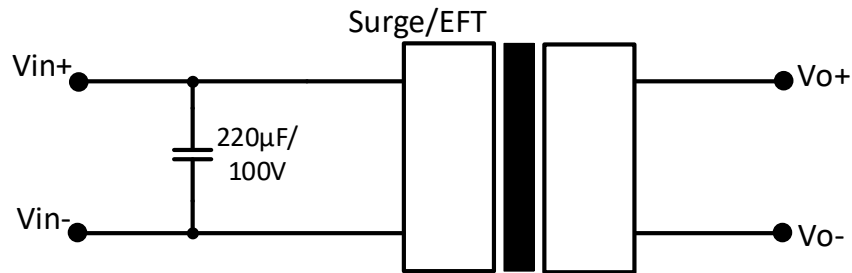
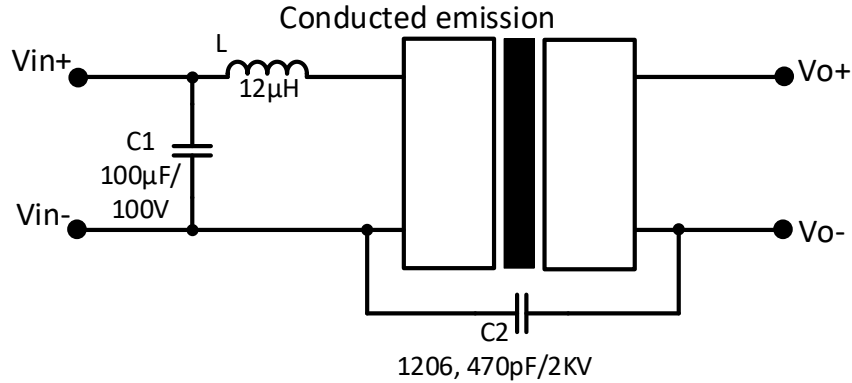

NOTE: 1. Datasheets are updated as needed and as such, specifications are subject to change without notice. Once printed or downloaded, datasheets are no longer controlled by Aimtec; refer to www.aimtec.com for the most current product specifications. 2. Product labels shown, including safety agency certifications on labels, may vary based on the date manufactured. 3. Mechanical drawings and specifications are for reference only. 4. All specifications are measured at an ambient temperature of 25°C, humidity<75%, nominal input voltage and at rated output load unless otherwise specified. 5. Aimtec may not have conducted destructive testing or chemical analysis on all internal components and chemicals at the time of publishing this document. CAS numbers and other limited information are considered proprietary and may not be available for release. 6. This product is not designed for use in critical life support systems, equipment used in hazardous environments, nuclear control systems or other such applications which necessitate specific safety and regulatory standards other the ones listed in this datasheet. 7. Warranty is in accordance with Aimtec's standard Terms of Sale available at www.aimtec.com.