

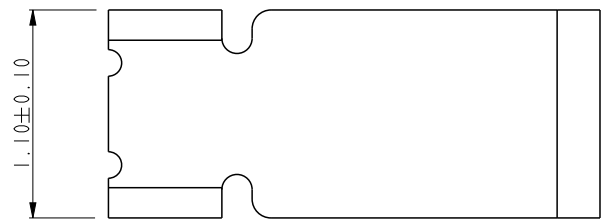

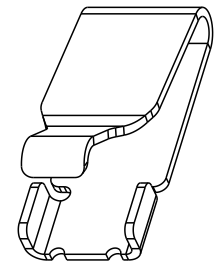

PRODUCT NO.	
FCI	10123973-004RLF
FCI	10123973-009RLF 

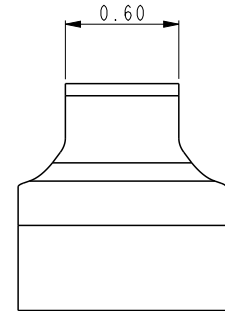
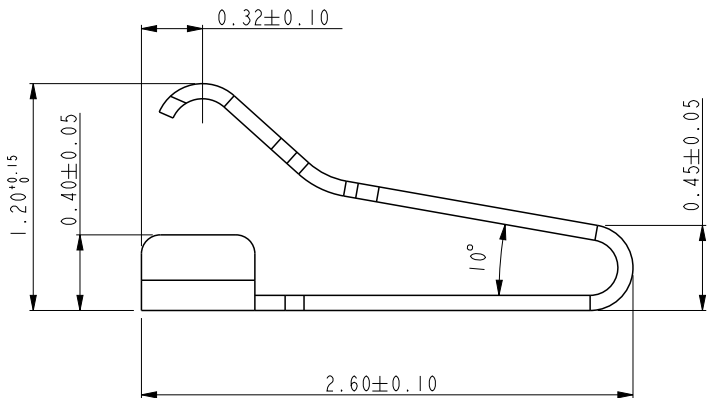

NOTES:
 1. MATERIAL: STAINLESS STEEL.
 2. CONTACT PLATING:
 CONTACT AREA: PLATING 8 MICROINCH Au OR 40 MICROINCH GXT OVER Ni UNDERPLATE, 
 SOLDER AREA : PLATING GOLD FLASH OVER Ni UNDERPLATE.
 3. PACKAGING: TAPE & REEL
 4. PART NUMBER DESCRIPTION:
 10123973-0 0 X X X
 LF: LEAD FREE
 R: TAPE & REEL
 CONTACT PLATING:
 4: 8 MICROINCH Au OVER Ni
 9: 40 MICROINCH GXT OVER Ni 

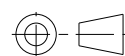
spec ref	*	dr	Andy Lu	2013/04/18	projection	mm	size	A4	scale	25 : 1	
tolerance std	TOLERANCES UNLESS OTHERWISE SPECIFIED	eng	Li-Qing Lei	2019/10/18			ecn no	ELX-N-35120-1			
ASME Y14.5		chr	-	-				rel level	Released		
surface		appr	Tim Yao	2019/10/18	product family	-	dwg no	10123973		rev	B
ASME Y14.5		linear			title	UNIVERSAL CONTACT					
		angular			cat. no.	Product - Customer Drw		sheet 1 of 2			

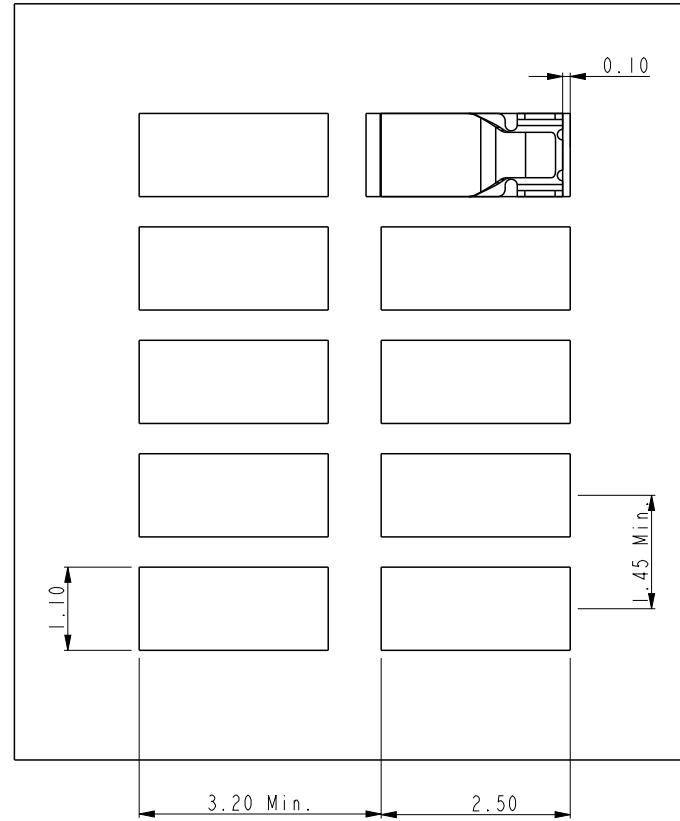

RECOMMENDED PCB DIMENSION & MIN PITCH
TOLERANCE: +/-0.05MM

spec ref *		dr Andy Lu		2013/04/18	projection 	mm 	size A4	scale 10 : 1
tolerance std		eng Li-Qing Lei		2019/10/18			ecn no ELX-N-35120-1	rel level Released
ASME Y14.5		chr -		-				
ASME Y14.5		appr Tim Yao		2019/10/18	product family -		rev B	
surface	linear	0.X	±0.3	Amphenol FCi	title UNIVERSAL CONTACT SMT SPRING		dwg no 10123973	
		0.XX	±0.15					
		0.XXX	±0.050					
ASME Y14.5	angular	0°	±2°	www.fci.com	cat. no.	Product - Customer Drw		sheet 2 of 2