

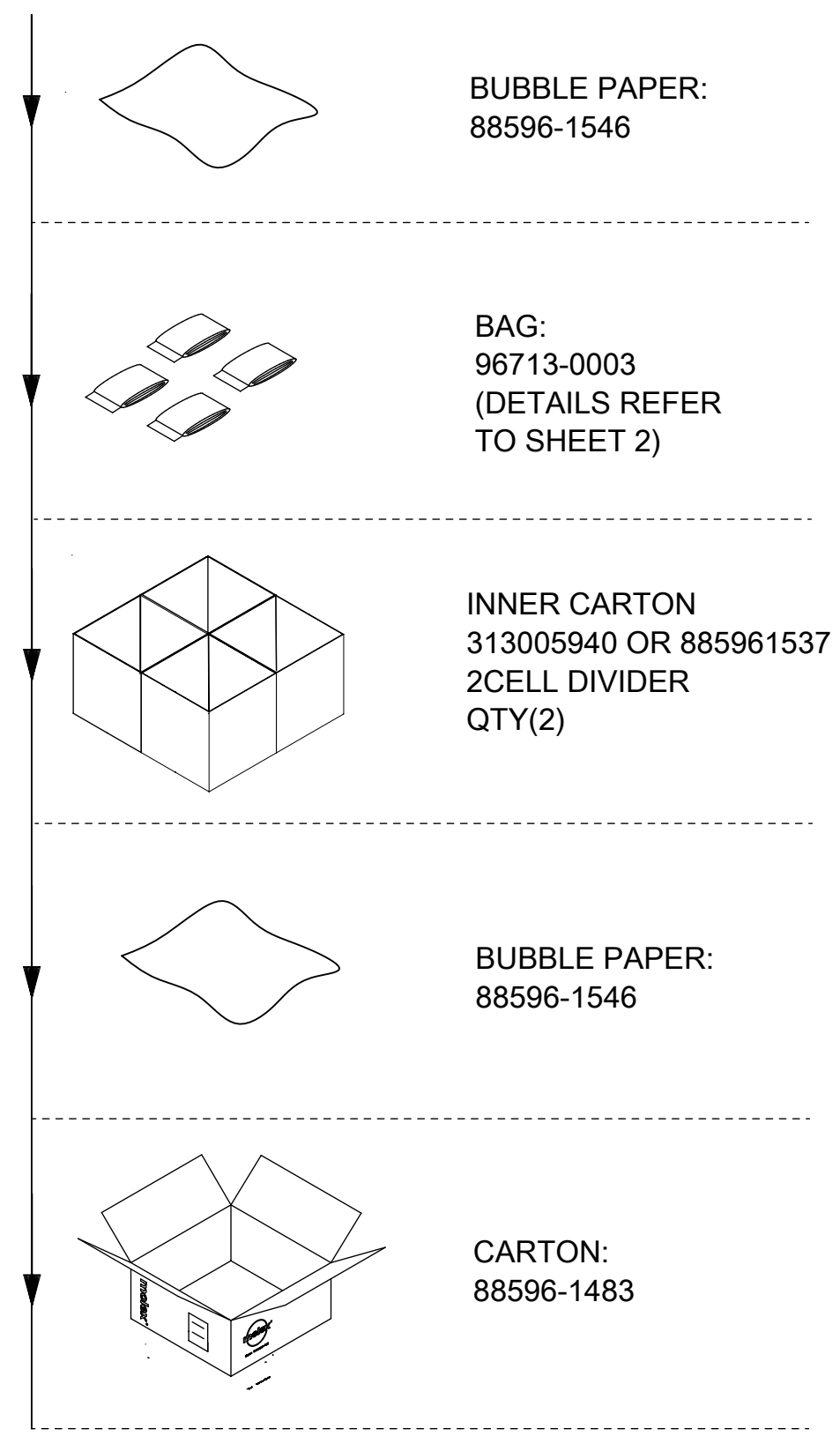





PART NUMBER	CKTS	QUANTITY PER BAG	BAGS PER CARTON	PARTS PER CARTON (SPQ)	MOISTURIZATION METHOD 	PANEL LOCK
215922-0201	2	3000	4	12000	NO MOISTURIZATION	WITHOUT
215922-0401	4	2600	4	10400		
215922-0601	6	2000	4	8000		
215922-0801	8	1700	4	6800		
215922-1001	10	1400	4	5600		
215922-1201	12	1000	4	4000		
215922-1401	14	800	4	3200		
215922-1601	16	800	4	3200		
215922-1801	18	600	4	2400		
215922-2001	20	600	4	2400		
215922-2201	22	600	4	2400		
215922-2401	24	450	4	1800		
215922-0200	2	2000	4	8000	SEE SHEET 2	WITH
215922-0400	4	1800	4	7200		
215922-0600	6	1600	4	6400		
215922-0800	8	1100	4	4400		
215922-1000	10	1000	4	4000		
215922-1200	12	900	4	3600		
215922-1400	14	800	4	3200		
215922-1600	16	700	4	2800		
215922-1800	18	600	4	2400		
215922-2000	20	600	4	2400		
215922-2200	22	400	4	1600		
215922-2400	24	350	4	1400		



TBD: NO PRODUCTION, TO BE ADDED AFTER BEING PRODUCED.

- NOTES:
-  MOISTURIZATION METHOD DESCRIPTIONS REFER TO SHEET 2.
 - STANDARD PACKAGE QUANTITY (SPQ) SEE ABOVE CHART.
 - PACKAGE WAY FOLLOW RIGHT ILLUSTRATION.
 - ALL PACKAGE MATERIAL AND PRODUCT COMPLIANT TO RoHS DIRECTIVE 2011/65/EU AND ELV DIRECTIVE 2000/53/EC.

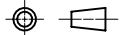
FUNCTIONAL SYMBOLS	THIS DRAWING CONTAINS INFORMATION THAT IS PROPRIETARY TO MOLEX ELECTRONIC TECHNOLOGIES, LLC AND SHOULD NOT BE USED WITHOUT WRITTEN PERMISSION		CURRENT REV DESC:					
	DIMENSION UNITS	SCALE						
 = 0	mm	1:1	GENERAL TOLERANCES (UNLESS SPECIFIED)		PACKING SPEC FOR MICRO-FIT PLUS WTW HSG			
 = 0								
 = 0								
ANGULAR TOL ± °								
DIVISIONAL SYMBOLS	4 PLACES	±	EC NO: 725570 DRWN: GLLI 2022/08/29 CHK'D: XQZHANG 2022/10/31 APPR: XQZHANG 2022/10/31		PRODUCT CUSTOMER DRAWING			
	3 PLACES	± 0.1						
	2 PLACES	± 0.3						
	1 PLACE	± 0.5						
	0 PLACES	±						
DRAFT WHERE APPLICABLE MUST REMAIN WITHIN DIMENSIONS		THIRD ANGLE PROJECTION	DRAWING	SERIES	DOCUMENT NUMBER	DOC TYPE	DOC PART	REVISION
			A3-SIZE	215922	2159220000-PK	PSD	000	B
					MATERIAL NUMBER	CUSTOMER	SHEET NUMBER	
							1 OF 2	

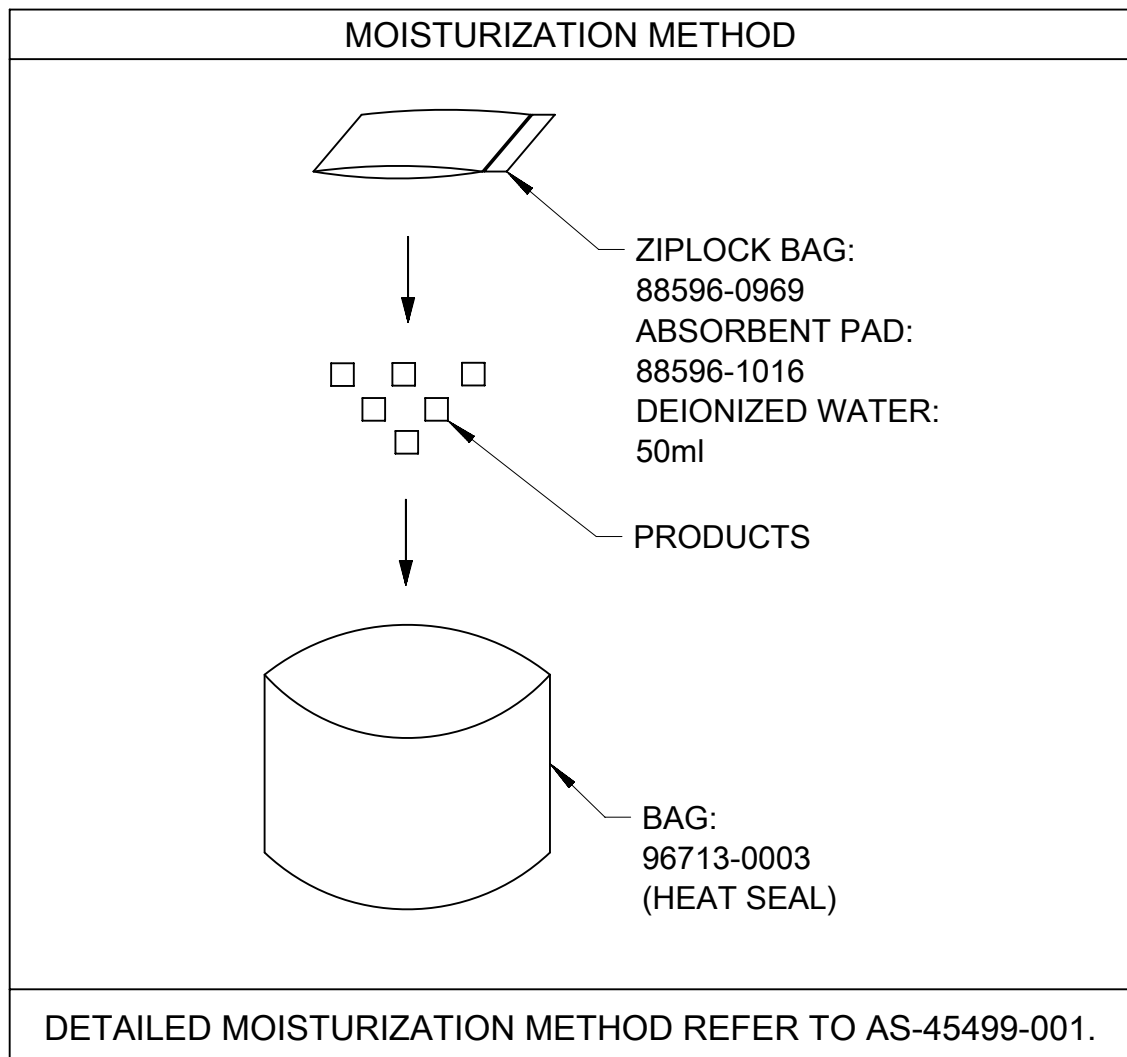

FUNCTIONAL SYMBOLS	THIS DRAWING CONTAINS INFORMATION THAT IS PROPRIETARY TO MOLEX ELECTRONIC TECHNOLOGIES, LLC AND SHOULD NOT BE USED WITHOUT WRITTEN PERMISSION		
$\nabla_A = 0$	DIMENSION UNITS	SCALE	CURRENT REV DESC: EC NO: 725570 DRWN: GLLI 2022/08/29 CHK'D: XQZHANG 2022/10/31 APPR: XQZHANG 2022/10/31 INITIAL REVISION: DRWN: GLLI 2021/10/28 APPR: XQZHANG 2021/11/15
$\nabla_F = 0$	mm	1:1	
$\nabla_P = 0$	GENERAL TOLERANCES (UNLESS SPECIFIED)		
	ANGULAR TOL ± °		
DIVISIONAL SYMBOLS			DOCUMENT NUMBER <div style="font-size: 14px; font-weight: bold; text-align: center;">2159220000-PK</div> DOC TYPE PSD
	4 PLACES ±		
	3 PLACES ± 0.1		
	2 PLACES ± 0.3		
	1 PLACE ± 0.5		
	0 PLACES ±		DOC PART 000
DRAFT WHERE APPLICABLE MUST REMAIN WITHIN DIMENSIONS		THIRD ANGLE PROJECTION	DRAWING A3-SIZE
		SERIES 215922	REVISION B
		MATERIAL NUMBER	CUSTOMER
		SHEET NUMBER 2 OF 2	

FREE HANGING PLUG PARTS

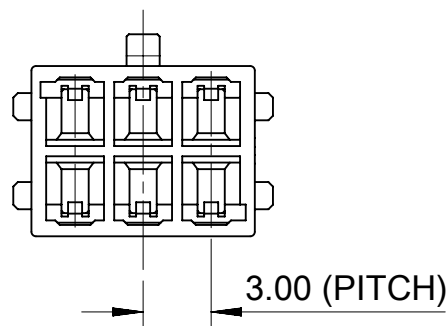
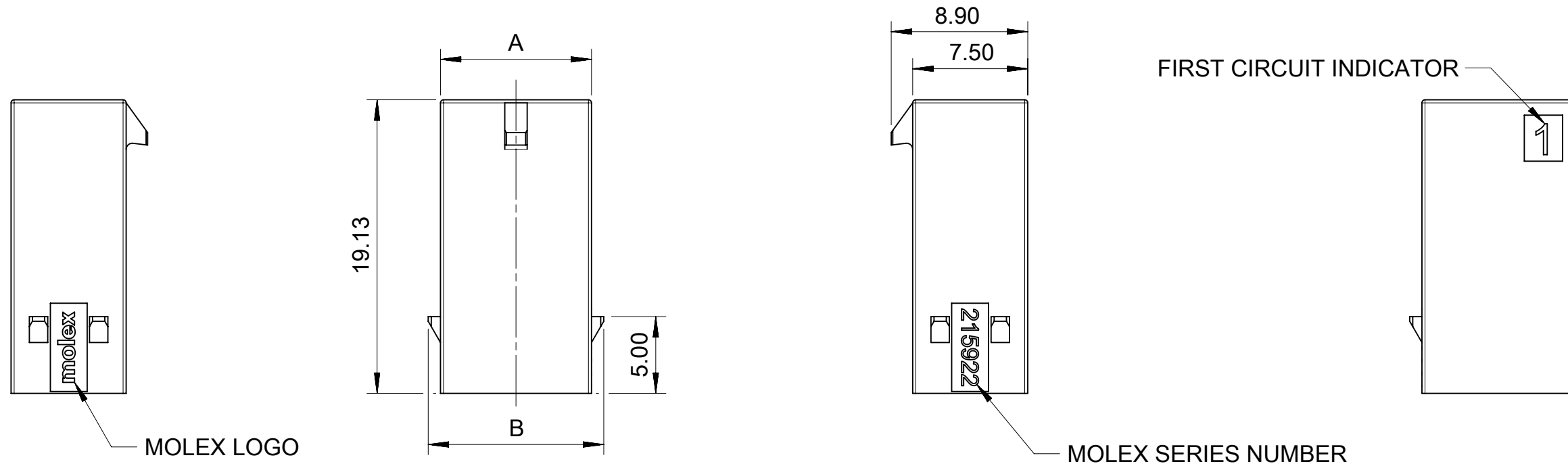

PART No	DIM'A'	DIM'B'	CKT SIZE
215922-0201	3.85	5.45	2
215922-0401	6.85	8.45	4
215922-0601	9.85	11.45	6
215922-0801	12.85	14.45	8
215922-1001	15.85	17.45	10
215922-1201	18.85	20.45	12
215922-1401	21.85	23.45	14
215922-1601	24.85	26.45	16
215922-1801	27.85	29.45	18
215922-2001	30.85	32.45	20
215922-2201	33.85	35.45	22
215922-2401	36.85	38.45	24

- NOTES:
1. MATERIAL: PA66, 94V-0, BLACK.
 2. PRODUCT SPECIFICATION: 2159530000-PS.
 3. PACKAGE SPECIFICATION: 2159220000-PK.
 4. TO USE WITH TERMINAL OF 2015953-****.
 5. TO USE WITH TPA OF 206462-****.
 6. TO MATE WITH RECEPTACLE OF 206461-****.
 7. PARTS CONFORM TO CLASS 'B' REQUIREMENTS OF COSMETIC SPECIFICATION PS-45499-002.

FUNCTIONAL SYMBOLS	THIS DRAWING CONTAINS INFORMATION THAT IS PROPRIETARY TO MOLEX ELECTRONIC TECHNOLOGIES, LLC AND SHOULD NOT BE USED WITHOUT WRITTEN PERMISSION		CURRENT REV DESC:									
	DIMENSION UNITS	SCALE							PLUG HOUSING OF MICRO-FIT PLUS WTW DR POWER CONNECTOR			
DIVISIONAL SYMBOLS	$\nabla_A = 0$	mm	1:1	EC NO: 712744 DRWN: GLLI 2022/07/01 CHK'D: XQZHANG 2022/07/05 APPR: XQZHANG 2022/07/05		PRODUCT CUSTOMER DRAWING						
	GENERAL TOLERANCES (UNLESS SPECIFIED)					DOCUMENT NUMBER		DOC TYPE	DOC PART	REVISION		
	ANGULAR TOL \pm °					INITIAL REVISION:		2159220000-SD		PSD	000	A1
	4 PLACES \pm					DRWN: GLLI 2021/01/29						
3 PLACES \pm			APPR: XQZHANG 2021/11/15									
2 PLACES ± 0.2												
1 PLACE ± 0.3												
0 PLACES \pm												
DRAFT WHERE APPLICABLE MUST REMAIN WITHIN DIMENSIONS			THIRD ANGLE PROJECTION	DRAWING	SERIES	MATERIAL NUMBER	CUSTOMER	SHEET NUMBER				
				A3-SIZE	215922		GENERAL MARKET	1 OF 6				

FREE HANGING PLUG PARTS

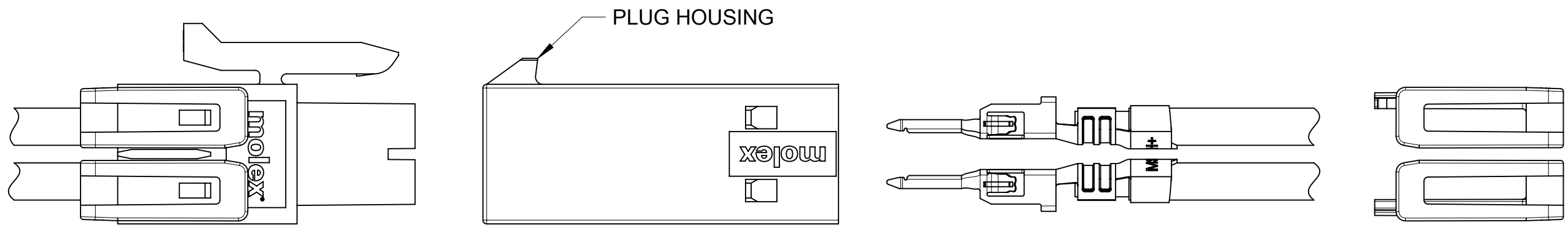
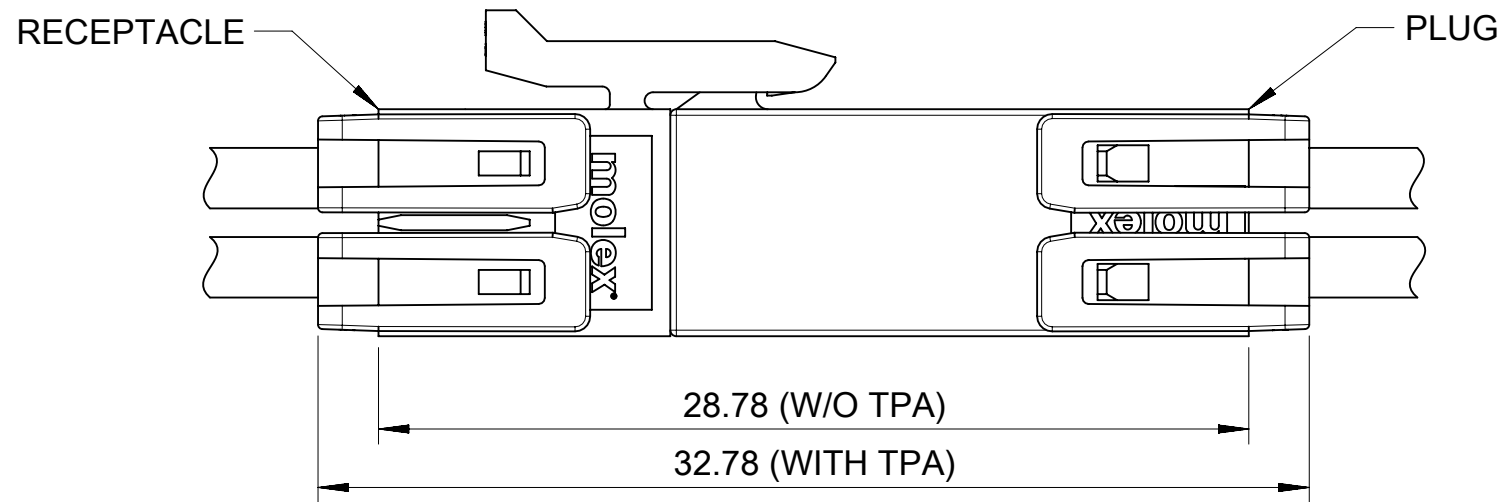

FUNCTIONAL SYMBOLS	THIS DRAWING CONTAINS INFORMATION THAT IS PROPRIETARY TO MOLEX ELECTRONIC TECHNOLOGIES, LLC AND SHOULD NOT BE USED WITHOUT WRITTEN PERMISSION		CURRENT REV DESC:		molex				
	△/A = 0	mm							SCALE 1:1
DIVISIONAL SYMBOLS	GENERAL TOLERANCES (UNLESS SPECIFIED)				EC NO: 712744				
	ANGULAR TOL ± °				DRWN: GLLI 2022/07/01				
	4 PLACES ±				CHK'D: XQZHANG 2022/07/05				
	3 PLACES ±				APPR: XQZHANG 2022/07/05				
	2 PLACES ± 0.2				INITIAL REVISION:				
1 PLACE ± 0.3				DRWN: GLLI 2021/01/29					
0 PLACES ±				APPR: XQZHANG 2021/11/15					
DRAFT WHERE APPLICABLE MUST REMAIN WITHIN DIMENSIONS				THIRD ANGLE PROJECTION	DRAWING	SERIES	MATERIAL NUMBER	CUSTOMER	SHEET NUMBER
					A3-SIZE	215922	2159220000-SD	GENERAL MARKET	2 OF 6

FREE HANGING PLUG PARTS

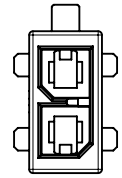

2 CKT

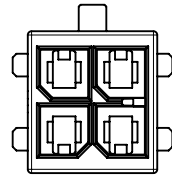

4 CKT

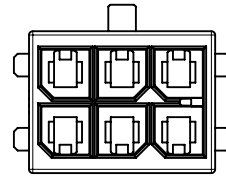

6 CKT

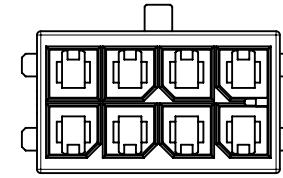

8 CKT

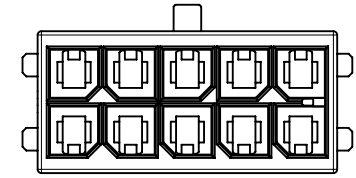

10 CKT

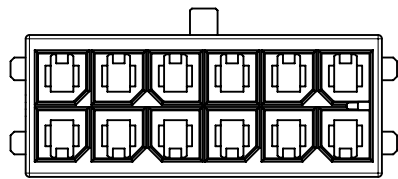

12 CKT

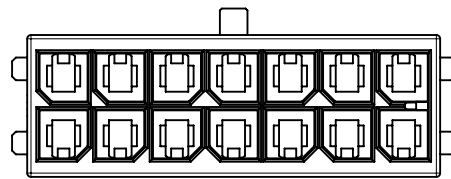

14 CKT

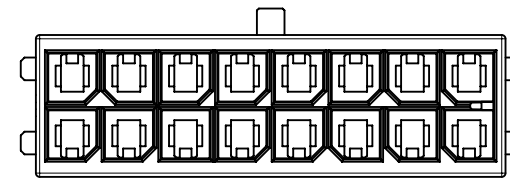

16 CKT

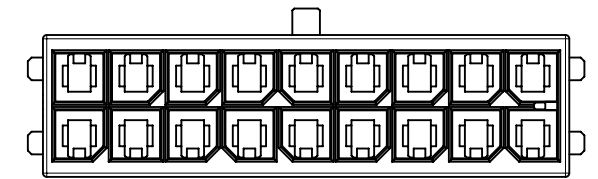

18 CKT

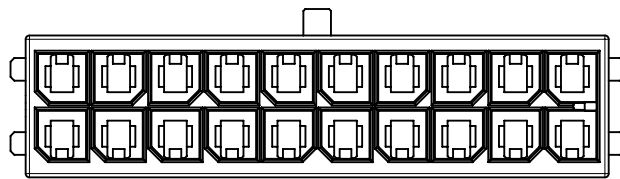

20 CKT

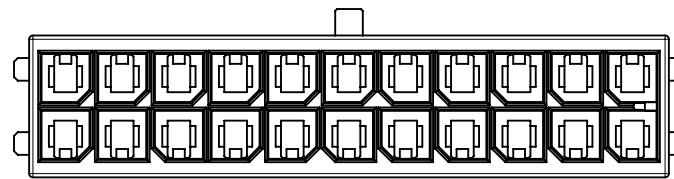

22 CKT

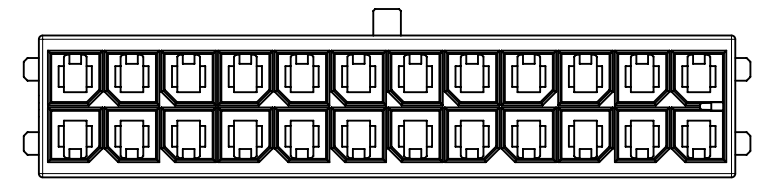

24 CKT

FUNCTIONAL SYMBOLS	THIS DRAWING CONTAINS INFORMATION THAT IS PROPRIETARY TO MOLEX ELECTRONIC TECHNOLOGIES, LLC AND SHOULD NOT BE USED WITHOUT WRITTEN PERMISSION		CURRENT REV DESC:					
	$\nabla_A = 0$ $\nabla_E = 0$ $\nabla_V = 0$	DIMENSION UNITS mm						
DIVISIONAL SYMBOLS	4 PLACES	±	EC NO: 712744		PRODUCT CUSTOMER DRAWING			
	3 PLACES	±	DRWN: GLLI 2022/07/01					
	2 PLACES	± 0.2	CHK'D: XQZHANG 2022/07/05					
	1 PLACE	± 0.3	APPR: XQZHANG 2022/07/05					
	0 PLACES	±	INITIAL REVISION:		DOCUMENT NUMBER	DOC TYPE	DOC PART	REVISION
DRAFT WHERE APPLICABLE MUST REMAIN WITHIN DIMENSIONS		THIRD ANGLE PROJECTION		DRAWING	SERIES	MATERIAL NUMBER	CUSTOMER	SHEET NUMBER
				A3-SIZE	215922	2159220000-SD	GENERAL MARKET	3 OF 6

PANEL MOUNT PLUG PARTS

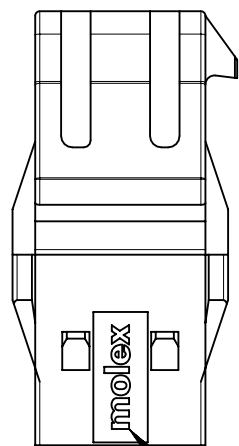

MOLEX LOGO

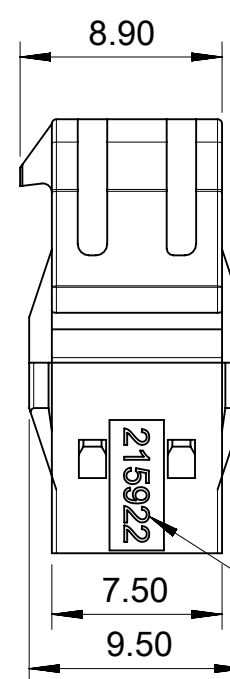
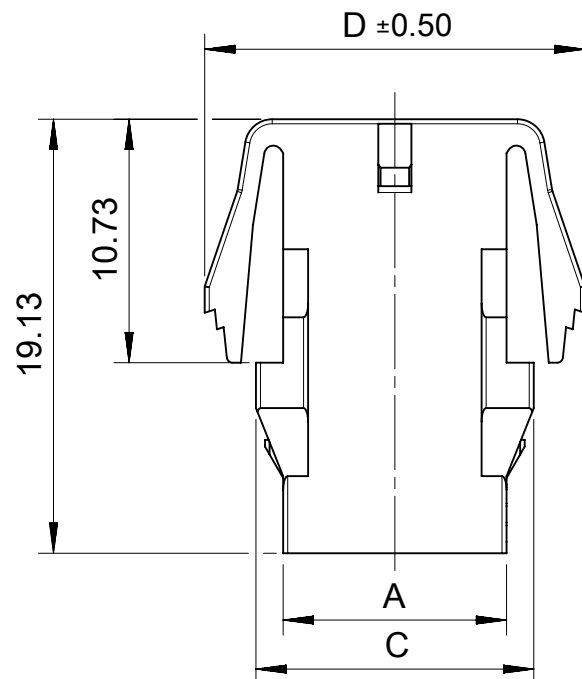

FIRST CIRCUIT INDICATOR

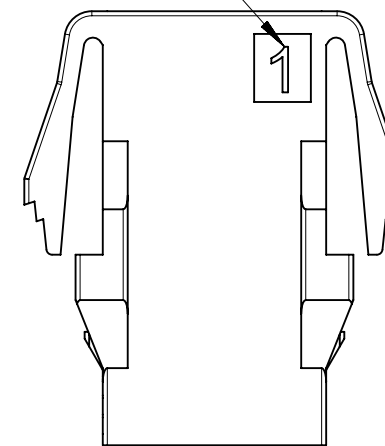

MOLEX SERIES NUMBER

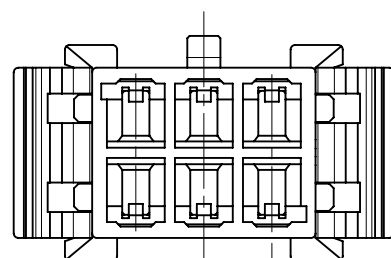

3.00 (PITCH)

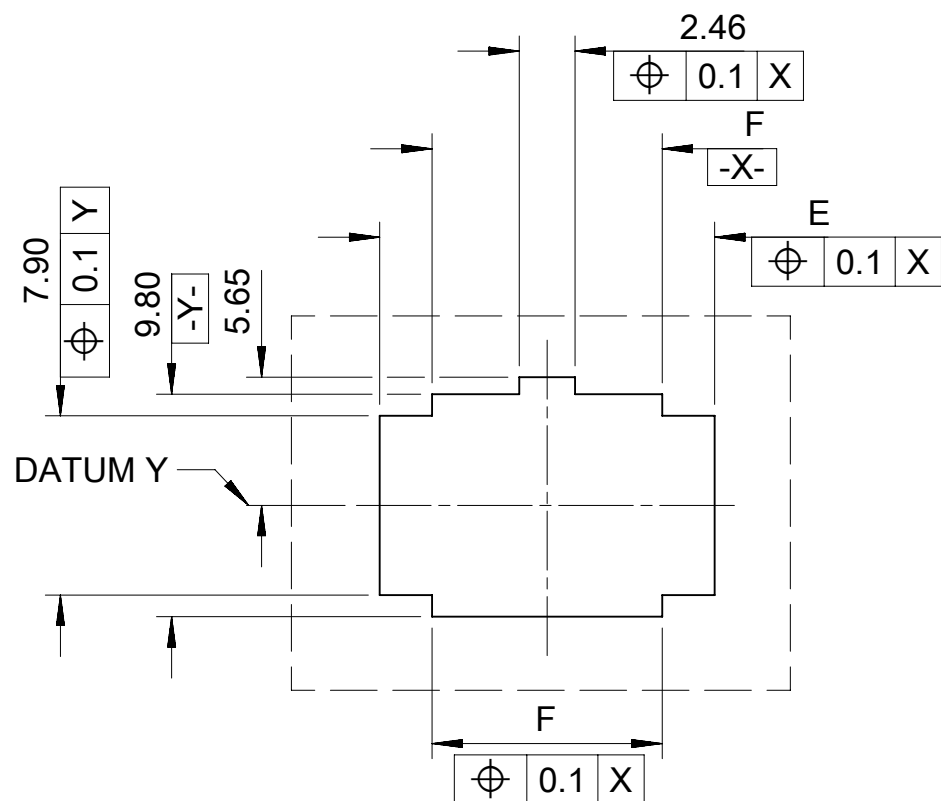

PART No	DIM 'A'	DIM 'C'	DIM 'D'	DIM 'E'	DIM 'F'	CKT SIZE
215922-0200	3.85	6.25	10.77	8.77	4.15	2
215922-0400	6.85	9.25	13.77	11.77	7.15	4
215922-0600	9.85	12.25	16.77	14.77	10.15	6
215922-0800	12.85	15.25	19.77	17.77	13.15	8
215922-1000	15.85	18.25	22.77	20.77	16.15	10
215922-1200	18.85	21.25	25.77	23.77	19.15	12
215922-1400	21.85	24.25	28.77	26.77	22.15	14
215922-1600	24.85	27.25	31.77	29.77	25.15	16
215922-1800	27.85	30.25	34.77	32.77	28.15	18
215922-2000	30.85	33.25	37.77	35.77	31.15	20
215922-2200	33.85	36.25	40.77	38.77	34.15	22
215922-2400	36.85	39.25	43.77	41.77	37.15	24

RECOMMENDED PANEL CUT OUT
(TOLERRANCE +/-0.05 THICKNESS=1.2~2.2MM)

FUNCTIONAL SYMBOLS	THIS DRAWING CONTAINS INFORMATION THAT IS PROPRIETARY TO MOLEX ELECTRONIC TECHNOLOGIES, LLC AND SHOULD NOT BE USED WITHOUT WRITTEN PERMISSION	CURRENT REV DESC:		molex				
	GENERAL TOLERANCES (UNLESS SPECIFIED)	EC NO: 712744						PLUG HOUSING OF MICRO-FIT PLUS WTW DR POWER CONNECTOR
FUNCTIONAL SYMBOLS	mm	1:1	DRWN: GLLI		2022/07/01		PRODUCT CUSTOMER DRAWING	
FUNCTIONAL SYMBOLS	ANGULAR TOL ± °		CHK'D: XQZHANG		2022/07/05		DOCUMENT NUMBER	
DIVISIONAL SYMBOLS	4 PLACES ±		APPR: XQZHANG		2022/07/05		DOC TYPE	
DIVISIONAL SYMBOLS	3 PLACES ±		INITIAL REVISION:		2021/01/29		DOC PART	
DIVISIONAL SYMBOLS	2 PLACES ± 0.2		DRWN: GLLI		2021/11/15		REVISION	
DIVISIONAL SYMBOLS	1 PLACE ± 0.3		APPR: XQZHANG		2021/11/15		2159220000-SD	
DIVISIONAL SYMBOLS	0 PLACES ±		THIRD ANGLE PROJECTION		DRAWING		SERIES	
DIVISIONAL SYMBOLS	DRAFT WHERE APPLICABLE MUST REMAIN WITHIN DIMENSIONS		A3-SIZE		215922		MATERIAL NUMBER	
DIVISIONAL SYMBOLS	CUSTOMER		GENERAL MARKET		SHEET NUMBER		4 OF 6	

PANEL MOUNT PLUG PARTS

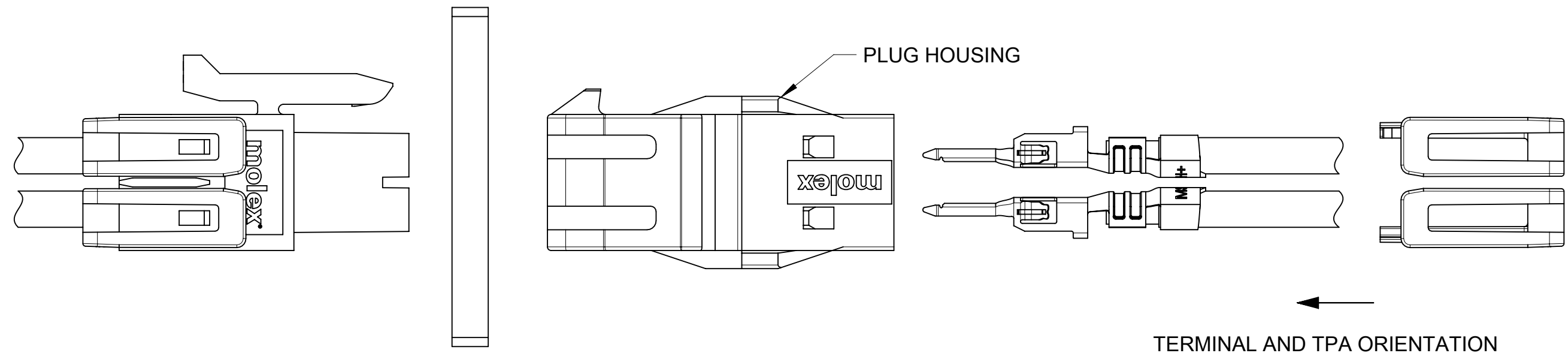
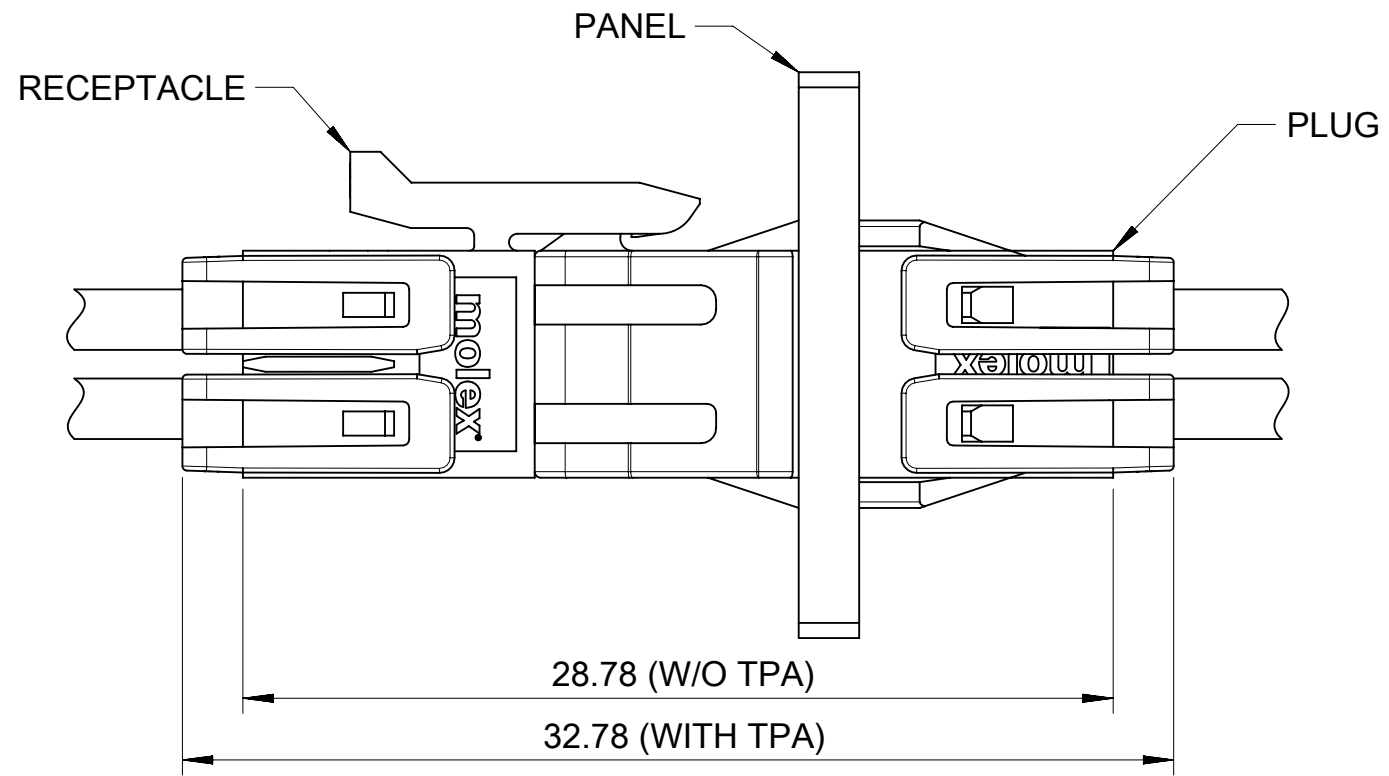

FUNCTIONAL SYMBOLS	THIS DRAWING CONTAINS INFORMATION THAT IS PROPRIETARY TO MOLEX ELECTRONIC TECHNOLOGIES, LLC AND SHOULD NOT BE USED WITHOUT WRITTEN PERMISSION		CURRENT REV DESC:		molex				
	▽A = 0	mm							SCALE
DIVISIONAL SYMBOLS	GENERAL TOLERANCES (UNLESS SPECIFIED)				PLUG HOUSING OF MICRO-FIT PLUS WTW DR POWER CONNECTOR				
	▽E = 0	ANGULAR TOL ± °			PRODUCT CUSTOMER DRAWING				
DIVISIONAL SYMBOLS	4 PLACES	±	EC NO: 712744		DOCUMENT NUMBER				
	3 PLACES	±	DRWN: GLLI		2159220000-SD				
	2 PLACES	± 0.2	CHK'D: XQZHANG		DOC TYPE				
	1 PLACE	± 0.3	APPR: XQZHANG		PSD				
	0 PLACES	±	INITIAL REVISION:		DOC PART				
DRAFT WHERE APPLICABLE MUST REMAIN WITHIN DIMENSIONS		THIRD ANGLE PROJECTION		DRAWING		SERIES		REVISION	
		A3-SIZE		215922		GENERAL MARKET		5 OF 6	

PANEL MOUNT PLUG PARTS

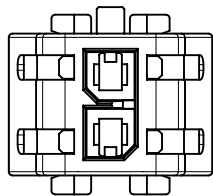

2 CKT

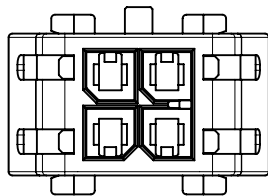

4 CKT

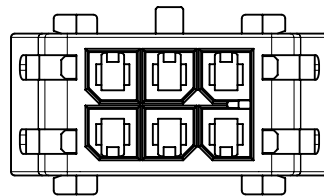

6 CKT

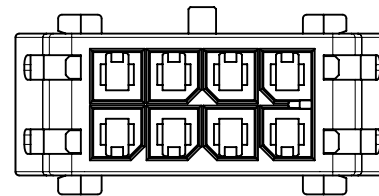

8 CKT

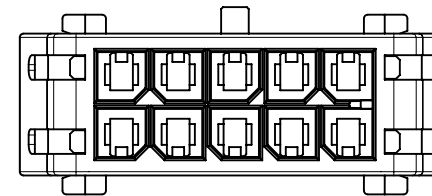

10 CKT

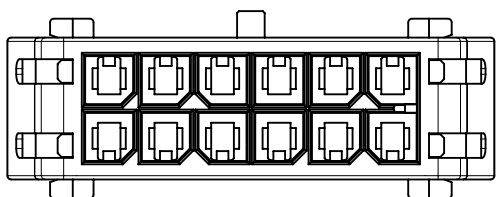

12 CKT

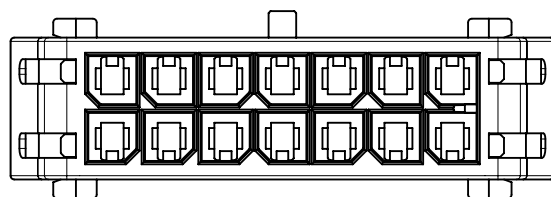

14 CKT

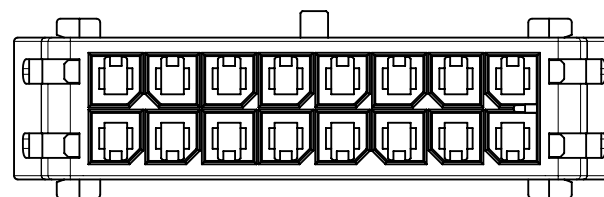

16 CKT

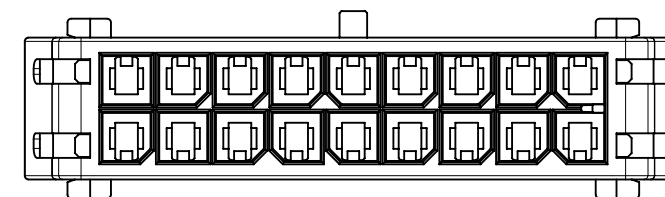

18 CKT

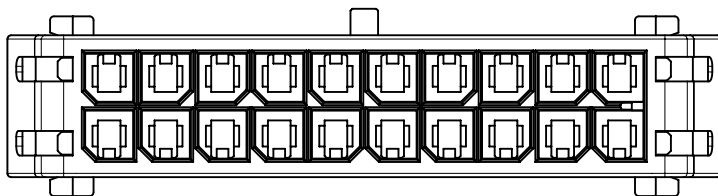

20 CKT

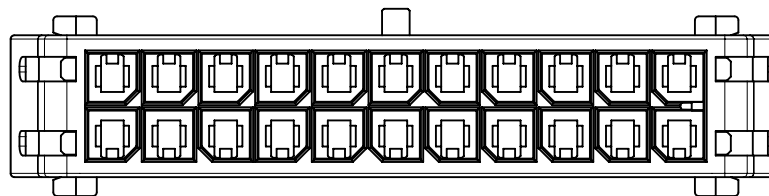

22 CKT

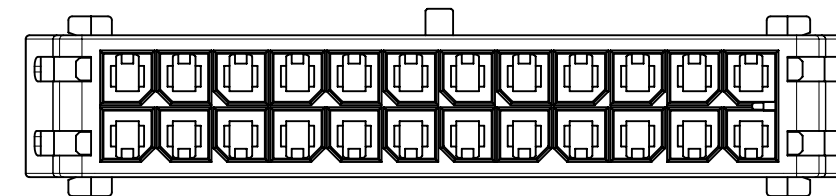

24 CKT

FUNCTIONAL SYMBOLS	THIS DRAWING CONTAINS INFORMATION THAT IS PROPRIETARY TO MOLEX ELECTRONIC TECHNOLOGIES, LLC AND SHOULD NOT BE USED WITHOUT WRITTEN PERMISSION		CURRENT REV DESC:		molex				
	4 PLACES	±							PLUG HOUSING OF MICRO-FIT PLUS WTW DR POWER CONNECTOR
GENERAL TOLERANCES (UNLESS SPECIFIED)	ANGULAR TOL ± °		EC NO: 712744		PRODUCT CUSTOMER DRAWING				
3 PLACES ±	±		DRWN: GLLI 2022/07/01		DOCUMENT NUMBER				
2 PLACES ± 0.2	± 0.2		CHK'D: XQZHANG 2022/07/05		2159220000-SD		DOC TYPE	DOC PART	REVISION
1 PLACE ± 0.3	± 0.3		APPR: XQZHANG 2022/07/05		2021/01/29		PSD	000	A1
0 PLACES ±	±		INITIAL REVISION:		2021/11/15		SHEET NUMBER		
DRAFT WHERE APPLICABLE MUST REMAIN WITHIN DIMENSIONS	THIRD ANGLE PROJECTION	DRAWING	SERIES	MATERIAL NUMBER	CUSTOMER	SHEET NUMBER			
		A3-SIZE	215922	GENERAL MARKET	6 OF 6				