

## DM74S04 Hex Inverting Gates

### General Description

This device contains six independent gates each of which performs the logic INVERT function.

### Connection Diagram

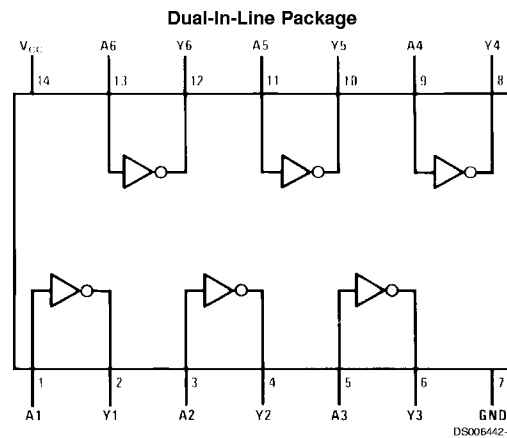

Order Number DM54S04J, DM54S04W, DM74S04M or DM74S04N  
See Package Number J14A, M14A, N14A or W14B

### Function Table

$$Y = \overline{A}$$

Input	Output
A	Y
L	H
H	L

H = High Logic Level  
L = Low Logic Level

## Absolute Maximum Ratings (Note 1)

Supply Voltage	7V	DM54S	-55°C to +125°C
Input Voltage	5.5V	DM74S	0°C to +70°C
Operating Free Air Temperature Range		Storage Temperature Range	-65°C to +150°C

## Recommended Operating Conditions

Symbol	Parameter	DM54S04			DM74S04			Units
		Min	Nom	Max	Min	Nom	Max	
V <sub>CC</sub>	Supply Voltage	4.5	5	5.5	4.75	5	5.25	V
V <sub>IH</sub>	High Level Input Voltage	2			2			V
V <sub>IL</sub>	Low Level Input Voltage			0.8			0.8	V
I <sub>OH</sub>	High Level Output Current			-1			-1	mA
I <sub>OL</sub>	Low Level Output Current			20			20	mA
T <sub>A</sub>	Free Air Operating Temperature	-55		125	0		70	°C

**Note 1:** The "Absolute Maximum Ratings" are those values beyond which the safety of the device cannot be guaranteed. The device should not be operated at these limits. The parametric values defined in the "Electrical Characteristics" table are not guaranteed at the absolute maximum ratings. The "Recommended Operating Conditions" table will define the conditions for actual device operation.

## Electrical Characteristics

over recommended operating free air temperature range (unless otherwise noted)

Symbol	Parameter	Conditions	Min	Typ (Note 2)	Max	Units
V <sub>I</sub>	Input Clamp Voltage	V <sub>CC</sub> = Min, I <sub>I</sub> = -18 mA			-1.2	V
V <sub>OH</sub>	High Level Output Voltage	V <sub>CC</sub> = Min, I <sub>OH</sub> = Max V <sub>IL</sub> = Max	DM54 2.5	3.4		V
V <sub>OL</sub>	Low Level Output Voltage	V <sub>CC</sub> = Min, I <sub>OL</sub> = Max V <sub>IH</sub> = Min			0.5	V
I <sub>I</sub>	Input Current @ Max Input Voltage	V <sub>CC</sub> = Max, V <sub>I</sub> = 5.5V			1	mA
I <sub>IH</sub>	High Level Input Current	V <sub>CC</sub> = Max, V <sub>I</sub> = 2.7V			50	μA
I <sub>IL</sub>	Low Level Input Current	V <sub>CC</sub> = Max, V <sub>I</sub> = 0.5V			-2	mA
I <sub>OS</sub>	Short Circuit Output Current	V <sub>CC</sub> = Max (Note 3)	DM54 -40		-100	mA
I <sub>COH</sub>	Supply Current with Outputs High	V <sub>CC</sub> = Max		15	24	mA
I <sub>COL</sub>	Supply Current with Outputs Low	V <sub>CC</sub> = Max		30	54	mA

## Switching Characteristics

at V<sub>CC</sub> = 5V and T<sub>A</sub> = 25°C (See Section 1 for Test Waveforms and Output Load)

Symbol	Parameter	R <sub>L</sub> = 280Ω				Units
		C <sub>L</sub> = 15 pF		C <sub>L</sub> = 50 pF		
		Min	Max	Min	Max	
t <sub>PLH</sub>	Propagation Delay Time Low to High Level Output	2	4.5	2	7	ns
t <sub>PHL</sub>	Propagation Delay Time High to Low Level Output	2	5	2	8	ns

**Note 2:** All typicals are at V<sub>CC</sub> = 5V, T<sub>A</sub> = 25°C.

**Note 3:** Not more than one output should be shorted at a time, and the duration should not exceed one second.

**Physical Dimensions** inches (millimeters) unless otherwise noted

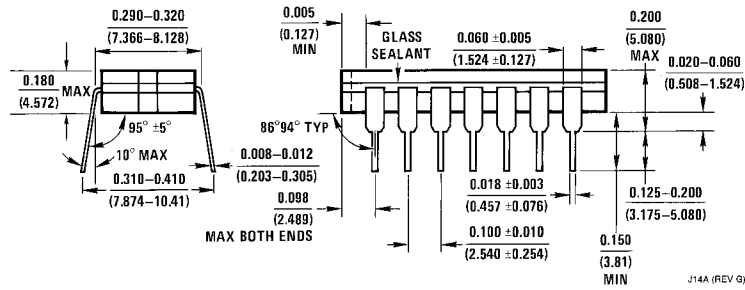
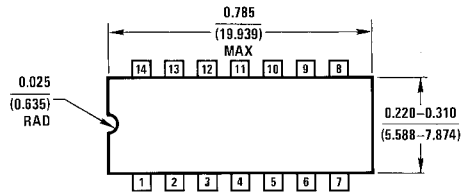

**14-Lead Ceramic Dual-In-Line Package (J)**  
**Order Number DM54S04J**  
**Package Number J14A**

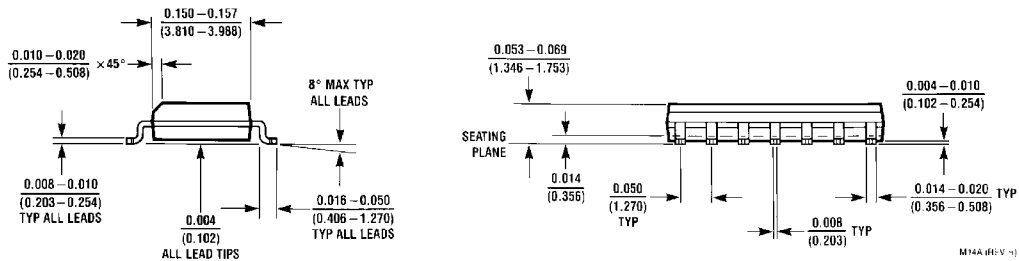
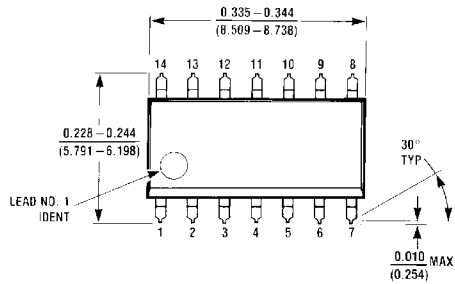

**14-Lead Small Outline Molded Package (M)**  
**Order Number DM74S04M**  
**Package Number M14A**

**Physical Dimensions** inches (millimeters) unless otherwise noted (Continued)

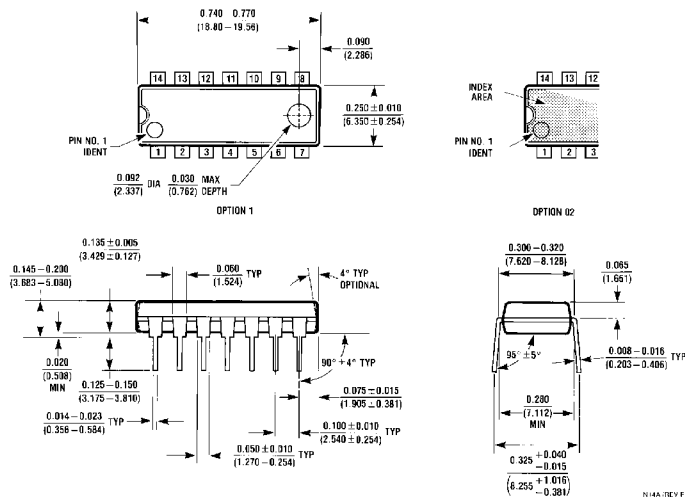

**14-Lead Molded Dual-In-Line Package (N)**  
**Order Number DM74S04N**  
**Package Number N14A**

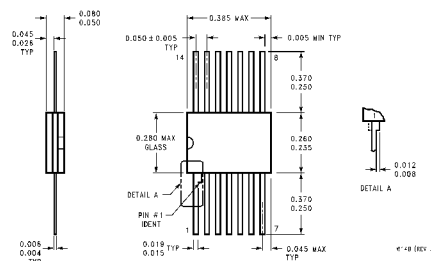

**14-Lead Ceramic Flat Package (W)**  
**Order Number DM54S04W**  
**Package Number W14B**

**LIFE SUPPORT POLICY**

FAIRCHILD'S PRODUCTS ARE NOT AUTHORIZED FOR USE AS CRITICAL COMPONENTS IN LIFE SUPPORT DEVICES OR SYSTEMS WITHOUT THE EXPRESS WRITTEN APPROVAL OF THE PRESIDENT OF FAIRCHILD SEMICONDUCTOR CORPORATION. As used herein:

1. Life support devices or systems are devices or systems which, (a) are intended for surgical implant into the body, or (b) support or sustain life, and (c) whose failure to perform when properly used in accordance with instructions for use provided in the labeling, can be reasonably expected to result in a significant injury to the user.
2. A critical component in any component of a life support device or system whose failure to perform can be reasonably expected to cause the failure of the life support device or system, or to affect its safety or effectiveness.

**Fairchild Semiconductor Corporation**  
**Americas**  
 Customer Response Center  
 Tel: 1-888-522-5372

**Fairchild Semiconductor Europe**  
 Fax: +49 (0) 1 80-530 85 86  
 Email: europe.support@nsc.com  
 Deutsch Tel: +49 (0) 8 141-35-0  
 English Tel: +44 (0) 1 793-85-68-56  
 Italy Tel: +39 (0) 2 57 5631

**Fairchild Semiconductor Hong Kong Ltd.**  
 13th Floor, Straight Block,  
 Ocean Centre, 5 Canton Rd.  
 Tsimshatsui, Kowloon  
 Hong Kong  
 Tel: +852 2737-7200  
 Fax: +852 2314-0061

**National Semiconductor Japan Ltd.**  
 Tel: 81-3-5620-6175  
 Fax: 81-3-5620-6179

www.fairchildsemi.com