

Datasheet

BT830 Bluetooth v4.0 Dual-Mode UART HCI Module

Version 1.9



BT830 - SA

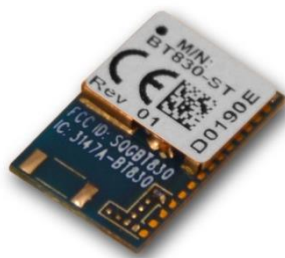

BT830 - ST

REVISION HISTORY

Revision	Date	Changes	Approved By
1.0	23 July 2014	Initial Version	Jonathan Kaye
1.1	10 Nov 2014	Updated pin definitions	Jonathan Kaye
1.2	10 Aug 2015	Added Tape/Reel information	Jonathan Kaye
1.3	30 Sept 2015	Added additional antenna information	Andrew Chen
1.4	15 Dec 2015	Replaced tray image with new one	Maggie Teng
1.5	17 Aug 2016	Changed <i>Hardware Integration Guide</i> to <i>Datasheet</i> .	Sue White
1.6	31 Aug 2016	Updated Declaration of Conformity	Tom Smith
1.7	16 May 2016	Updated Declaration of Conformity for RED standards	Tom Smith
1.8	07 Sept 2017	Added Japan (MIC) certification/antenna information Transferred to the new Laird template	Maggie Teng
1.9	05 Mar 2019	Updated logos and URLs	Sue White

CONTENTS

1	Scope	4
2	Operational Description	4
3	Block Diagram and Descriptions.....	5
4	Specifications	6
5	Pin Definitions.....	7
6	DC Electrical Characteristic.....	9
7	RF Characteristics	10
8	Interface	11
8.1	PIO.....	11
8.2	WLAN Coexistence Interface	11
8.3	UART Interface	12
8.4	PCM Interface	12
8.5	GCI Interface.....	14
8.6	Slots and Sample Formats	14
8.7	PCM Timing Information.....	15
8.8	PCM Slave Timing	18
8.9	PCM Slave Mode Timing Parameters	18
8.10	PCM_CLK and PCM_SYNC Generation.....	19
8.11	PCM Configuration.....	19
8.12	Digital Audio Interface (I ² S)	20
9	Power Supply and Regulation	22
9.1	Voltage Regulator Enable and Reset	22
9.2	Power Sequencing	23
10	Antenna Performance.....	23
10.1	Multilayer Chip Antenna	23
10.2	NanoBlade	25
11	Mechanical Dimensions and Land Pattern	26
12	Implementation Note	28
12.1	PCB Layout on Host PCB	28
13	Application Note for Surface Mount Modules	29
13.1	Introduction	29
13.2	Shipping	29
13.3	Reflow Parameters.....	31
14	FCC and IC Regulatory	32
15	European Union Regulatory	35
16	Japan (MIC) Certification.....	35
17	Ordering Information.....	36
18	Bluetooth SIG Approvals	37

1 SCOPE

This document describes key hardware aspects of the Laird BT830 Bluetooth HCI modules. This document is intended to assist device manufacturers and related parties, with the integration of this module into their host devices. Data in this document are drawn from a number of sources including data sheets for the CSR8811. Because the BT830 is currently in development stage, this document is preliminary and the information in this document is subject to change. Visit <https://connectivity.lairdtech.com/> to obtain the most recent version of this document.

2 OPERATIONAL DESCRIPTION

The BT830 series of UART HCI devices are designed to meet the needs of OEMs adding robust Bluetooth connectivity and using embedded Bluetooth stacks within their products.

Leveraging the market-leading CSR8811 chipset, the BT830 series provides exceptionally low power consumption with outstanding range. Supporting the latest Bluetooth v4.0 specification with EDR (Enhanced Data Rate), the Laird BT830 series enables OEMs to accelerate their development time for leveraging either Classic Bluetooth or Bluetooth Low Energy (BLE) into their operating system-based devices.

With a footprint as small as 8.5 x 13 mm, yet output power at 7 dBm, these modules are ideal for applications where designers need high performance in minimal size. For maximum flexibility in systems integration, the modules are designed to support a UART interface plus GPIO and additionally I2S and PCM audio interfaces.

These modules present an HCI interface and have native support for Windows and Linux Bluetooth software stacks. All BT830 series devices are fully qualified as Bluetooth Hardware Controller Subsystem products. This allows designers to integrate their existing pre-approved Bluetooth host and profile subsystem stacks to gain a Bluetooth END product approval for their products.

The BT830 series is engineered to provide excellent RF performance with integrated antenna and additional band pass filters. It further reduces regulatory and testing requirements for OEMs and ensures a hassle free development cycle.

A fully featured, low-cost developer's kit is available for prototyping, debug, and integration testing of the BT830 series modules and further reduces risk and time in development cycles.



BT830-SA module



BT830-ST module

BT830-SA BTv4.0 Dual Mode UART HCI Module (Integrated Antenna)

BT830-ST BTv4.0 Dual Mode UART HCI Module (SMT Pad for External Antenna)

Features and Benefits

- Bluetooth v4.0 - dual mode (Classic Bluetooth and BLE)
- Compact footprint
- 3-wire Wi-Fi coexistence scheme
- High antenna radiation gain and efficiency
- Good interference rejection for multi-com system (GSM/WCDMA)
- Class 1 output – 7 dBm
- UART, GPIO, I2S, and PCM
- Industrial temperature range
- Bluetooth hardware controller subsystem
- FCC, IC, and CE approvals
- Host Wake up

Application Areas

- Medical devices
- ePOS terminals
- Barcode scanners
- Industrial cable replacement
- M2M connectivity
- Automotive Diagnostic Equipment
- Personal Digital Assistants (PDA)
- Bluetooth HID device (keyboard, mouse, and joystick)

3 BLOCK DIAGRAM AND DESCRIPTIONS

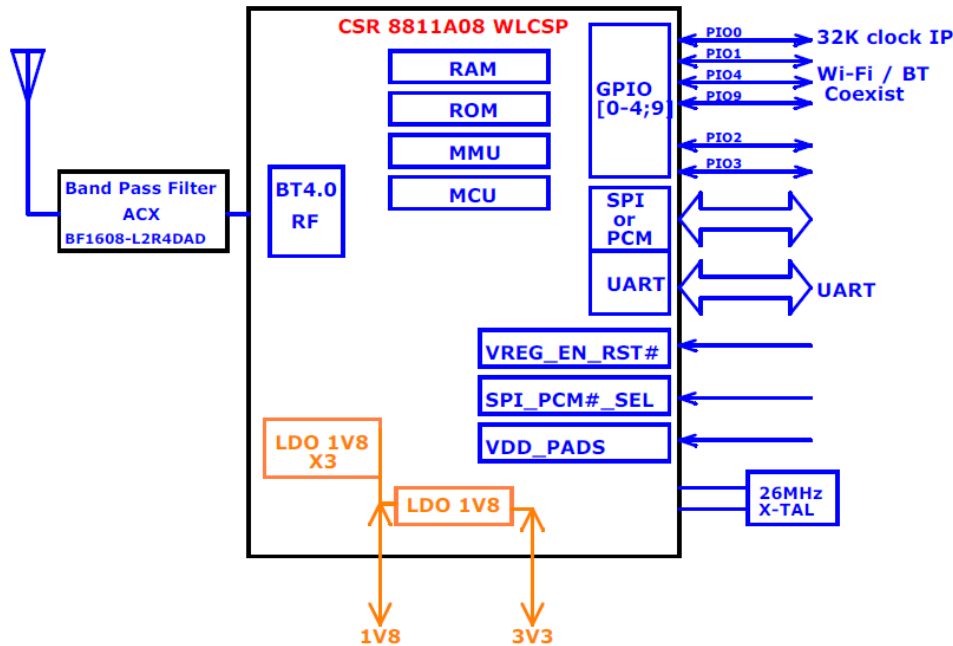

Figure 2: BT830 module block diagram

CS8811A08 (Main chip)

The BT830 is based on the CSR8811A08 dual mode chip. The chip is a single-chip radio with on-chip LDO regulators and baseband IC for Bluetooth 2.4 GHz systems including EDR to 3 Mbps.

Dedicated signal and baseband processing is included for full Bluetooth operation. The chip provides PCM/I2S and UART interfaces. Up to four general purpose I/Os are available for general use such as Wi-Fi coexistence or general indicators.

Note: The purpose of the SPI interface is to access the module’s inner settings such as selecting different WLAN CO-EXIST scheme. The SPI interface can also be used to place the module in RF test mode. You cannot use the module over the SPI interface for normal operation as the main host interface.

Antenna Options	BT830-SA – The antenna is a ceramic monopole chip antenna. BT830-ST – Provides a SMT pad for connecting an external antenna.
Band Pass Filter	The band pass filter filters the out-of-band emissions from the transmitter to meet the specific regulations for type approvals of various countries.
Crystal	The embedded 26 MHz crystal is used for generating the clock for the entire module.

4 SPECIFICATIONS

Table 1: BT830 specifications

Categories	Feature	Implementation
Wireless Specification	Bluetooth®	V4.0 Dual Mode
	Frequency	2.402 - 2.480 GHz
	Maximum Transmit Power	Class 1 +7 dBm from antenna
	Receive Sensitivity	-89 dBm
	Range	Circa 100 meters
	Data Rates	Up to 3 Mbps (over the air)
Host Interface	UART	RX, TX, CTS, RTS
	GPIO	Six configurable lines (1.8V/3.3V configurable by VDD_PADS)
Operational Modes	HCI	Host Controller Interface over UART
Coexistence	802.11 (Wi-Fi)	3 wire CSR schemes supported (Unity-3 and Unity-3e)
Supply Voltage	Supply	3.3V +/-10%
		Note: See Implementation Note for details on different DC power selections on the BT830.
Power Consumption	Current	Idle Mode ~4.3 mA (Master; ACL link; No traffic)
		File Transfer ~7.1 mA (Master; ACL link; Transmit)
Antenna Option	Internal (BT830-SA)	Multilayer ceramic antenna with up to 40% efficiency.
	External (BT830-ST)	SMT pad for external antenna
Physical	Dimensions	8.5 x 13 x 1.6 mm (BT830 - module)
Environmental	Operating	-30 °C to +85 °C
	Storage	-40 °C to +85 °C
Miscellaneous	Lead Free	Lead-free and RoHS compliant
	Warranty	1-Year Warranty
Approvals	Bluetooth®	Hardware Controller Subsystem Approved
	FCC / IC / CE	All BT830 series (BT830-SA; BT830-ST)

5 PIN DEFINITIONS

Table 2: BT830 pin definitions

#	Pin Name	I/O	Supply Domain	Description	If Unused...
1	VDD_PADS	DC voltage input	(1.75V-3.6V)	Positive DC supply for configuring digital I/O level.	N/A
2	GND	GND	-	Ground	GND
3	PIO2	Bidirectional, tri-state, with weak internal pull-down	VDD_PADS	Programmable input/output line	NC
4	UART_RTS	Bidirectional, tri-state, with weak internal pull-up	VDD_PADS	UART request to send, active low	NC
5	UART_TX	Bidirectional, tri-state, with weak internal pull-up	VDD_PADS	UART data output, active high	NC
6	UART_CTS	Bidirectional, tri-state, with weak internal pull-up	VDD_PADS	UART clear to send, active low	NC
7	UART_RX	Bidirectional, tri-state, with weak internal pull-up	VDD_PADS	UART data input, active high	NC
8	VREG_EN_RST#	Input with strong internal pull-down	VDD_PADS	Take high to enable internal regulators. Also acts as active low reset. Maximum voltage is VDD_PADS.	N/A
9	VREG_IN_HV	Analogue regulator input	3.3V	Module main DC power supply; Input to internal high-voltage regulator	N/A
10	VREG_OUT_HV	Analogue regulator input/output	1.8V	Output from internal high-voltage regulator and input to low-voltage internal regulators.	N/C
11	GND	GND	-	Ground	GND
12	GND	GND	-	Ground	GND
13	GND	GND	-	Ground	GND
14	GND	GND	-	Ground	GND
15	GND	GND	-	Ground	GND
16	GND	GND	-	Ground	GND
17	RF			BT830-ST – RF signal out (50 ohm) BT830-SA – No connection	
18	GND	GND	-	Ground	GND

#	Pin Name	I/O	Supply Domain	Description	If Unused...
19	PCM_SYNC/ SPI_CS#/ PIO23	Bidirectional, tri-state, with weak internal pull-down	VDD_PADS	PCM synchronous data sync SPI chip select, active low programmable input/output line *See Note 1 .	NC
20	PCM_CLK/ SPI_CLK/ PIO24	Bidirectional, tri-state, with weak internal pull-down	VDD_PADS	PCM synchronous data clock SPI clock Programmable input/output line *See Note 1 .	NC
21	PCM_IN/ SPI_MOSI/ PIO21	Input, tri-state, with weak internal pull-down	VDD_PADS	PCM synchronous data input SPI data input Programmable input/output line *See Note 1 .	NC
22	PCM_OUT/ SPI_MISO/ PIO22	Output, tri-state, with weak internal pull-down	VDD_PADS	PCM synchronous data output SPI data output Programmable input/output line *See Note 1 .	NC
23	GND	GND	-	Ground	GND
24	PIO0/ 32K_CLK_IN	Bidirectional, tri-state, with weak internal pull-down	VDD_PADS	Programmable input/output line and 32kHz sleep clock input	NC
25	PIO1/ BT_ACTIVE	Bidirectional, tri-state, with weak internal pull-down	VDD_PADS	Programmable input/output line; Wi-Fi and BT 3-wire coexistence	NC
26	PIO9/ BT_PRIORITY	Bidirectional, tri-state, with weak internal pull-down	VDD_PADS	Programmable input/output line; Wi-Fi and BT 3-wire coexistence	NC
27	PIO4/ WLAN_ACTIVE	Bidirectional, tri-state, with weak internal pull-down	VDD_PADS	Programmable input/output line; Wi-Fi and BT 3-wire coexistence	NC
28	SPI_PCM#_SEL	Input with weak internal pull-down	VDD_PADS	Control line to select SPI or PCM interface, high = SPI, low = PCM *See Note 1 .	NC
29	PIO3/ Host Wake up	Bidirectional, tri-state, with weak internal pull-down	VDD_PADS	Programmable input/output line; Host wake up from BT, active High.	NC
30	GND	GND	-	Ground	GND

Note 1: The purpose of the SPI interface is to access the module's inner settings such as selecting different WLAN COEXIST scheme. The SPI interface can also be used to put the module in RF test mode. You cannot use the module over the SPI interface for normal operation as the main host interface.

6 DC ELECTRICAL CHARACTERISTIC

Table 3: Absolute maximum ratings

Rating	Min	Max	Unit
Storage temperature	-40	+85	°C
VREG_IN_HV	2.3	4.8	V
VREG_OUT_HV	1.7	2.0	V
VDD_PADS	-0.4	3.6	V
Other terminal voltages	-0.4	VDD_PADS + 0.4 V	V

Table 4: Recommended operating conditions

Rating	Min	Max	Unit
Operating temperature	-30	+85	°C
VREG_IN_HV	3.0	3.6	V
VREG_OUT_HV	1.75	1.95	V
VDD_PADS	1.75	3.6	V
VREG_EN_RST#	VDD_PADS	VDD_PADS	V

Table 5: High-voltage Linear Regulator

Normal Operation	Min	Typ	Max	Unit
Input voltage (VREG_IN_HV)	3.0	3.3	3.6	V
Output voltage (VREG_OUT_HV)	1.75	1.85	1.95	V
Temperature coefficient	-200	-	200	ppm/°C
Output noise (frequency range 100Hz to 100kHz)	-	-	0.4	mV rms
Settling time (settling time within 10% of final value)	-	-	5	µs
Output current	-	-	100	mA

Table 6: Digital I/O Characteristics

Normal Operation	Min	Typ	Max	Unit
Input Voltage				
VIL input logic level low	-0.4	-	0.4	V
VIH input logic level high	0.7 x VDD_PADS	-	VDD_PADS + 0.4	V
Output Voltage				
VOL output logic level low, IOL = 4.0 mA	-	-	0.4	V
VOH output logic level high, IOL = 4.0 mA	0.75 x VDD_PADS	-	-	V
Input and Tristate Currents				
Strong pull-up	-150	-40	-10	μA
Strong pull-down	10	40	150	μA
Weak pull-up	-5	-1.0	-0.33	μA
Weak pull-down	0.33	1.0	5.0	μA
CI input capacitance	1.0	-	5.0	pF

Table 7: Current Consumption

Normal Operation	Avg.	Unit
Idle	5	mA
Inquiry	891	μA
File Transfer (ACL) Transmit (Master)	7.1	mA
Receive (Slave)	11.5	mA
LE Connected (Master)	292	μA
LE Scan (Master)	448	μA

Current consumption values are taken with:

- VREG_IN_HV pin = 3.15V
- RF TX power set to 0dBm
- XTAL used with PSKEY_LP_XTAL_LVL = 8
- LEDs disconnected

7 RF CHARACTERISTICS

Table 8: RF Characteristics

RF Characteristics, VREG_IN_HV/VDD_PADS = 3.3V @ room temperature unless otherwise specified	Min	Typ.	Max	BT. Spec.	Unit
Maximum RF Transmit Power		7	8	20	dBm
RF power variation over temperature range		1.5		-	dB
RF power variation over supply voltage range			0.2	-	dB
RF power variation over BT band		3		-	dB
RF power control range	-21		8	-	dBm
20 dB band width for modulated carrier				1000	kHz

ACP	$F = F_0 \pm 2\text{MHz}$	-20	
	$F = F_0 \pm 3\text{MHz}$	-40	
	$F = F_0 > 3\text{MHz}$	-40	
Drift rate	5	≤ 20	kHz
$\Delta F_{1\text{avg}}$	165	140<175	kHz
$\Delta F_{1\text{max}}$	168	140<175	kHz
$\Delta F_{2\text{avg}} / \Delta F_{1\text{avg}}$	0.9	≥ 0.8	

Table 9: BDR and EDR receiver sensitivity

RF Characteristics, VREG_IN_HV/VDD_PADS = 3.3V @ room temp.	Packet Type	Min	Typ	Max	BT. Spec.	Unit
Sensitivity for 0.1% BER	DH1		-87		-70	dBm
	DH3		-87			dBm
	DH5		-87			dBm
	2-DH5		-91			dBm
	3-DH5		-85			dBm
Sensitivity variation over BT band	All		3			dB
Sensitivity variation over temperature range	All		TBD			dB

8 INTERFACE

8.1 PIO

PIO lines are configured through software to have either weak or strong pull-ups or pull-downs. All PIO lines are configured as inputs with weak pull-downs at reset and have additional individual bus-keeper configuration.

8.2 WLAN Coexistence Interface

Dedicated hardware is provided to implement a variety of WLAN coexistence schemes. The following are supported:

- Channel skipping AFH
- Priority signaling
- Channel signaling
- Host passing of channel instructions

The BT830 supports the following WLAN coexistence schemes:

- Unity-3
- Unity-3e

More information is available in the BT830 Configuration File application note, available on the documentation tab of the [BT830 Product Page at Lairdtech.com](#).

8.3 UART Interface

This is a standard UART interface for communicating with other serial devices. The CSR8811 UART interface provides a simple mechanism for communicating with other serial devices using the RS-232 protocol.

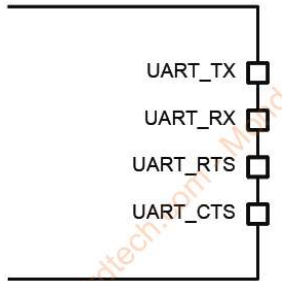

Figure 1: Signals that implement the UART function

The above figure shows the four signals that implement the UART function. When BT830 is connected to another digital device, UART_RX and UART_TX transfer data between the two devices. The remaining two signals, UART_CTS and UART_RTS, implement RS232 hardware flow control where both are active low indicators. The default configuration of UART is 115200 bauds; None parity check; 1 stop bit; 8 bits per byte.

Note: With a standard PC, an accelerated serial port adapter card is required to communicate with the UART at its maximum data rate.

8.4 PCM Interface

The audio PCM interface on the BT830 supports the following:

- Continuous transmission and reception of PCM encoded audio data over Bluetooth.
- Processor overhead reduction through hardware support for continual transmission and reception of PCM data.
- A bidirectional digital audio interface that routes directly into the baseband layer of the firmware. It does not pass through the HCI protocol layer.
- Hardware on the BT830 for sending data to and from a SCO connection.
- Up to three SCO connections on the PCM interface at any one time.
- PCM interface master, generating PCM_SYNC and PCM_CLK.
- PCM interface slave, accepting externally generated PCM_SYNC and PCM_CLK.
- Various clock formats including:
 - Long Frame Sync
 - Short Frame Sync
- GCI timing environments.
- 13-bit or 16-bit linear, 8-bit μ -law, or A-law companded sample formats.
- Receives and transmits on any selection of three of the first four slots following PCM_SYNC.

The PCM configuration options are enabled by setting PSKEY_PCM_CONFIG32.

8.4.1 PCM Interface Master/Slave

When configured as the master of the PCM interface, the BT830 generates PCM_CLK and PCM_SYNC.

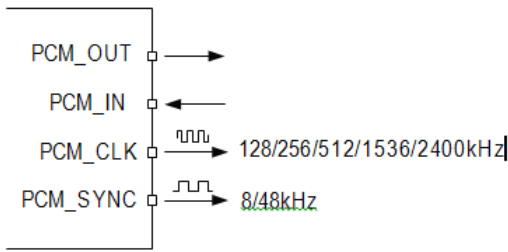

Figure 2: PCM Interface Master

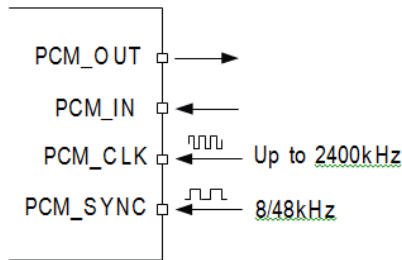

Figure 3: PCM Interface Slave

8.4.2 Long Frame Sync

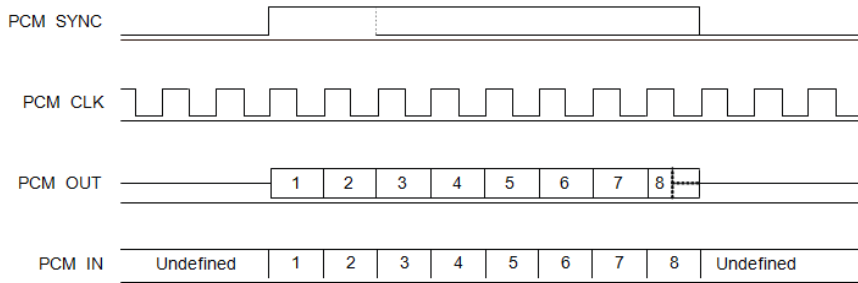

Figure 4: Long Frame Sync (shown with 8-bit Companded Sample)

Long Frame Sync indicates a clocking format that controls the transfer of PCM data words or samples. In Long Frame Sync, the rising edge of PCM_SYNC indicates the start of the PCM word. When the BT830 is configured as PCM master, generating PCM_SYNC and PCM_CLK, then PCM_SYNC is eight bits long. When the BT830 is configured as PCM Slave, PCM_SYNC is from one cycle PCM_CLK to half the PCM_SYNC rate.

BT830 samples PCM_IN on the falling edge of PCM_CLK and transmits PCM_OUT on the rising edge. PCM_OUT is configurable as high impedance on the falling edge of PCM_CLK in the LSB position or on the rising edge.

8.4.3 Short Frame Sync

In Short Frame Sync, the falling edge of PCM_SYNC indicates the start of the PCM word. PCM_SYNC is always one clock cycle long.

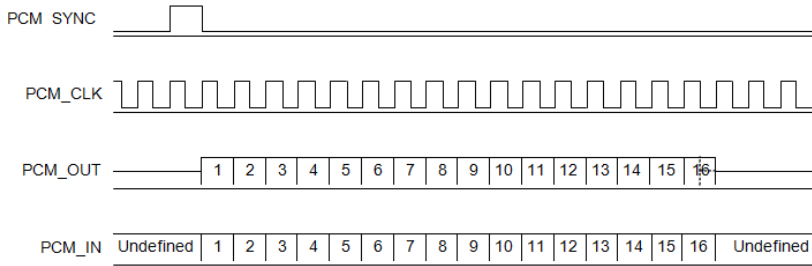

Figure 5: Short Frame Sync (Shown with 16-bit Sample)

As with Long Frame Sync, BT830 samples PCM_IN on the falling edge of PCM_CLK and transmits PCM_OUT on the rising edge. PCM_OUT is configurable as high impedance on the falling edge of PCM_CLK in the LSB position or on the rising edge.

8.4.4 Multi-Slot Operation

More than one SCO connection over the PCM interface is supported using multiple slots. Up to three SCO connections are carried over any of the first four slots.

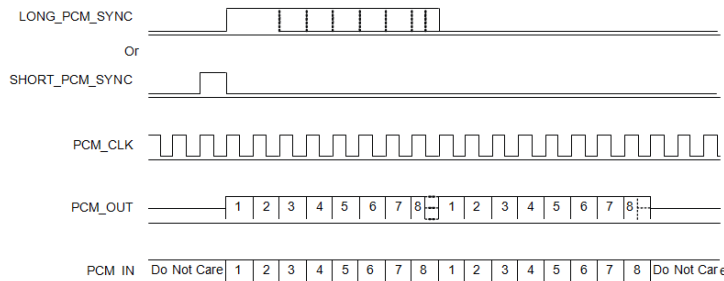

Figure 6: Multi-slot operation with 2 Slots and 8-bit companded samples

8.5 GCI Interface

BT830 is compatible with the GCI, a standard synchronous 2B+D ISDN timing interface. The two 64 kbps B channels are accessed when this mode is configured.

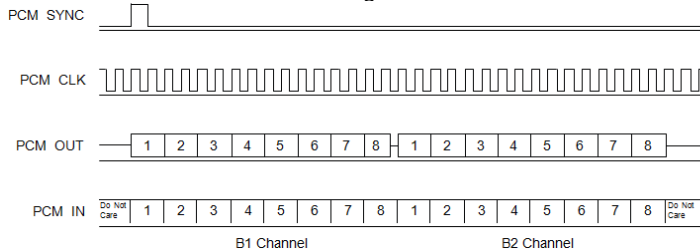

Figure 7: Multi-slot operation

The start of frame is indicated by the rising edge of PCM_SYNC and runs at 8 kHz.

8.6 Slots and Sample Formats

BT830 receives and transmits on any selection of the first four slots following each sync pulse. Slot durations are either 8 or 16 clock cycles:

- 8 clock cycles for 8-bit sample formats
- 16 clock cycles for 8-bit, 13-bit, or 16-bit sample formats

BT830 supports:

- 13-bit linear, 16-bit linear, and 8-bit μ -law or A-law sample formats
- A sample rate of 8 ksp/s

- Little or big endian bit order
- For 16-bit slots, the three or eight unused bits in each slot are filled with sign extension, padded with zeros or a programmable 3-bit audio attenuation compatible with some codecs.

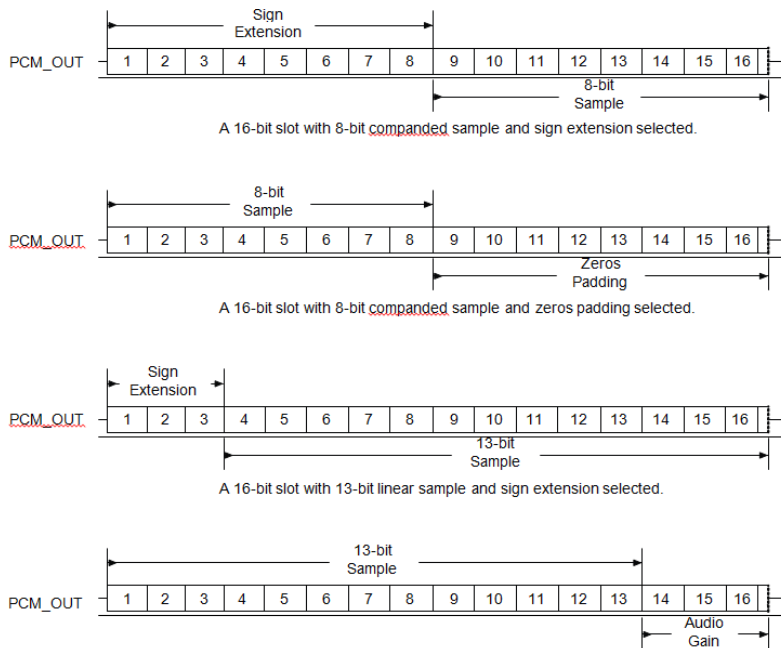

Figure 8: 16-bit slot Length and sample formats

8.7 PCM Timing Information

Table 10: PCM Timing information

Symbol	Parameter	Min	Typ	Max	Unit	
fmclk	PCM_CLK frequency	4MHz DDS generation. Frequency selection is programmable.	-	128	-	kHz
				256		
				512		
	48MHz DDS generation. Frequency selection is programmable.	2.9	-	-	kHz	
-	PCM_SYNC frequency for SCO connection	-	8	-	kHz	
tmclkh (a)	PCM_CLK high	4MHz DDS generation	980	-	ns	
tmclkl a)	PCM_CLK low	4MHz DDS generation	730	-	ns	
-	PCM_CLK jitter	48MHz DDS generation	-	-	21 pk-pk	
tdmclksynch	Delay time from PCM_CLK high to PCM_SYNC high	4MHz DDS generation	-	-	20	ns
		48MHz DDS generation	-	-	40.83	ns
tdmclkpout	Delay time from PCM_CLK high to valid PCM_OUT	-	-	20	ns	
tdmclksyncl	Delay time from PCM_CLK low to PCM_SYNC low (long frame sync only)	4MHz DDS generation	-	-	20	ns
		48MHz DDS generation	-	-	40.83	ns

(a) Assumes normal system clock operation. Figures vary during low-power modes, when system clock speeds are reduced.

Table 11: PCM Master Mode Timing Parameters

Symbol	Parameter	Min	Typ	Max	Unit
tdmclkhsyncl	Delay time from PCM_CLK high to PCM_SYNC low	-	-	20	ns
	48MHz DDS generation	-	-	40.83	ns
tdmclkpoutz	Delay time from PCM_CLK low to PCM_OUT high impedance	-	-	20	ns
tdmclkhoutz	Delay time from PCM_CLK high to PCM_OUT high impedance	-	-	20	ns
tsupinckl	Set-up time for PCM_IN valid to PCM_CLK low	20	-	-	ns
thpinckl	Hold time for PCM_CLK low to PCM_IN invalid	0	-	-	ns

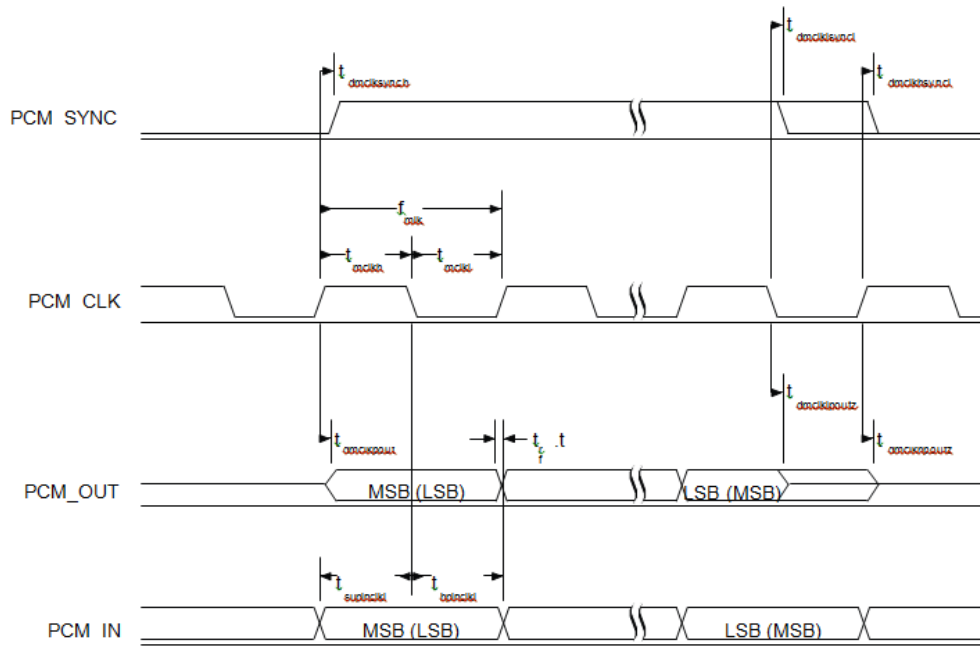

Figure 9: PCM Master Timing Long Frame Sync

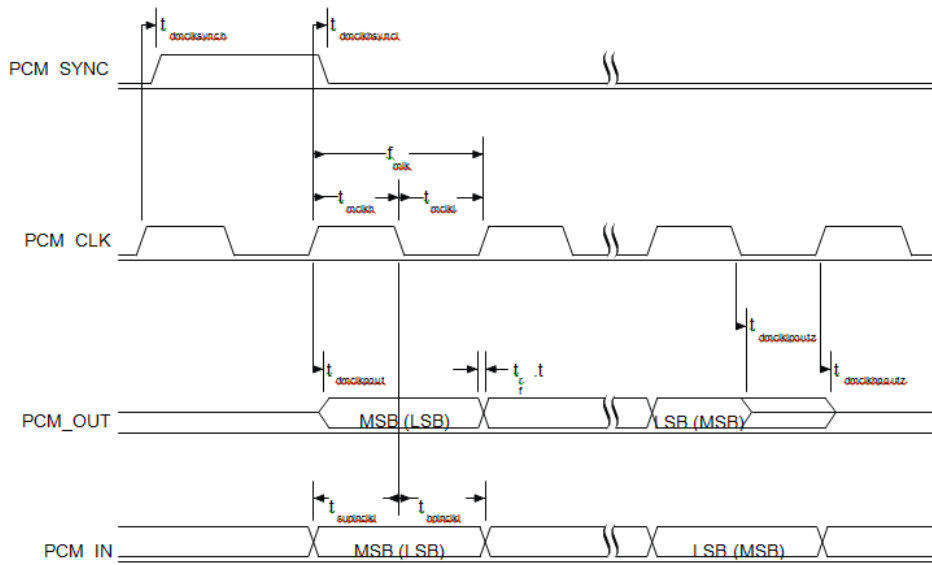

Figure 10: PCM Master Timing Short Frame Sync

8.8 PCM Slave Timing

Symbol	Parameter	Min	Typ	Max	Unit
fclk	PCM clock frequency (Slave mode: input)	64	-	2048	kHz
fclk	PCM clock frequency (GCI mode)	128	-	4096	kHz
tsckl	PCM_CLK low time	200	-	-	ns
tsckh	PCM_CLK high time	200	-	-	ns

8.9 PCM Slave Mode Timing Parameters

Symbol	Parameter	Min	Typ	Max	Unit
thclkynch	Hold time from PCM_CLK low to PCM_SYNC high	2	-	-	ns
tsusclkynch	Set-up time for PCM_SYNC high to PCM_CLK low	20	-	-	ns
tdpout	Delay time from PCM_SYNC or PCM_CLK, whichever is later, to valid PCM_OUT data (long frame sync only)	-	-	15	ns
tdsckhpout	Delay time from CLK high to PCM_OUT valid data	-	-	15	ns
tdpoutz	Delay time from PCM_SYNC or PCM_CLK low, whichever is later, to PCM_OUT data line high impedance	-	-	20	ns
tsupinsckl	Set-up time for PCM_IN valid to CLK low	20	-	-	ns
thpinsckl	Hold time for PCM_CLK low to PCM_IN invalid	2	-	-	ns

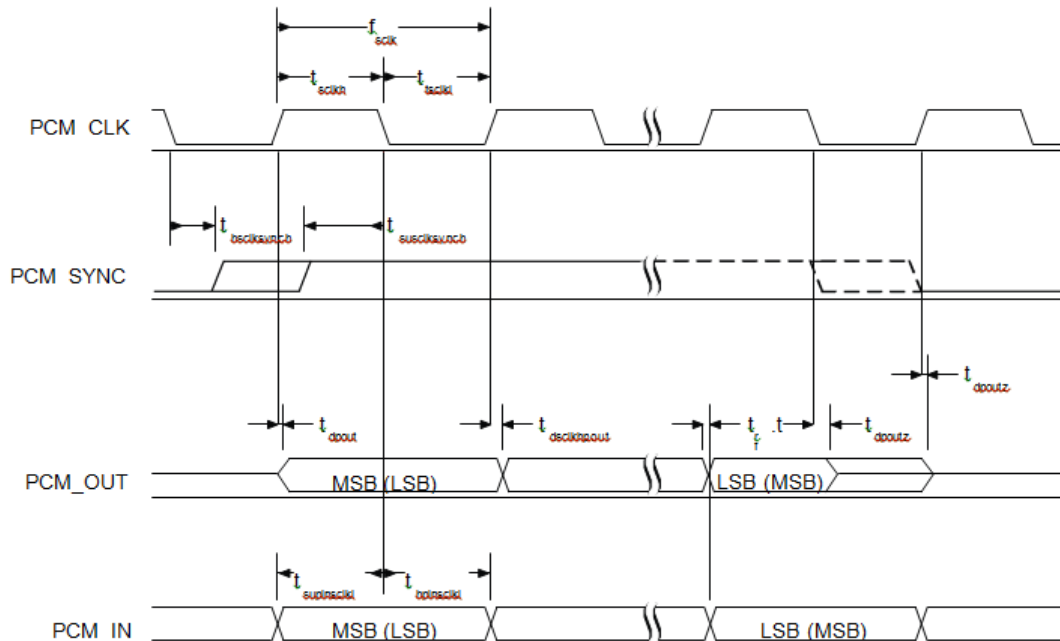

Figure 11: PCM Slave Timing Long Frame Sync

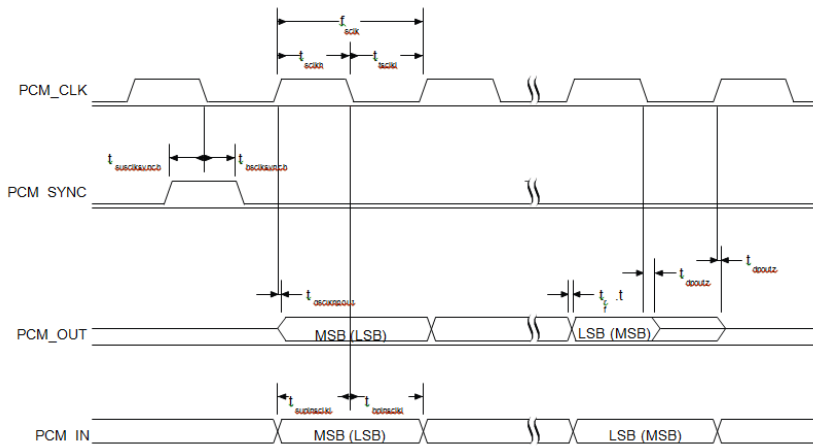

Figure 12: PCM Slave Timing Short Frame Sync

8.10 PCM_CLK and PCM_SYNC Generation

BT830 has two methods of generating PCM_CLK and PCM_SYNC in master mode:

- Generating these signals by DDS from BT830 internal 4MHz clock. Using this mode limits PCM_CLK to 128, 256 or 512 kHz and PCM_SYNC to 8 kHz.
- Generating these signals by DDS from an internal 48MHz clock enables a greater range of frequencies to be generated with low jitter but consumes more power. To select this second method, set bit to 48M_PCM_CLK_GEN_EN in PSKEY_PCM_CONFIG32. When in this mode and with long frame sync, the length of PCM_SYNC is either 8 or 16 cycles of PCM_CLK, determined by LONG_LENGTH_SYNC_EN in PSKEY_PCM_CONFIG32.

Equation 8.1 describes PCM_CLK frequency when generated from the internal 48MHz clock:

$$f = \frac{\text{CNT_RATE}}{\text{CNT_LIMIT}} \times 24\text{MHz}$$

Equation 8.1: PCM_CLK Frequency Generated Using the Internal 48MHz Clock

Set the frequency of PCM_SYNC relative to PCM_CLK using Equation 8.2:

$$f = \frac{\text{PCM_CLK}}{\text{SYNC_LIMIT} \times 8}$$

Equation 8.2: PCM_SYNC Frequency Relative to PCM_CLK

CNT_RATE, CNT_LIMIT and SYNC_LIMIT are set using PSKEY_PCM_LOW_JITTER_CONFIG. As an example, to generate PCM_CLK at 512kHz with PCM_SYNC at 8kHz, set SKEY_PCM_LOW_JITTER_CONFIG to 0x08080177.

8.11 PCM Configuration

Configure the PCM by using PSKEY_PCM_CONFIG32 and PSKEY_PCM_LOW_JITTER_CONFIG (see your PSKey file). The default for PSKEY_PCM_CONFIG32 is 0x00800000.

For example: First slot following sync is active, 13-bit linear voice format, long frame sync and interface master generating 256kHz PCM_CLK from 4MHz internal clock with no tri-state of PCM_OUT).

8.12 Digital Audio Interface (I²S)

The digital audio interface supports the industry standard formats for I²S, left-justified or right-justified. The interface shares the same pins as the PCM interface which means each audio bus is mutually exclusive in its usage. Table 12 lists these alternative functions. Figure 11 shows the timing diagram.

Table 12: Alternative Functions of the Digital Audio Bus Interface on the PCM Interface.

PCM Interface	I ² S Interface
PCM_OUT	SD_OUT
PCM_IN	SD_IN
PCM_SYNC	WS
PCM_CLK	SCK

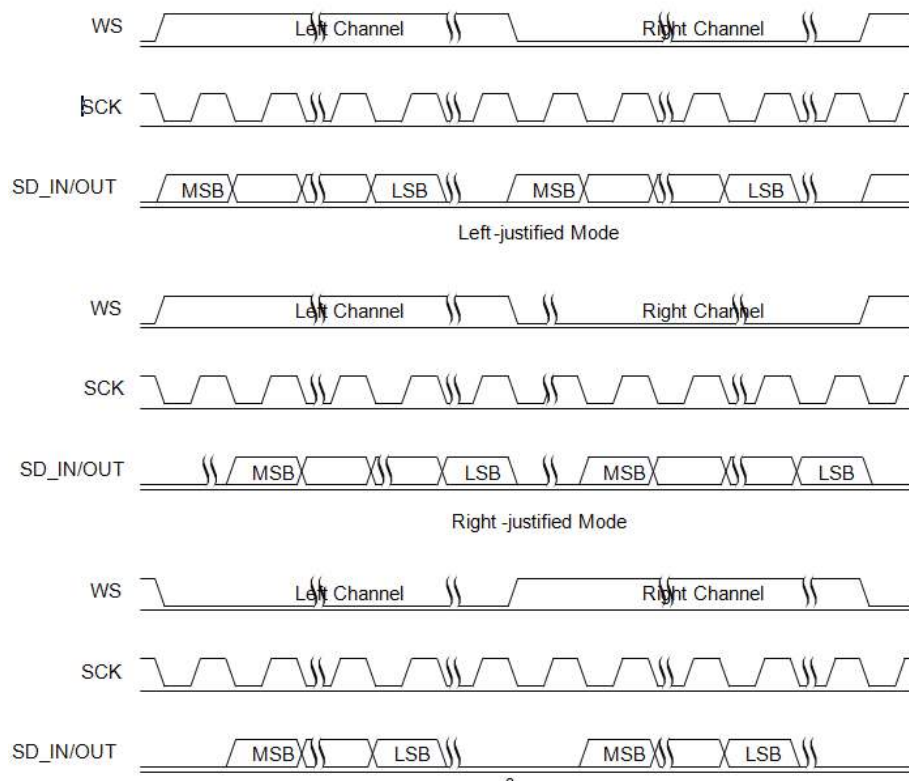

Figure 13: PCM Configuration

The internal representation of audio samples within BT830 is 16-bit and data on SD_OUT is limited to 16-bit per channel.

Table 13: Digital Audio Interface Slave Timing

Symbol	Parameter	Min	Typ	Max	Unit
-	SCK Frequency	-	-	6.2	MHz
-	WS Frequency	-	-	96	kHz
t _{ch}	SCK high time	80	-	-	ns
t _{cl}	SCK low time	80	-	-	ns

Table 14: I²S Slave Mode Timing

Symbol	Parameter	Min	Typ	Max	Unit
t _{ssu}	WS valid to SCK high set-up time	20	-	-	ns
t _{sh}	SCK high to WS invalid hold time	2.5	-	-	ns
t _{opd}	SCK low to SD_OUT valid delay time	-	-	20	ns
t _{isu}	SD_IN valid to SCK high set-up time	20	-	-	ns
t _{ih}	SCK high to SD_IN invalid hold time	2.5	-	-	ns

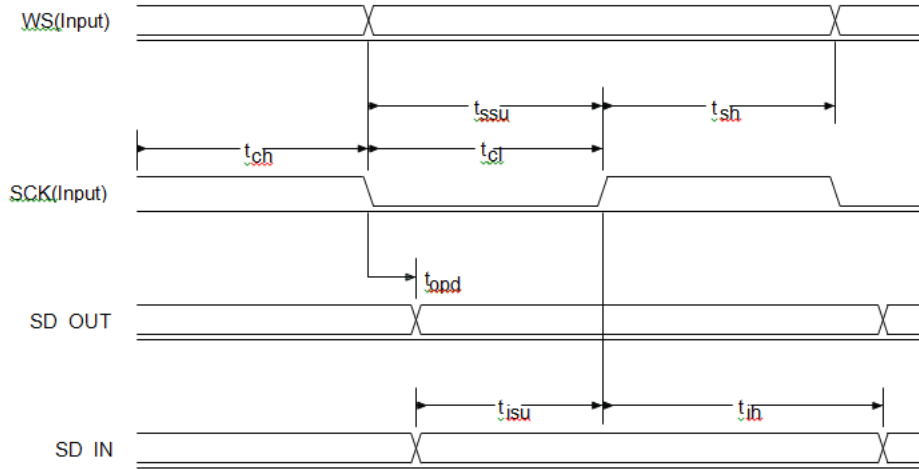

Figure 14: Digital Audio Interface Slave Timing

Table 15: Digital Audio Interface Master Timing

Symbol	Parameter	Min	Typ	Max	Unit
-	SCK Frequency	-	-	6.2	MHz
-	WS Frequency	-	-	96	kHz

Table 16: I²S Master Mode Timing Parameters, WS and SCK as Outputs

Symbol	Parameter	Min	Typ	Max	Unit
t _{spd}	SCK low to WS valid delay time	-	-	39.27	ns
t _{opd}	SCK low to SD_OUT valid delay time	-	-	18.44	ns
t _{isu}	SD_IN valid to SCK high set-up time	18.44	-	-	ns
t _{ih}	SCK high to SD_IN invalid hold time	0	-	-	ns

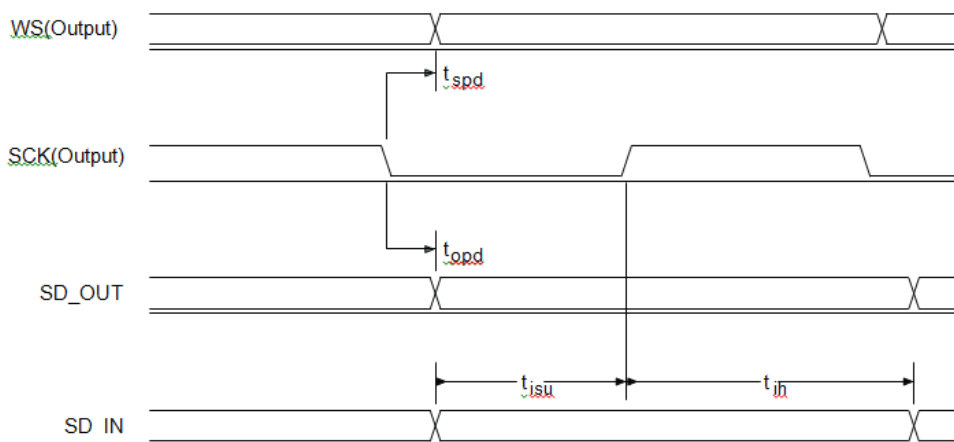

Figure 15: Digital Audio Interface Master Timing

9 POWER SUPPLY AND REGULATION

BT830 can be powered by either of the two sources listed below:

Method #1 – Apply 3.3 V on pin-9, High-voltage linear regulator input (VREG_IN_HV), to generate the main 1.8 V out put on pin-10 (VREG_OUT_HV).

A minimum 1.5 μ F capacitor must be connected to the Pin-10 (VREG_OUT_HV). Low ESR capacitors such as multilayer ceramic types should be used. In this case, the VDD_PADS can be either 3.3V or 1.8V.

Method #2 – Apply 1.8V on pin-10 High-voltage linear regulator output (VREG_OUT_HV), to generate the internal voltage for the system. Be sure to left Pin-9 un-connected in this method. In this case, the VDD_PADS can only be set at 1.8V.

Note: The I/O signal voltage level (VDD_PADS) should be equal or less than the power supply mentioned voltage above.

9.1 Voltage Regulator Enable and Reset

A single pin, VREG_EN_RST#, controls both the high-voltage linear regulator enables and the digital reset function. The VREG_EN_RST# pin remains active controlling the reset function if the HV linear regulator is not used; the pin must be driven high to take the device out of reset.

The regulator is enabled by taking the VREG_EN_RST# pin above 1.0V. The regulator can also be controlled by the software.

The VREG_EN_RST# is also connected internally to the reset function, and is powered from the VDD_PADS supply, so voltages above VDD_PADS must not be applied to this pin. The VREG_EN_RST# pin is pulled down internally.

The VREG_EN_RST# pin is an active low reset. Assert the reset signal for a period greater than five milliseconds to ensure a full reset.

Note: The regulator enables are released as soon as VREG_EN_RST# is low, so the regulators shut down. Therefore do not take VREG_EN_RST# low for less than five milliseconds, as a full reset is not guaranteed.

Other reset sources are:

- Power-on reset
- Via a software-configured watchdog timer

A warm reset function is also available under software control. After a warm reset the RAM data remains available.

9.2 Power Sequencing

CSR recommends that all power supplies are powered at the same time. The order of powering the supplies relative to the I/O supply, VDD_PADS to VREG_IN_HV or VREG_OUT_HV, is not important.

10 ANTENNA PERFORMANCE

10.1 Multilayer Chip Antenna

Figure 16 illustrates this antenna's performance.

Unit in dBi @2.44GHz	XY-plane		XZ-plane		YZ-plane		Efficiency
	Peak	Avg.	Peak	Avg.	Peak	Avg.	
AT3216-B2R7HAA	-2.2	-5.9	-0.7	-5.0	-1.3	-3.7	40%

Figure 16: BT830 gain table for the multilayer chip antenna

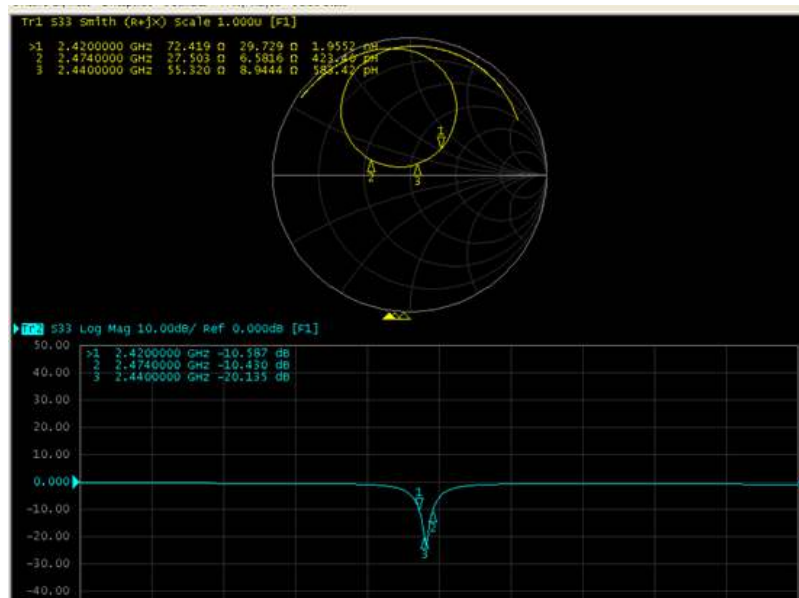
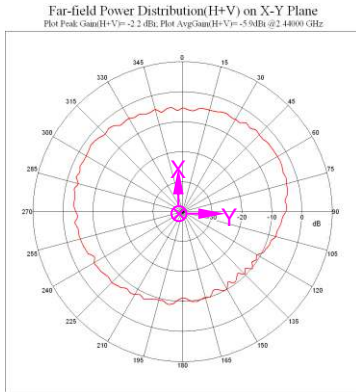

Figure 17: Network Analyzer output

XY-plane



Unit : dBi

	Peak gain	Avg. gain
XY-plane	-2.2	-5.9

XZ-plane

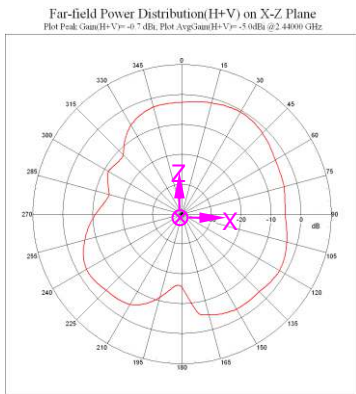

	Peak gain	Avg. gain
XZ-plane	-0.7	-5.0

YZ-plane

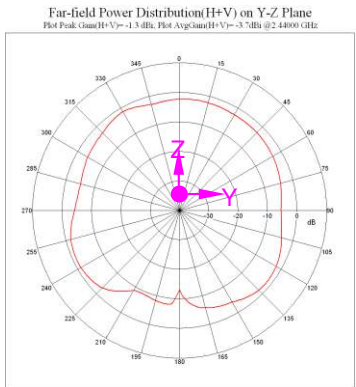

	Peak gain	Avg. gain
YZ-plane	-1.3	-3.7

10.2 NanoBlade

The following describes the performance of the NanoBlue antenna (EBL2449A1-15UFL):

Parameter	Performance
Frequency Range	2.4-2.5 GHz
Gain	2.0 dBi
Polarization	Linear
Impedance	50 ohms
VSWR	<2.0:1
Dimensions (L x W x H)	1.88 in x .5 in x .032 in
Weight	2 grams

XY-plane

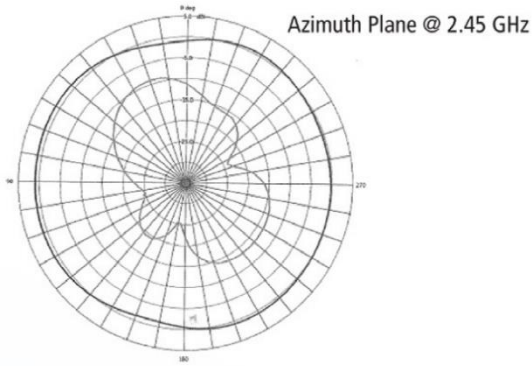

XZ-plane

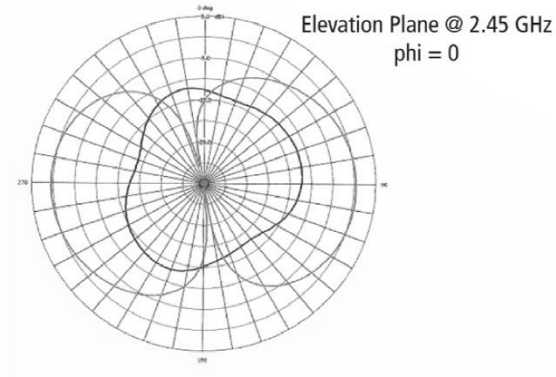

YZ-plane

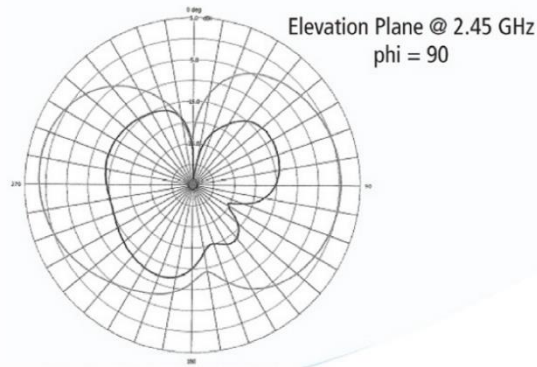

11 MECHANICAL DIMENSIONS AND LAND PATTERN

11.1 BT830-SA Mechanical Drawing

Bottom View Device Pads

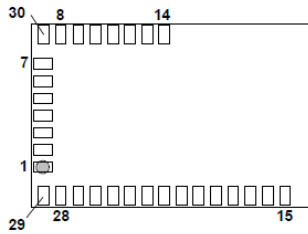

Side View

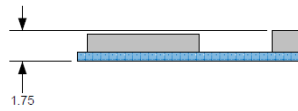

Top View Recommended PCB Layout

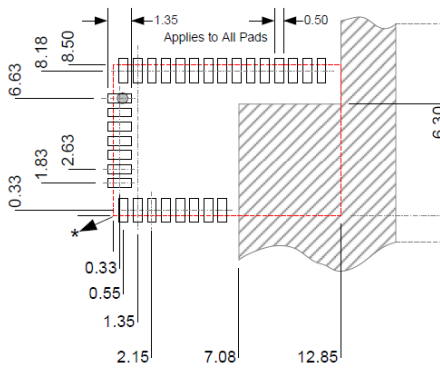

Top View

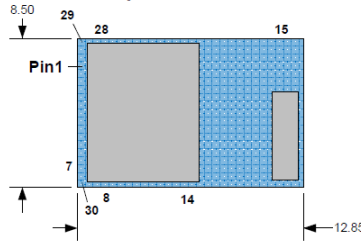

* Dimensions from corner of BT830 edge

● Pin1

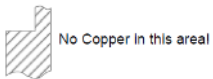

Note: Dimensions are in millimetres (mm).
 Tolerances: .xx ±0.03 mm for PCB PAD; +/-0.15mm for module size.
 .x ±1.3 mm

11.2 BT830-ST Mechanical Drawing

Bottom View Device Pads

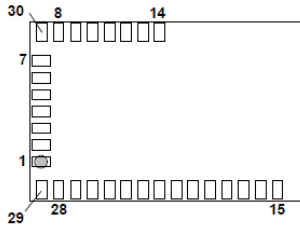

Side View

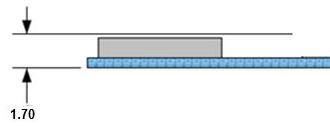

Top View
 Recommended PCB Layout

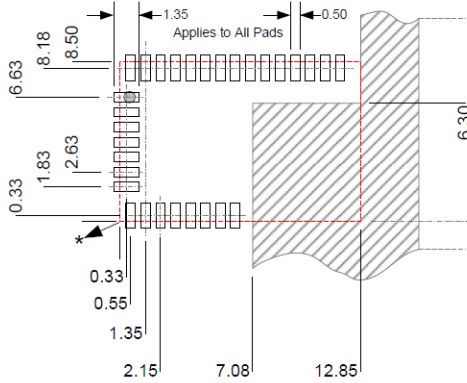

Top View

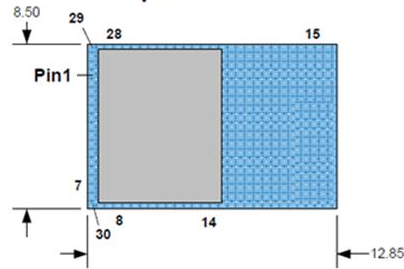

* Dimensions from corner of BT830 edge

● Pin1

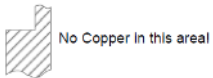

Note: Dimensions are in millimetres (mm).
 Tolerances: .xx ±0.03 mm for PCB PAD; +/0.15mm for module size.
 .x ±1.3 mm

12 IMPLEMENTATION NOTE

12.1 PCB Layout on Host PCB

Checklist (for PCB):

- **Must locate the BT830 module close to the edge of PCB.**
- Use solid GND plane on inner layer (for best EMC and RF performance).
- Place GND vias as close to module GND pads as possible
- Route traces to avoid noise being picked up on VCC supply.
- Antenna Keep-out area:
 - Ensure there is no copper in the antenna keep-out area on any layers of the host PCB.
 - Keep all mounting hardware and metal clear of the area to allow proper antenna radiation.
 - For best antenna performance, place the BT830 module on the edge of the host PCB, preferably in the corner with the antenna facing the corner.
 - A different host PCB thickness dielectric will have small effect on antenna.

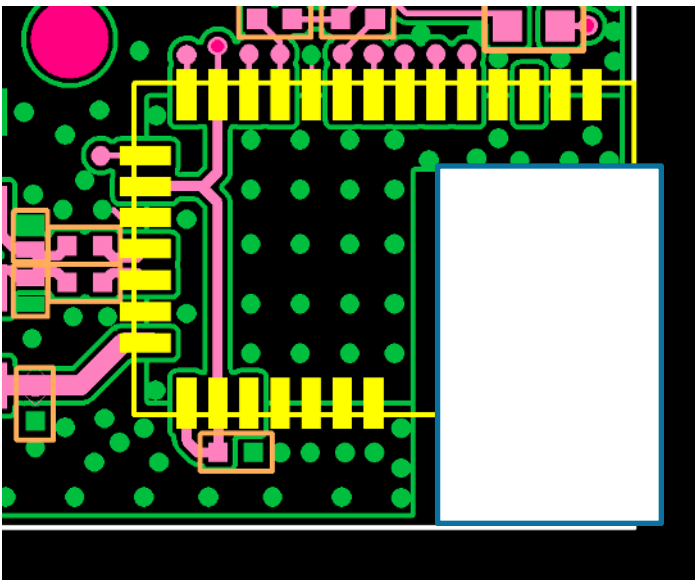

Figure 18: Recommend Antenna keep-out area (in White) used on the BT830-SA

12.1.1 Antenna Keep-out and Proximity to Metal or Plastic

Checklist (for metal /plastic enclosure):

- Minimum safe distance for metals without seriously compromising the antenna (tuning) is 40 mm top/bottom and 30 mm left or right.
- Metal close to the BT830-SA chip monopole antenna (bottom, top, left, right, any direction) will have degradation on the antenna performance. The amount of degradation is entirely system dependent which means some testing by customers is required (in their host application).
- Any metal closer than 20 mm starts to significantly degrade performance (S11, gain, radiation efficiency).
- It is best that the customer tests the range with mock-up (or actual prototype) of the product to assess effects of enclosure height (and material whether metal or plastic).

12.1.2 DC Power Supply Options for Using BT830 Module

- **Using DC power 3.3 V**
Power the on Pin-9 (VREG_IN_HV) with 3.3 V and pull-high on Pin-8 (VREG_EN_RST#) to turn on the internal regulator. The BT830 module generates 1.8 V output on Pin-10 (VREG_OUT_HV) which can supply to the other DC pin of the board.

- **Using DC power 1.8 V**
Leave the Pin-9 (VREG_IN_HV) no connection, power the Pin-10 (VREG_OUT_HV) with 1.8 V and pull-high on Pin-8 (VREG_EN_RST#) to turn on the internal regulator.

13 APPLICATION NOTE FOR SURFACE MOUNT MODULES

13.1 Introduction

Laird surface mount modules are designed to conform to all major manufacturing guidelines. This application note is intended to provide additional guidance beyond the information that is presented in the user manual. This application note is considered a living document and is updated as new information is presented.

The modules are designed to meet the needs of a number of commercial and industrial applications. They are easy to manufacture and they conform to current automated manufacturing processes.

13.2 Shipping

13.2.1 Tray Package

Modules are shipped in ESD (Electrostatic Discharge) safe trays that can be loaded into most manufacturers pick and place machines. Layouts of the trays are provided in [Error! Reference source not found.](#)

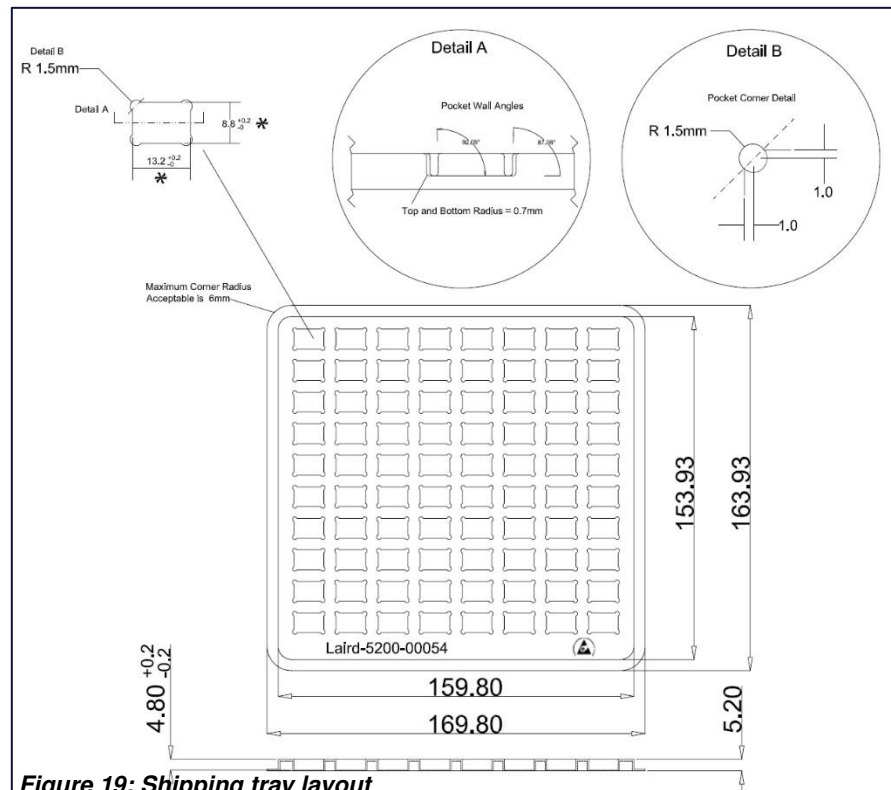

Figure 19: Shipping tray layout

13.2.2 Tape and Reel Package Information

Note: Ordering information for Tape and Reel packaging is an addition of T/R to the end of the full module part number. For example, BT830 becomes BT830-Sx-xx-T/R.

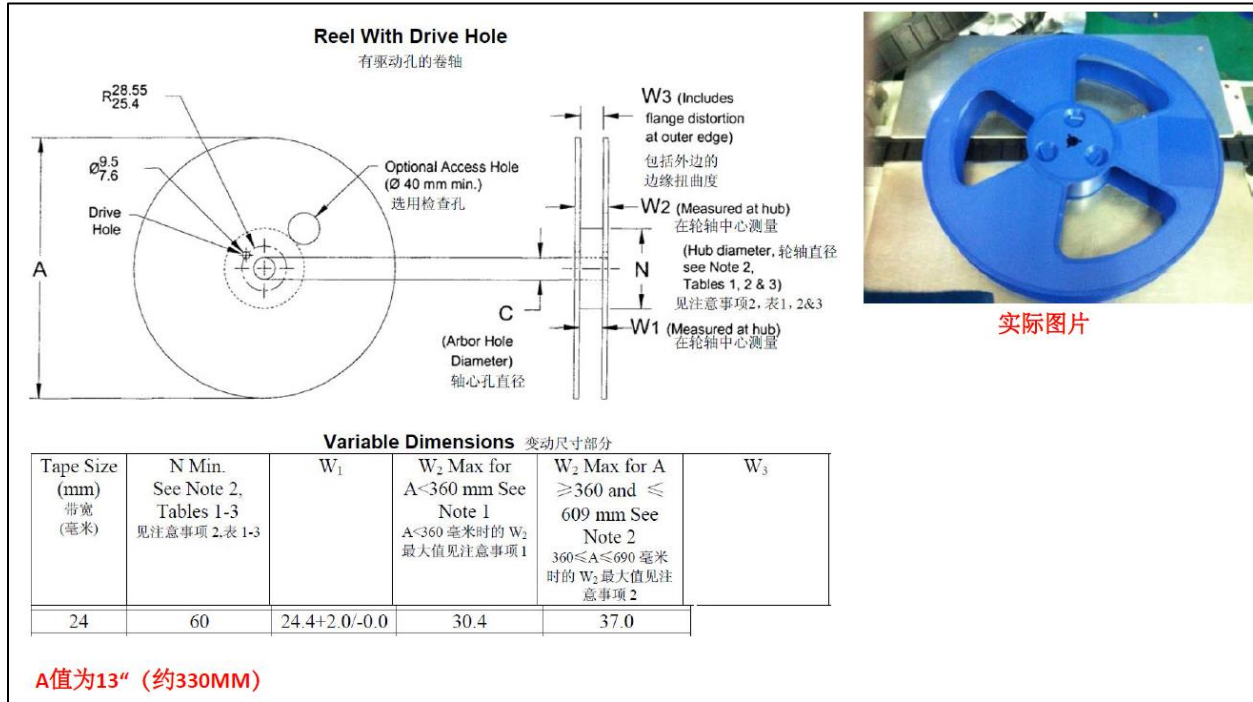

Figure 20: Reel specifications

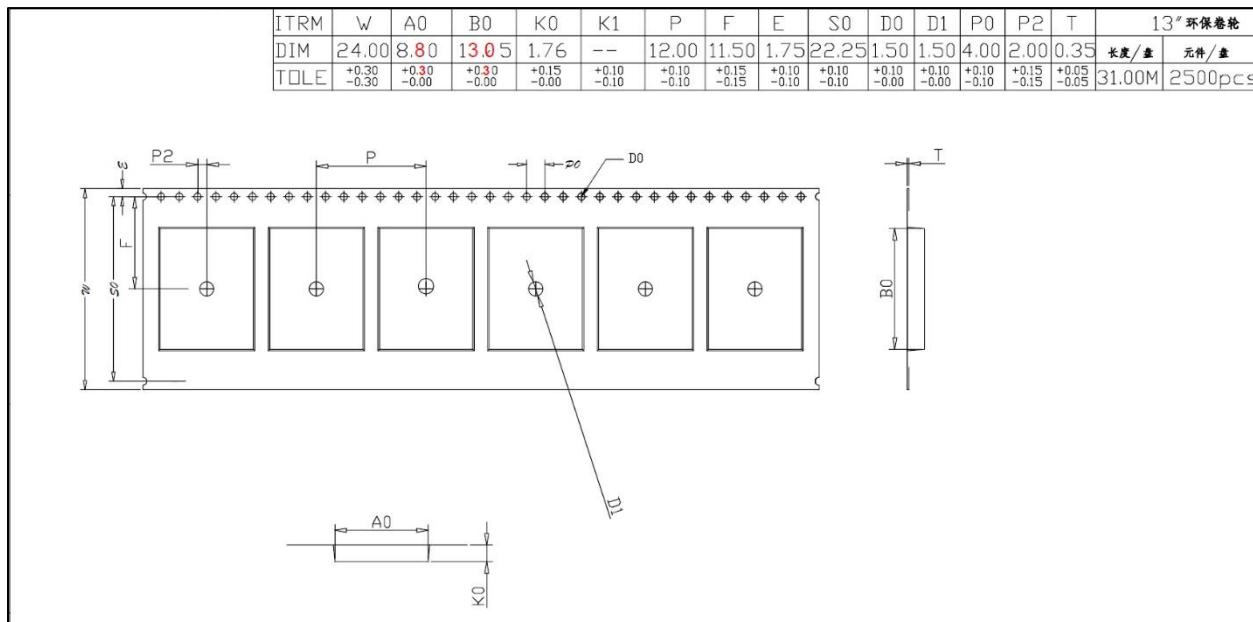

Figure 21: Tape specifications

There are 2500 BT830 modules taped in a reel (and packaged in a pizza box) and five boxes per carton (12,500 modules per carton). Reel, boxes, and carton are labeled with the appropriate labels. See Figure 22.

13.2.2.1 Packaging Process

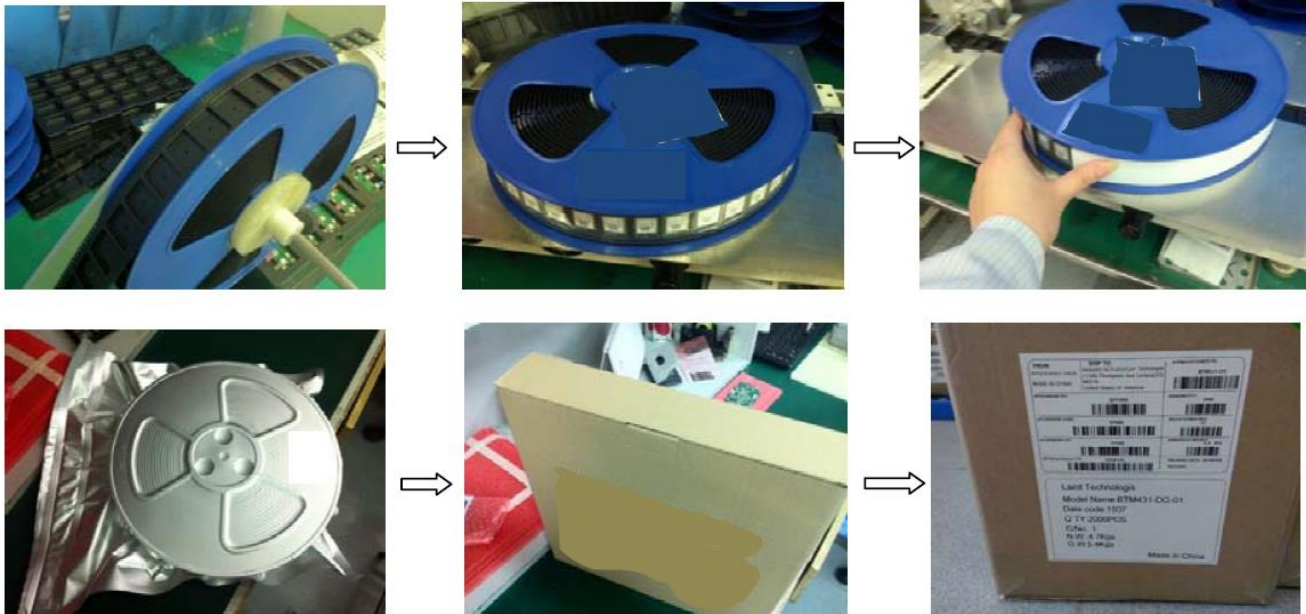

Figure 22: BT800 packaging process

13.3 Reflow Parameters

Prior to any reflow, it is important to ensure the modules were packaged to prevent moisture absorption. New packages contain desiccant (to absorb moisture) and a humidity indicator card to display the level maintained during storage and shipment. If directed to *bake units* on the card, see Table 17 and follow instructions specified by IPC/JEDEC J-STD-033. A copy of this standard is available from the JEDEC website: <http://www.jedec.org/sites/default/files/docs/jstd033b01.pdf>

Note: The shipping tray cannot be heated above 65°C. If baking is required at the higher temperatures displayed in in Table 17, the modules must be removed from the shipping tray.

Any modules not manufactured before exceeding their floor life should be re-packaged with fresh desiccant and a new humidity indicator card. Floor life for MSL (Moisture Sensitivity Level) 3 devices is 168 hours in ambient environment ≤30°C/60%RH.

Table 17: Recommended baking times and temperatures

MSL	125°C Baking Temp.		90°C/≤ 5%RH Baking Temp.		40°C/ ≤ 5%RH Baking Temp.	
	Saturated @ 30°C/85%	Floor Life Limit + 72 hours @ 30°C/60%	Saturated @ 30°C/85%	Floor Life Limit + 72 hours @ 30°C/60%	Saturated @ 30°C/85%	Floor Life Limit + 72 hours @ 30°C/60%
3	9 hours	7 hours	33 hours	23 hours	13 days	9 days

Laird surface mount modules are designed to be easily manufactured, including reflow soldering to a PCB. Ultimately it is the responsibility of the customer to choose the appropriate solder paste and to ensure oven temperatures during reflow meet the requirements of the solder paste. Laird surface mount modules conform to J-STD-020D1 standards for reflow temperatures.

Important: During reflow, modules should not be above 260° and not for more than 30 seconds.

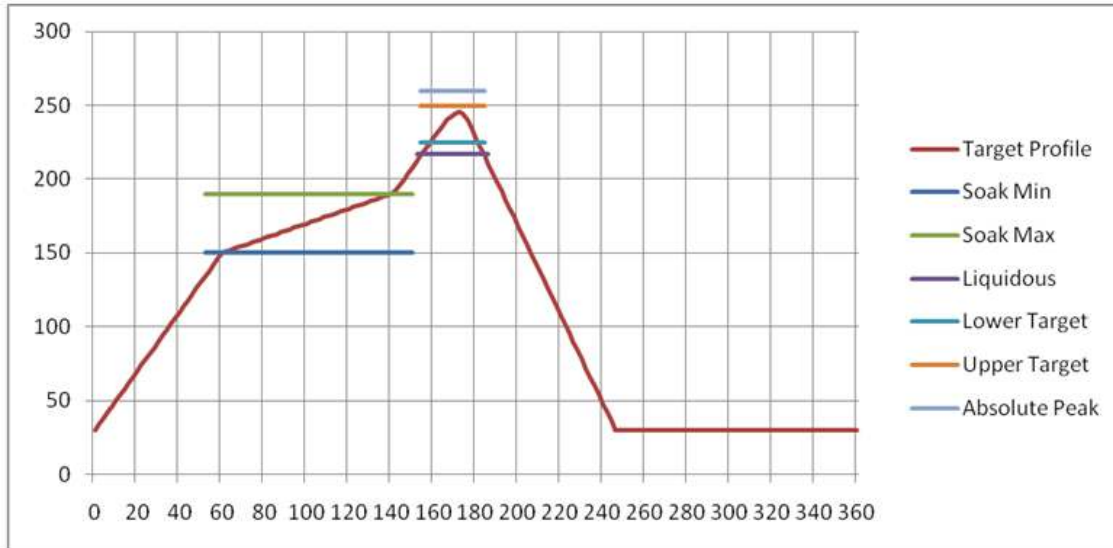

Figure 13-23: Recommended Reflow Temperature

Temperatures should not exceed the minimums or maximums presented in Table 18.

Table 18: Recommended Maximum and minimum temperatures

Specification	Value	Unit
Temperature Inc./Dec. Rate (max)	1~3	°C / Sec
Temperature Decrease rate (goal)	2-4	°C / Sec
Soak Temp Increase rate (goal)	.5 - 1	°C / Sec
Flux Soak Period (Min)	70	Sec
Flux Soak Period (Max)	120	Sec
Flux Soak Temp (Min)	150	°C
Flux Soak Temp (max)	190	°C
Time Above Liquidous (max)	70	Sec
Time Above Liquidous (min)	50	Sec
Time In Target Reflow Range (goal)	30	Sec
Time At Absolute Peak (max)	5	Sec
Liquidous Temperature (SAC305)	218	°C
Lower Target Reflow Temperature	240	°C
Upper Target Reflow Temperature	250	°C
Absolute Peak Temperature	260	°C

14 FCC AND IC REGULATORY

Model	US/FCC	CANADA/IC
BT830	SQGBT830	3147A-BT830
BT830	SQGBT830	3147A-BT830
DVK-BT830	SQGBT830	3147A-BT830

The BT830 family has been designed to operate with the antenna listed below having a maximum gain of 0.5 dBi. The required antenna impedance is 50 ohms.

Item	Model	Part Number	Mfg.	Type	Peak Gain (dBi)	Connector
1	BT830-SA	AT3216-B2R7HAA	ACX	Chip	0.5	N/A
2	BT830-ST	S181FL-L-RMM-2450S	Nearson	Dipole	2.0	UFL
3	BT830-ST	EBL2449A1-15UFL	Laird	PCB Dipole	2.0	UFL
4	BT830-ST	MAF94190	Laird	Dipole	2.0	UFL
5	BT830-ST	WRR2400-IP04-B (MAF94019)	Laird	Dipole	1.5	UFL

14.1 Documentation Requirements

In order to ensure regulatory compliance, when integrating the BT830 into a host device, it is necessary to meet the documentation requirements set forth by the applicable regulatory agencies. The following sections (FCC, Industry Canada, and European Union) outline the information that may be included in the user’s guide and external labels for the host devices into which the BT830 is integrated.

FCC

Note: You must place “Contains FCC ID: SQG-BT830” on the host product in such a location that it can be seen by an operator at the time of purchase.

User’s Guide Requirements

The BT830 complies with FCC Part 15 Rules for a Modular Approval. To leverage Laird’s grant, the conditions below must be met for the host device into which the BT830 is integrated:

- The transmitter module is not co-located with any other transmitter or antenna that is capable of simultaneous operation.

As long as the conditions above are met, further transmitter testing is typically not required. However, the OEM integrator is still responsible for testing its end-product for any additional compliance requirements required with this module installed, such as (but not limited to) digital device emissions and PC peripheral requirements.

IMPORTANT:

In the event that the conditions above cannot be met (for example certain device configurations or co-location with another transmitter), then the FCC authorization is no longer considered valid and the FCC ID cannot be used on the final product. In these circumstances, the OEM integrator will be responsible for re-evaluating the end product (including the transmitter) and obtaining a separate FCC authorization.

When using Laird’s FCC grant for the BT830, the integrator must include specific information in the user’s guide for the device into which the BT830 is integrated. The integrator must not provide information to the end user regarding how to install or remove this RF module in the user’s manual of the device into which the BT830 is integrated. The following FCC statements must be added in their entirety and without modification into a prominent place in the user’s guide for the device into which the BT830 is integrated:

IMPORTANT NOTE: To comply with FCC requirements, the BT830 must not be co-located or operating in conjunction with any other antenna or transmitter.

14.1.1.1 Federal Communication Commission Interference Statement

This equipment has been tested and found to comply with the limits for a Class B digital device, pursuant to Part 15 of the FCC Rules. These limits are designed to provide reasonable protection against harmful interference in a residential installation. This equipment generates, uses, and can radiate radio frequency energy and, if not installed and used in accordance with the instructions, may cause harmful interference to radio communications. However, there is no guarantee that interference will not occur in a particular installation. If this equipment does cause harmful interference to radio or television reception, which can be

determined by turning the equipment off and on, the user is encouraged to try to correct the interference by one of the following measures:

1. Reorient or relocate the receiving antenna.
1. Increase the separation between the equipment and receiver.
2. Connect the equipment into an outlet on a circuit different from that to which the receiver is connected.
3. Consult the dealer or an experienced radio/TV technician for help.

FCC Caution: Any changes or modifications not expressly approved by the party responsible for compliance could void the user's authority to operate this equipment.

This device complies with Part 15 of the FCC Rules. Operation is subject to the following two conditions: (1) This device may not cause harmful interference, and (2) this device must accept any interference received, including interference that may cause undesired operation.

IMPORTANT NOTE: FCC Radiation Exposure Statement:

This equipment complies with FCC radiation exposure limits set forth for an uncontrolled environment.

Industry Canada

Note: You must place "Contains IC ID: 3147A-BT830" on the host product in such a location that it can be seen by an operator at the time of purchase.

RF Radiation Hazard Warning

Using higher gain antennas and types of antennas not certified for use with this product is not allowed. The device shall not be co-located with another transmitter.

Cet avertissement de sécurité est conforme aux limites d'exposition définies par la norme CNR-102 at relative aux fréquences radio.

This radio transmitter (Contains IC ID: 3147A-BT830) has been approved by Industry Canada to operate with the antenna types listed in table above with the maximum permissible gain and required antenna impedance for each antenna type indicated. Antenna types not included in this list, having a gain greater than the maximum gain indicated for that type, are strictly prohibited for use with this device.

Le présent émetteur radio (Contains IC ID: 3147A-BT830) a été approuvé par Industrie Canada pour fonctionner avec les types d'antenne énumérés ci-dessous et ayant un gain admissible maximal et l'impédance requise pour chaque type d'antenne. Les types d'antenne non inclus dans cette liste, ou dont le gain est supérieur au gain maximal indiqué, sont strictement interdits pour l'exploitation de l'émetteur.

Under Industry Canada regulations, this radio transmitter may only operate using an antenna of a type and maximum (or lesser) gain approved for the transmitter by Industry Canada. To reduce potential radio interference to other users, the antenna type and its gain should be so chosen that the equivalent isotropically radiated power (e.i.r.p.) is not more than that necessary for successful communication.

Conformément à la réglementation d'Industrie Canada, le présent émetteur radio peut fonctionner avec une antenne d'un type et d'un gain maximal (ou inférieur) approuvé pour l'émetteur par Industrie Canada. Dans le but de réduire les risques de brouillage radioélectrique à l'intention des autres utilisateurs, il faut choisir le type d'antenne et son gain de sorte que la puissance isotrope rayonnée équivalente (p.i.r.e.) ne dépasse pas l'intensité nécessaire à l'établissement d'une communication satisfaisante.

This device complies with Industry Canada license-exempt RSS standard(s). Operation is subject to the following two conditions: (1) this device may not cause interference, and (2) this device must accept any interference, including interference that may cause undesired operation of the device.

Le présent appareil est conforme aux CNR d'Industrie Canada applicables aux appareils radio exempts de licence. L'exploitation est autorisée aux deux conditions suivantes : (1) l'appareil ne doit pas produire de brouillage, et (2) l'utilisateur de l'appareil doit accepter tout brouillage radioélectrique subi, même si le brouillage est susceptible d'en compromettre le fonctionnement.

15 EUROPEAN UNION REGULATORY

The BT830 has been tested for compliance with relevant standards for the EU market. BT830 modules were tested with a 0.5 dBi chip antenna.

The OEM should consult with a qualified test house before entering their device into an EU member country to make sure all regulatory requirements have been met for their complete device.

Reference the Declaration of Conformities listed below for a full list of the standards that the modules were tested to. Test reports are available upon request.

15.1 EU Declarations of Conformity - BT830-SA and BT830-ST

Manufacturer	Laird
Products	BT830-SA and BT830-ST
Product Description	Bluetooth v4.0 Class 1 UART HCI
EU Directives	2014/53/EU – Radio Equipment Directive (RED)

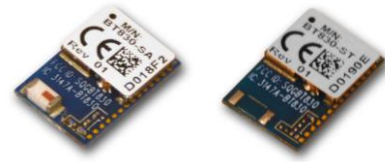

Reference standards used for presumption of conformity:

Article Number	Requirement	Reference standard(s)
3.1a	Low voltage equipment safety	EN 60950-1:2006 +A11:2009 +A1:2010 +A12:2011 +A2:2013
	RF Exposure	EN 62311:2008
		EN 62479:2010
3.1b	Protection requirements with respect to electromagnetic compatibility	EN 301 489-1 v2.2.0 (2017-03) EN 301 489-17 v3.2.0 (2017-03)
3.2	Means of the efficient use of the radio frequency spectrum (ERM)	EN 300 328 v2.1.1 (2016-11)

Declaration:

We, Laird, declare under our sole responsibility that the essential radio test suites have been carried out and that the above product to which this declaration relates is in conformity with all the applicable essential requirements of Article 3 of the EU Radio Equipment Directive 2014/53/EU, when used for its intended purpose.

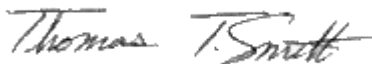
Place of Issue:	Laird W66N220 Commerce Court, Cedarburg, WI 53012 USA tel: +1-262-375-4400 fax: +1-262-364-2649
Date of Issue:	May 2017
Name of Authorized Person:	Thomas T Smith, Director of EMC Compliance
Signature of Authorized Person:	

16 JAPAN (MIC) CERTIFICATION

The BT830-SA/BT830-ST is approved for use in the Japanese market. The part numbers listed below hold WW type certification. Refer to **ARIB-STD-T66** for further guidance on OEM's responsibilities.

Item	Model	Part Number	Mfg.	Type	Peak Gain (dBi)	Connector
1	BT830-SA	AT3216-B2R7HAA	ACX	Chip	0.5	N/A
2	BT830-ST	S181FL-L-RMM-2450S	Nearson	Dipole	2.0	UFL
3	BT830-ST	EBL2449A1-15UFL	Laird	PCB Dipole	2.0	UFL
4	BT830-ST	MAF94190	Laird	Dipole	2.0	UFL
5	BT830-ST	WRR2400-IP04-B (MAF94019)	Laird	Dipole	1.5	UFL

To use our ID, the following Geteki logo and ID must be placed on your product:

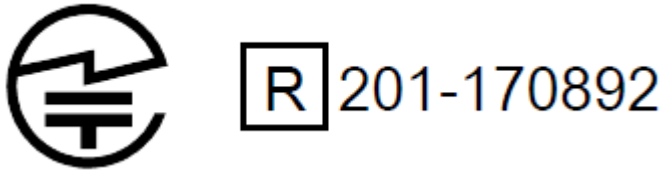

17 ORDERING INFORMATION

Part Number	Description
BT830-SA	BTv4.0 Dual Mode UART HCI Module with integrated Antenna
BT830-ST	BTv4.0 Dual Mode UART HCI Module – Trace Pin
DVK-BT830	Development Kit for BT830 Module

17.1 General Comments

This is a preliminary datasheet. Please check with Laird for the latest information before commencing a design. If in doubt, ask.

18 BLUETOOTH SIG APPROVALS

18.1 Application Note: Subsystem Combinations

This application note covers the procedure for generating a new Declaration ID for a Subsystem combination on the Bluetooth SIG website. In the instance of subsystems, a member can combine two or more subsystems to create a complete Bluetooth End Product solution.

Subsystem listings referenced as an example:

Design Name	Owner	Declaration ID	Link to listing on the SIG website
BT830	Laird	D023115	https://www.bluetooth.org/tpg/QLI_viewQDL.cfm?qid=23115
Embedded CE 6.0 (Host Subsystem)	Microsoft Corporation	B012893	https://www.bluetooth.org/tpg/QLI_viewQDL.cfm?qid=12893

18.1.1 Laird Customer Declaration ID Procedure

This procedure assumes that the member is simply combining two subsystems to create a new design, without any modification to the existing, qualified subsystems. This is achieved by using the Listing interface on the Bluetooth SIG website. Figure 24 shows the basic subsystem combination of a controller and host subsystem. The Controller provides the RF/BB/LM and HCI layers, with the Host providing L2CAP, SDP, GAP, RFCOMM/SPP and any other specific protocols and profiles existing in the Host subsystem listing. The design may also include a Profile Subsystem.

The controller provides the RF/BB/LM and HCI layers, with the Host providing L2CAP, SDP, GAP, RFCOMM/SPP and any other specific protocols and profiles existing in the Host subsystem listing. The design may also include a Profile Subsystem.

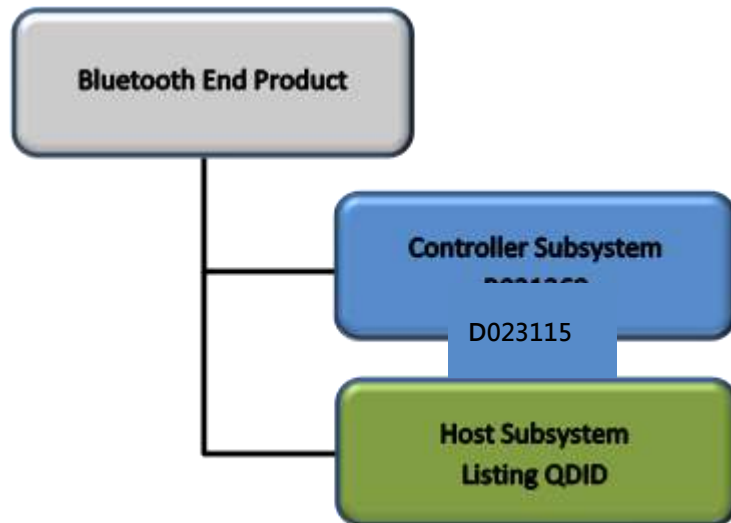

Figure 24: Basic subsystem combination of a controller and host subsystem

The Qualification Process requires each company to registered as a member of the Bluetooth SIG – <http://www.bluetooth.org>

The following link provides a link to the Bluetooth Registration page: <https://www.bluetooth.org/login/register/>

For each Bluetooth Design it is necessary to purchase a Declaration ID. This can be done before starting the new qualification, either through invoicing or credit card payment. The fees for the Declaration ID will depend on your membership status, please refer to the following webpage:

<https://www.bluetooth.org/en-us/test-qualification/qualification-overview/fees>

For a detailed procedure of how to obtain a new Declaration ID for your design, please refer to the following SIG document:

https://www.bluetooth.org/DocMan/handlers/DownloadDoc.ashx?doc_id=283698&vId=317486

To start the listing, go to: https://www.bluetooth.org/tpg/QLI_SDoc.cfm.

In step 1, select the option, **Reference a Qualified Design** and enter the Declaration IDs of each subsystem used in the End Product design. You can then select your pre-paid Declaration ID from the drop down menu or go to the Purchase Declaration ID page, (please note that unless the Declaration ID is pre-paid or purchased with a credit card, it will not be possible to proceed until the SIG invoice is paid.

Once all the relevant sections of step 1 are finished, complete steps 2, 3, and 4 as described in the help document. Your new Design will be listed on the SIG website and you can print your Certificate and DoC.

For further information please refer to the following training material:

<https://www.bluetooth.org/en-us/test-qualification/qualification-overview/listing-process-updates>