

1744037-6 ✓ ACTIVE



Economy Power

TE Internal #: 1744037-6

Rectangular Power Connectors, Header, Plug, Wire-to-Board, 6 Position, 5.08 mm [.2 in] Centerline, Printed Circuit Board, UL 94V-0, Economy Power

[View on TE.com >](#)

Connectors > Power Connectors > Rectangular Power > Rectangular Power Connectors

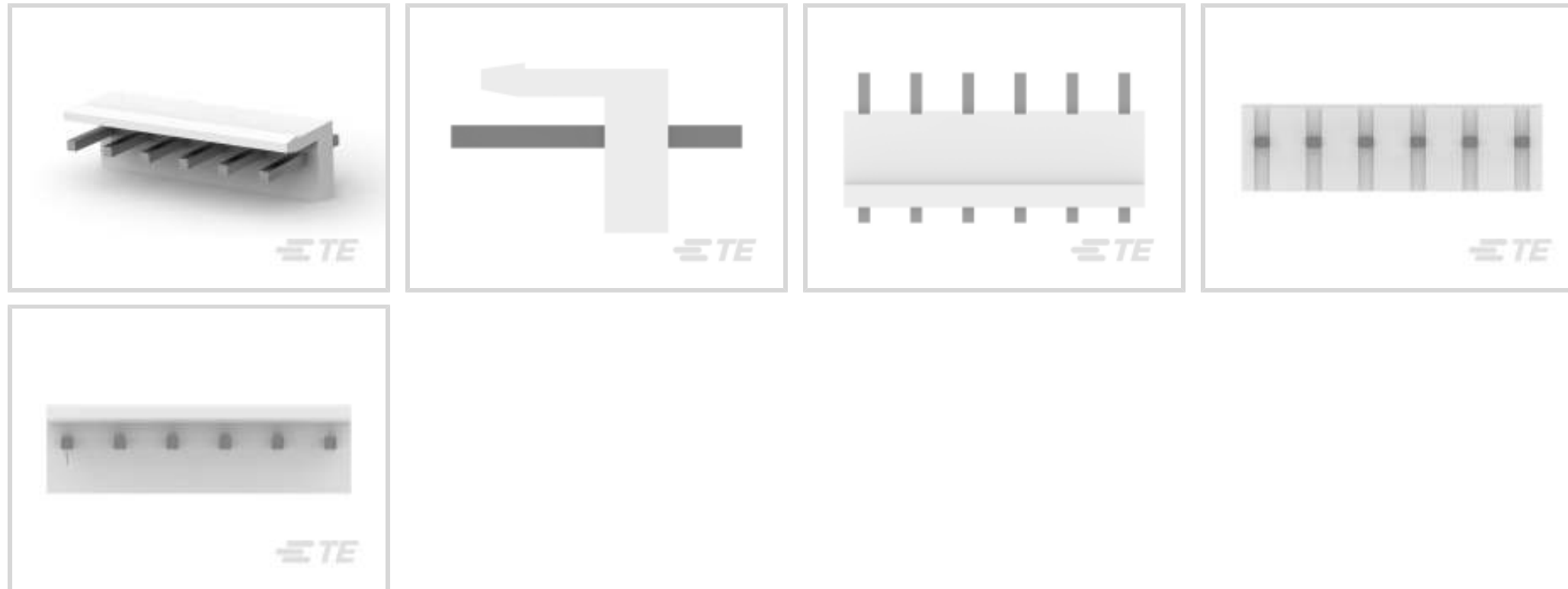

Rectangular Power Connector Type: **Header**

Connector & Housing Type: **Plug**

Connector System: **Wire-to-Board**

Number of Positions: **6**

Centerline (Pitch): **5.08 mm [.2 in]**

Features

Product Type Features

Header Type	Partially Shrouded
Rectangular Power Connector Type	Header
Connector & Housing Type	Plug
Connector System	Wire-to-Board
Sealable	No
Connector & Contact Terminates To	Printed Circuit Board

Configuration Features

Number of Positions	6
PCB Mount Orientation	Vertical
Number of Power Positions	6
Number of Rows	1

Electrical Characteristics

Operating Voltage	250 VDC
-------------------	---------

Contact Features



PCB Contact Termination Area Plating Material Thickness	.8 μm , 1 μm [31.49 μin][39.37 μin]
Contact Layout	Inline
Contact Mating Area Plating Material	Tin
Contact Base Material	Copper Alloy
Contact Current Rating (Max)	8 A
Contact Retention Within Housing	Without
Contact Type	Pin
PCB Contact Termination Area Plating Material	Tin
Contact Mating Area Plating Material Thickness	2.03 μm [80 μin]

Termination Features

Termination Post & Tail Length	3.7 mm[.146 in]
Termination Method to Printed Circuit Board	Through Hole - Solder

Mechanical Attachment

Strain Relief	Without
Mating Retention	With
Mating Alignment	With
PCB Mount Alignment	Without
Panel Mount Feature	Without
PCB Mount Retention	Without
Mating Retention Type	Latch
Connector Mounting Type	Board Mount

Housing Features

Centerline (Pitch)	5.08 mm[.2 in]
Housing Color	Natural
Housing Material	Nylon 66

Dimensions

Connector Height	10.9 mm[.429 in]
PCB Thickness (Recommended)	.06 mm[1.6 in]
Product Width	8.2 mm[.323 in]
Product Length	28 mm[1.102 in]

Usage Conditions

Operating Temperature Range	-25 – 105 $^{\circ}\text{C}$ [-13 – 221 $^{\circ}\text{F}$]
-----------------------------	--



Operation/Application

Circuit Application	Power
---------------------	-------

Industry Standards

UL Flammability Rating	UL 94V-0
Glow Wire Rating	Standard Part - Not Glow Wire

Packaging Features

Packaging Quantity	500
Packaging Method	Bag

Product Compliance

[For compliance documentation, visit the product page on TE.com>](#)

EU RoHS Directive 2011/65/EU	Compliant
EU ELV Directive 2000/53/EC	Compliant
China RoHS 2 Directive MIIT Order No 32, 2016	No Restricted Materials Above Threshold
EU REACH Regulation (EC) No. 1907/2006	Current ECHA Candidate List: JUNE 2023 (235) Candidate List Declared Against: JUNE 2023 (235) Does not contain REACH SVHC
Halogen Content	Low Halogen - Br, Cl, F, I < 900 ppm per homogenous material. Also BFR/CFR/PVC Free
Solder Process Capability	Wave solder capable to 240°C

Product Compliance Disclaimer

This information is provided based on reasonable inquiry of our suppliers and represents our current actual knowledge based on the information they provided. This information is subject to change. The part numbers that TE has identified as EU RoHS compliant have a maximum concentration of 0.1% by weight in homogenous materials for lead, hexavalent chromium, mercury, PBB, PBDE, DBP, BBP, DEHP, DIBP, and 0.01% for cadmium, or qualify for an exemption to these limits as defined in the Annexes of Directive 2011/65/EU (RoHS2). Finished electrical and electronic equipment products will be CE marked as required by Directive 2011/65/EU. Components may not be CE marked. Additionally, the part numbers that TE has identified as EU ELV compliant have a maximum concentration of 0.1% by weight in homogenous materials for lead, hexavalent chromium, and mercury, and 0.01% for cadmium, or qualify for an exemption to these limits as defined in the Annexes of Directive 2000/53/EC (ELV). Regarding the REACH Regulation, the information TE provides on SVHC in articles for this part number is based on the latest European Chemicals Agency (ECHA) 'Guidance on requirements for substances in articles' posted at this URL: <https://echa.europa.eu/guidance-documents/guidance-on-reach>

Compatible Parts



Also in the Series | Economy Power

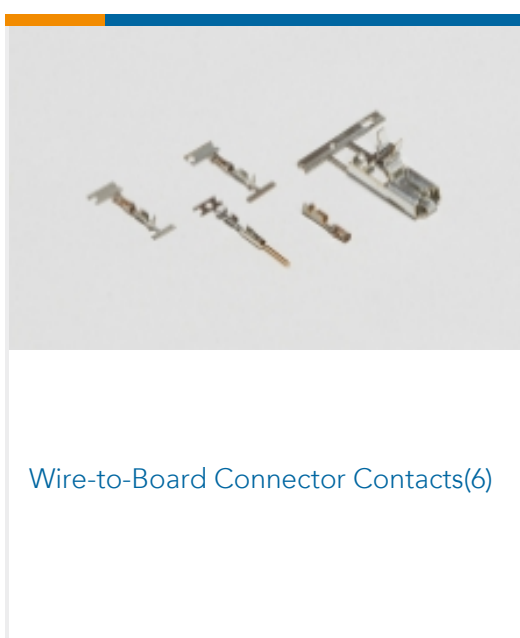
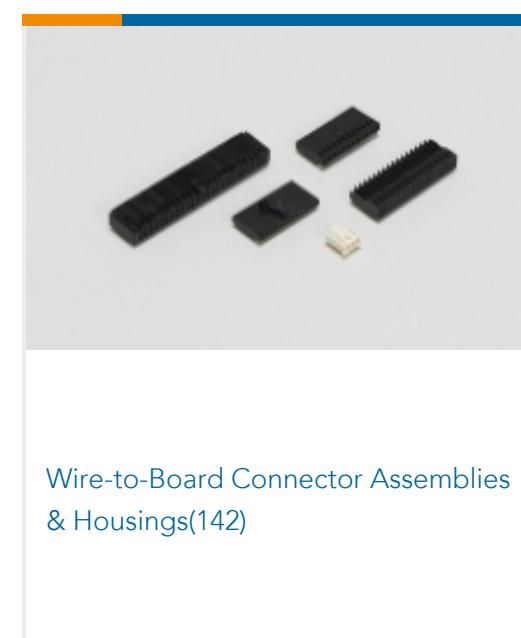
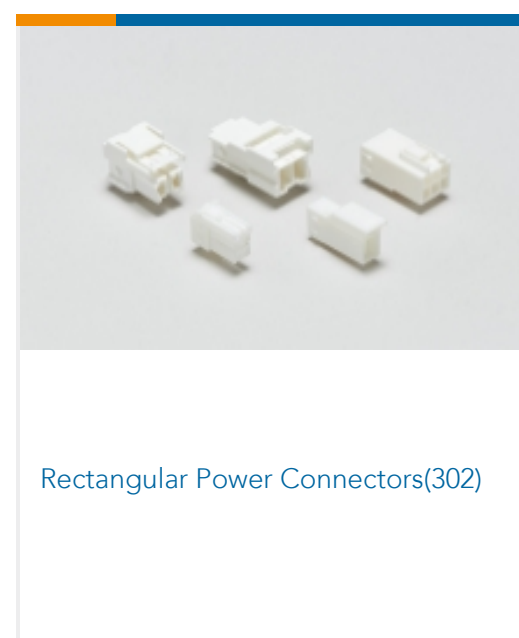
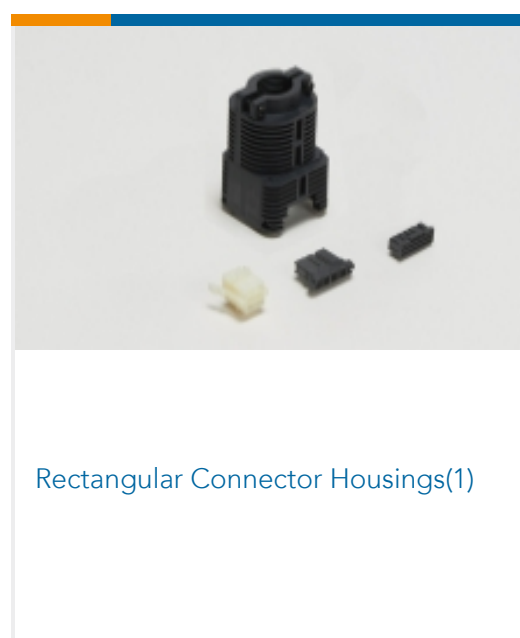
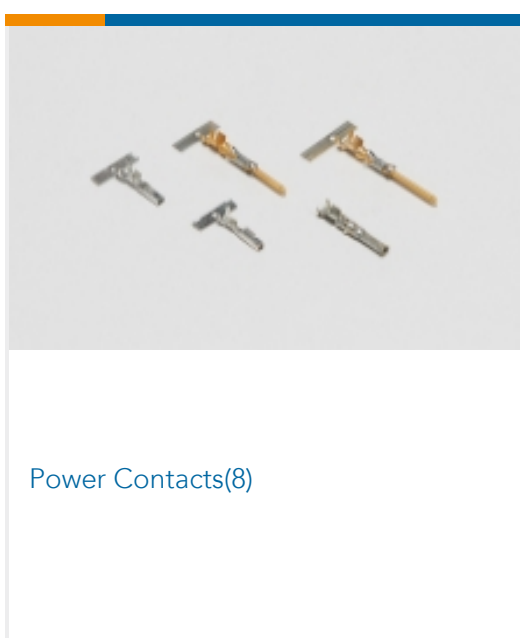
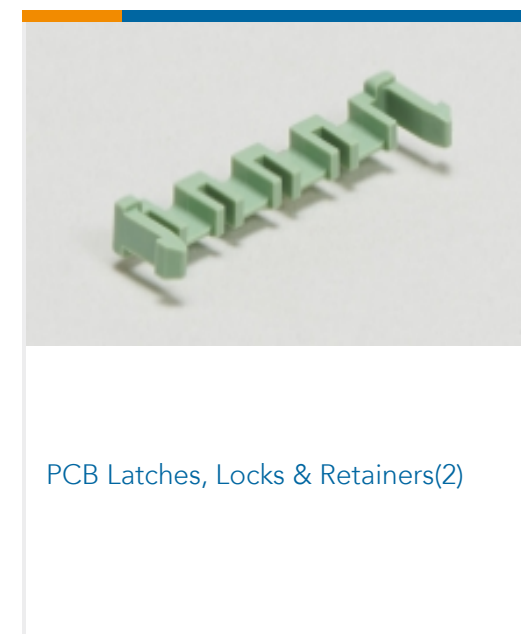
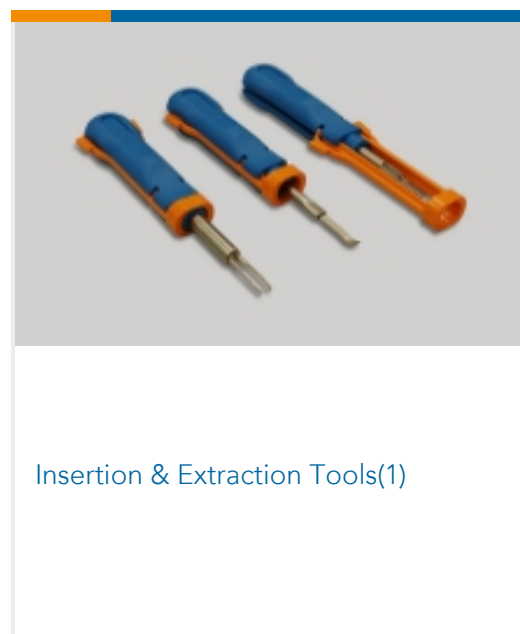
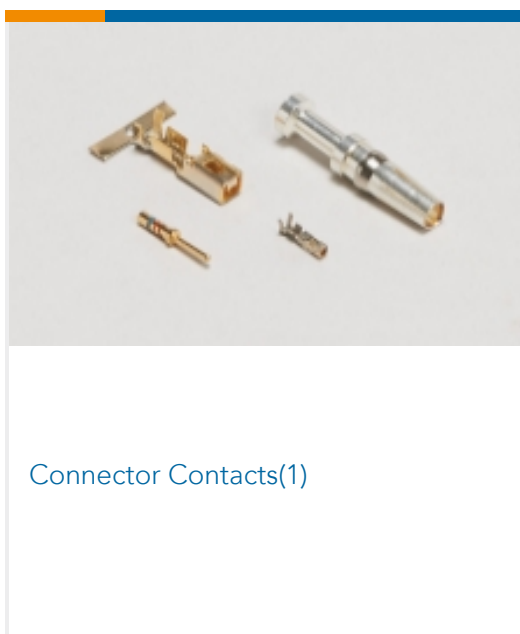

Customers Also Bought

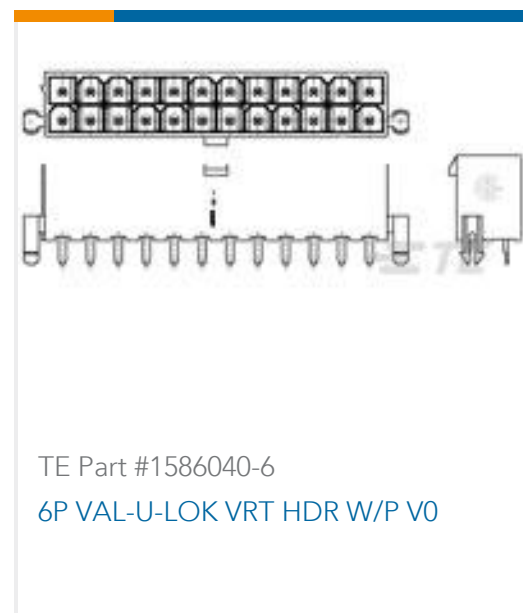
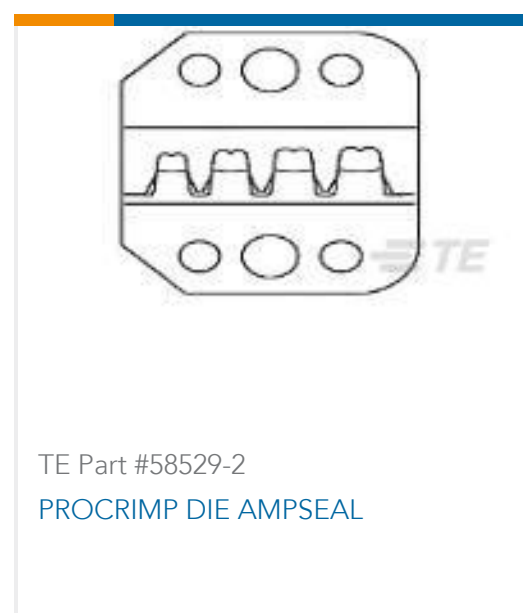

Documents

Product Drawings

[06P EC PWR.200 CL HDR ASSY VRT](#)

English

CAD Files

[3D PDF](#)

3D

Customer View Model

[ENG_CVM_CVM_1744037-6_O.2d_dxf.zip](#)

English

Customer View Model

[ENG_CVM_CVM_1744037-6_O.3d_igs.zip](#)

English

Customer View Model

[ENG_CVM_CVM_1744037-6_O.3d_stp.zip](#)

English

By downloading the CAD file I accept and agree to the [Terms and Conditions](#) of use.

Datasheets & Catalog Pages



1-1773885-9 Economy Power Connectors

English

Product Specifications

Application Specification

English

Application Specification

Japanese

Product Environmental Compliance

MD_1744037-6_041720172348_dmtec

English

MD_1744037-6_041720172348_dmtec

English

Agency Approvals

UL Report

English