

THIS DRAWING IS UNPUBLISHED.
 VERTRÄULICHE UNVERÖFFENTLICHTE ZEICHNUNG
 © COPYRIGHT 20 BY -
 RELEASED FOR PUBLICATION
 FREI FÜR VERÖFFENTLICHUNG
 ALL RIGHTS RESERVED.
 ALLE RECHTE VORBEHALTEN.
 MATED WITH:
 PASSEND ZU:

PROJEKT NR.:		REVISIONS ÄNDERUNGEN			
P	LTR	DESCRIPTION BESCHREIBUNG	DATE	DWN	APVD
E		ECR-14-013059	02SEP2014	ABV	SA
E1		ECR-15-015157	20OCT2015	ABV	SA

Kodierungen
CODINGS
2:1

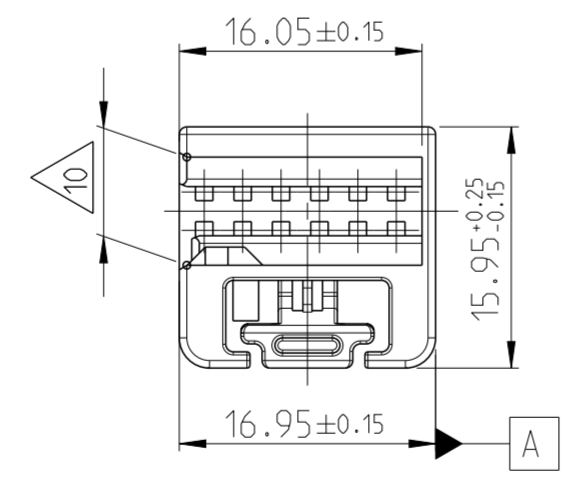
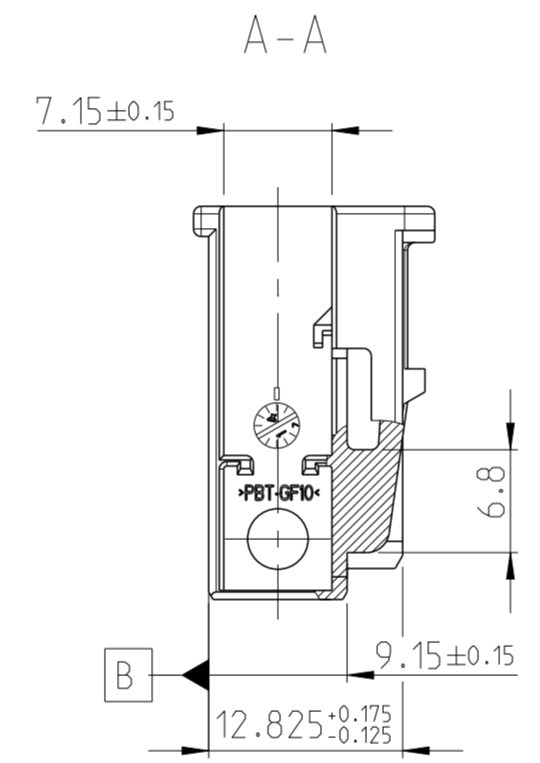
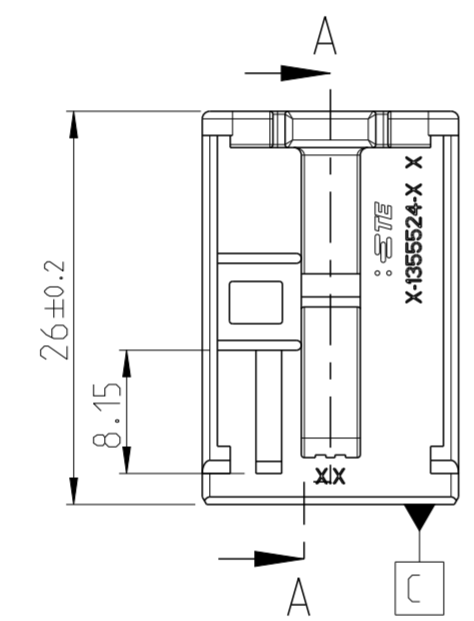
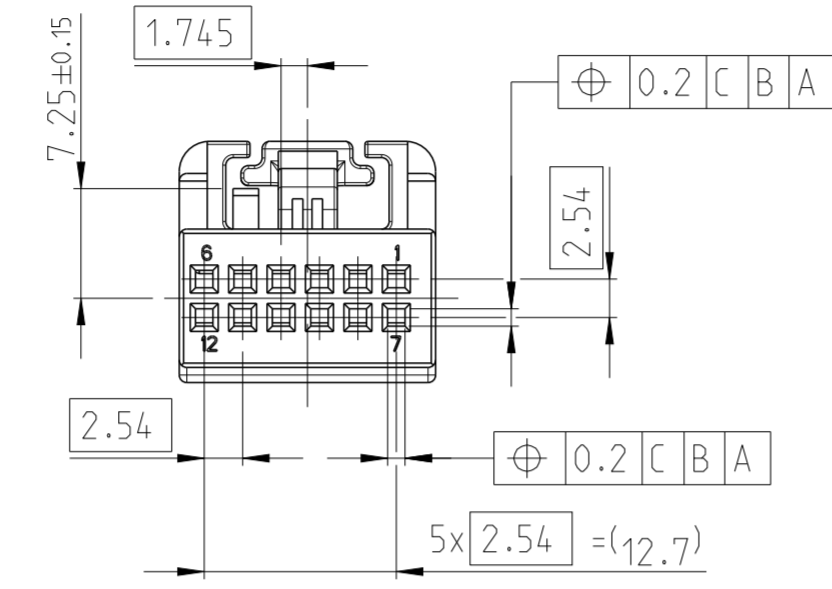
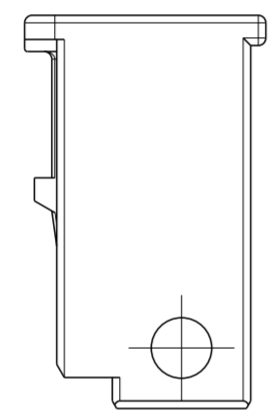
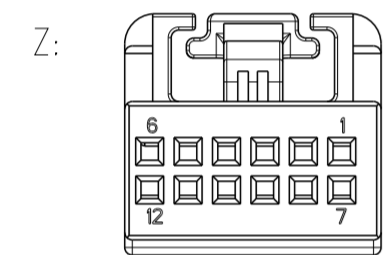
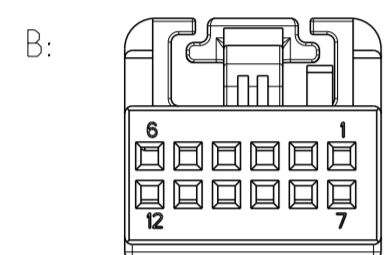
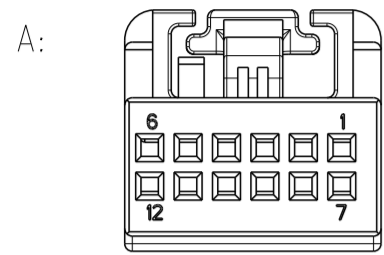

Bemerkungen
NOTES

- Passend zu Buchsengehäuse, siehe Zeichnung TE: 1394048
SUITABLE TO SOCKET HOUSING. SEE DRAWING
 - Änderung nur mit Zustimmung der freigebenden Fachabteilung
CHANGES ONLY WITH APPROVAL OF THE RESPONSIBLE DEPARTMENT
 - Einzelheiten der Ausführung bleiben dem Hersteller überlassen
THE MANUFACTURER CAN CHANGE DETAILS OF THE DESIGN
 - Massgebend ist der deutsche Text
ONLY THE GERMAN-LANGUAGE VERSION SHALL BE BINDING
 - Formteilungsgrad zulaessig
PART LINE PERMITTED MAX. 0.3
 - Formteilungsversatz zulaessig
SPLIT LINE PERMITTED MAX. 0.3
 - Verpackung: Schuetztgut
PACKAGING: LOOSE PIECE
 - Zulaessiger Regeneratanteil
RECYCLED MATERIAL PERMISSIBLE MAX. 25%
 - Ausfuehrung Lieferantenlogo wahlweise
SUPPLIER LOGO VERSION OPTIONAL
 - Verzug zulaessig bis max. ±0.5 mm
WARPAGE PERMITTED TO MAX. ±0.5 mm (E1)
- 1- -3 wie gezeichnet
AS SHOWN

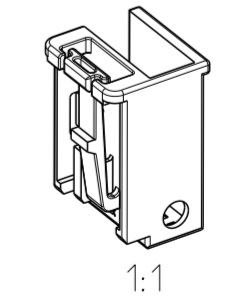

9-1355524-3	E	Z	Abdeckkappe/COVER	wasserblau/WATER BLUE	S	2.3	1241768-2 1241768-1
2-1355524-3	E	B	Abdeckkappe/COVER	natur/NATURAL	S	2.3	
1-1355524-3	E	A	Abdeckkappe/COVER	schwarz/BLACK	S	2.3	
TE BESTELL-NR. ORDER NO.	REV.	KOD. COD.	BENENNUNG DESCRIPTION	OBERFLAECHE SURFACE FARBE/COLOUR	ART KIND GEWICHT WEIGHT	GRAMM	Passend zu: SUITABLE FOR: Stiftwanne PIN HEADER

TOLERANCING ISO 8015 TOLERIERUNG ISO 8015		TOLERANCES UNLESS OTHERWISE SPECIFIED ACC. TO DIN 16901-140⑩⑪⑫⑬⑭⑮⑯⑰⑱⑲⑳㉑㉒㉓㉔㉕㉖㉗㉘㉙㉚㉛㉜㉝㉞㉟㊱㊲㊳㊴㊵㊶㊷㊸㊹㊺㊻㊼㊽㊾㊿	
DIESE ZEICHNUNG IST EIN KONTROLLIERTES DOKUMENT. BEMASSUNGEN UND TOLERANZEN GEMAESS GPS (ISO STANDARDS).		THIS DRAWING IS A CONTROLLED DOCUMENT. DIMENSIONING AND TOLERANCING PER GPS (ISO STANDARDS).	
DIMENSIONS: MASSEINHEITEN: (MM)		TOLERANCES UNLESS OTHERWISE SPECIFIED: ALLGEMEINTOLERANZEN	
MATERIAL PBT-GF10		MATERIAL PBT-GF10	
DWN Q.Patschula CHK J.Hahn		DATE 20JUL99	
APVD -		NAME -	
PRODUCT SPEC 108-18157		APPLICATION SPEC 114-18351	
WEIGHT -		SCALE 2:1	
CUSTOMER DRAWING		/KUNDENZEICHNUNG	
SIZE A2		DRAWING NO. ZEICHNUNGS-NR. C-1355524	
RESTRICTED TO NUR FUER -		SHEET BLATT 1 OF 1	
REV E1		SCALE MASSSTAB 2:1	