

PMC 8518 series PoL Regulators
 Input 8.3 -16 V, Output up to 10 A / 50 W

2/28701-BMR 619 Rev.A November 2017

© Flex

Key Features

- 33.00x13.46x 8.25 mm (1.30 x 0.530 x 0.335in.)
- Up to 16A output current
- 8.3-16 V input voltage range
- Output voltages from 0.75V up to 5.5V
- More than 5 million hours MTBF

General Characteristics

- Operating temperature: -45°C to 115°C
- Output short-circuit protection
- Under voltage protection
- Remote sense
- Remote control
- Highly automated manufacturing ensures quality
- ISO 9001/14001 certified supplier

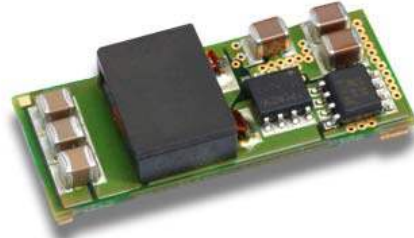

Safety Approvals



Design for Environment



Meets requirements in high-temperature lead-free soldering processes.

Contents

General Information	2
Safety Specification	3
Absolute Maximum Ratings	4
Product Program	Ordering No.
1.0-5.0 V, 10 A / 50W	PMC 8518T S
1.0 V, 10 A / 10W Electrical Specification	5
1.2 V, 10 A / 12W Electrical Specification	8
1.5 V, 10 A / 15W Electrical Specification	11
1.8 V, 10 A / 18W Electrical Specification	14
2.5 V, 10 A / 25W Electrical Specification	17
3.3 V, 10 A / 33W Electrical Specification	20
5.0 V, 10 A / 50W Electrical Specification	23
EMC Specification	26
Operating Information	26
Thermal Consideration	29
Connections	30
Mechanical Information	31
Soldering Information	32
Delivery Information	33
Product Qualification Specification	34

PMC 8518 series PoL Regulators
Input 8.3 -16 V, Output up to 10 A / 50 W

2/28701-BMR 619 Rev.A November 2017

© Flex

General Information

Ordering Information

See Contents for individual product ordering numbers.

Option	Suffix	Ordering No.
Negative Remote Control Logic	N	PMC 8518T SN

Reliability

The Mean Time Between Failure (MTBF) is calculated at full output power and an operating ambient temperature (T_A) of +40°C, which is a typical condition in Information and Communication Technology (ICT) equipment. Different methods could be used to calculate the predicted MTBF and failure rate which may give different results. Ericsson Power Modules currently uses Telcordia SR332.

Predicted MTBF for the series is:

- 5 million hours according to Telcordia SR332, issue 1, Black box technique.

Telcordia SR332 is a commonly used standard method intended for reliability calculations in ICT equipment. The parts count procedure used in this method was originally modelled on the methods from MIL-HDBK-217F, Reliability Predictions of Electronic Equipment. It assumes that no reliability data is available on the actual units and devices for which the predictions are to be made, i.e. all predictions are based on generic reliability parameters.

Compatibility with RoHS requirements

The products are compatible with the relevant clauses and requirements of the RoHS directive 2011/65/EU and have a maximum concentration value of 0.1% by weight in homogeneous materials for lead, mercury, hexavalent chromium, PBB and PBDE and of 0.01% by weight in homogeneous materials for cadmium.

Exemptions in the RoHS directive utilized in Flex products are found in the Statement of Compliance document.

Flex fulfills and will continuously fulfill all its obligations under regulation (EC) No 1907/2006 concerning the registration, evaluation, authorization and restriction of chemicals (REACH) as they enter into force and is through product materials declarations preparing for the obligations to communicate information on substances in the products.

Quality Statement

The products are designed and manufactured in an industrial environment where quality systems and methods like ISO 9000, Six Sigma, and SPC are intensively in use to boost the continuous improvements strategy. Infant mortality or early failures in the products are screened out and they are subjected to an ATE-based final test. Conservative design rules, design reviews and product qualifications, plus the high competence of an engaged work force, contribute to the high quality of the products.

Warranty

Warranty period and conditions are defined in Flex General Terms and Conditions of Sale.

Limitation of Liability

Flex does not make any other warranties, expressed or implied including any warranty of merchantability or fitness for a particular purpose (including, but not limited to, use in life support applications, where malfunctions of product can cause injury to a person's health or life).

© Flex 2017

The information and specifications in this technical specification is believed to be correct at the time of publication. However, no liability is accepted for inaccuracies, printing errors or for any consequences thereof. Flex reserves the right to change the contents of this technical specification at any time without prior notice.

PMC 8518 series PoL Regulators Input 8.3 -16 V, Output up to 10 A / 50 W	2/28701-BMR 619 Rev.A November 2017
	© Flex

Safety Specification

General information

Flex DC/DC converters and DC/DC regulators are designed in accordance with the safety standards IEC 62368-1, EN 62368-1 and UL 62368-1 *Audio/video, information and communication technology equipment - Part 1: Safety requirements*

IEC/EN/UL 62368-1 contains requirements to prevent injury or damage due to the following hazards:

- Electrical shock
- Electrically-caused fire
- Injury caused by hazardous substances
- Mechanically-caused injury
- Skin burn
- Radiation-caused injury

On-board DC/DC converters, Power interface modules and DC/DC regulators are defined as component power supplies. As components they cannot fully comply with the provisions of any safety requirements without “conditions of acceptability”. Clearance between conductors and between conductive parts of the component power supply and conductors on the board in the final product must meet the applicable safety requirements. Certain conditions of acceptability apply for component power supplies with limited stand-off (see Mechanical Information for further information). It is the responsibility of the installer to ensure that the final product housing these components complies with the requirements of all applicable safety standards and regulations for the final product.

Component power supplies for general use shall comply with the requirements in IEC/EN/UL 62368-1. Product related standards, e.g. IEEE 802.3af *Power over Ethernet*, and ETS-300132-2 *Power interface at the input to telecom equipment, operated by direct current (dc)* are based on IEC/EN/UL 60950-1 with regards to safety.

Flex DC/DC converters, Power interface modules and DC/DC regulators are UL 62368-1 recognized and certified in accordance with EN 62368-1. The flammability rating for all construction parts of the products meet requirements for V-0 class material according to IEC 60695-11-10, *Fire hazard testing, test flames – 50 W horizontal and vertical flame test methods*.

Non-isolated DC/DC regulators

The input voltage to the DC/DC regulator is SELV (Safety Extra Low Voltage) and the output remains SELV under normal and abnormal operating conditions.

PMC 8518 series PoL Regulators
 Input 8.3 -16 V, Output up to 10 A / 50 W

2/28701-BMR 619 Rev.A November 2017
 © Flex

Absolute Maximum Ratings

Characteristics		min	typ	max	Unit
T _{ref}	Operating Temperature (see Thermal Consideration section)	-45		115	°C
T _s	Storage temperature	-40		125	°C
V _I	Input voltage	8.3	12.0	16	V
V _{RC}	Remote Control pin voltage (see Operating Information section)	Positive logic option		16	V
		Negative logic option	-0.3	0.3	V
V _{adj}	Adjust pin voltage (see Operating Information section)	N/A		N/A	V

Stress in excess of Absolute Maximum Ratings may cause permanent damage. Absolute Maximum Ratings, sometimes referred to as no destruction limits, are normally tested with one parameter at a time exceeding the limits of Output data or Electrical Characteristics. If exposed to stress above these limits, function and performance may degrade in an unspecified manner.

Fundamental Circuit Diagram

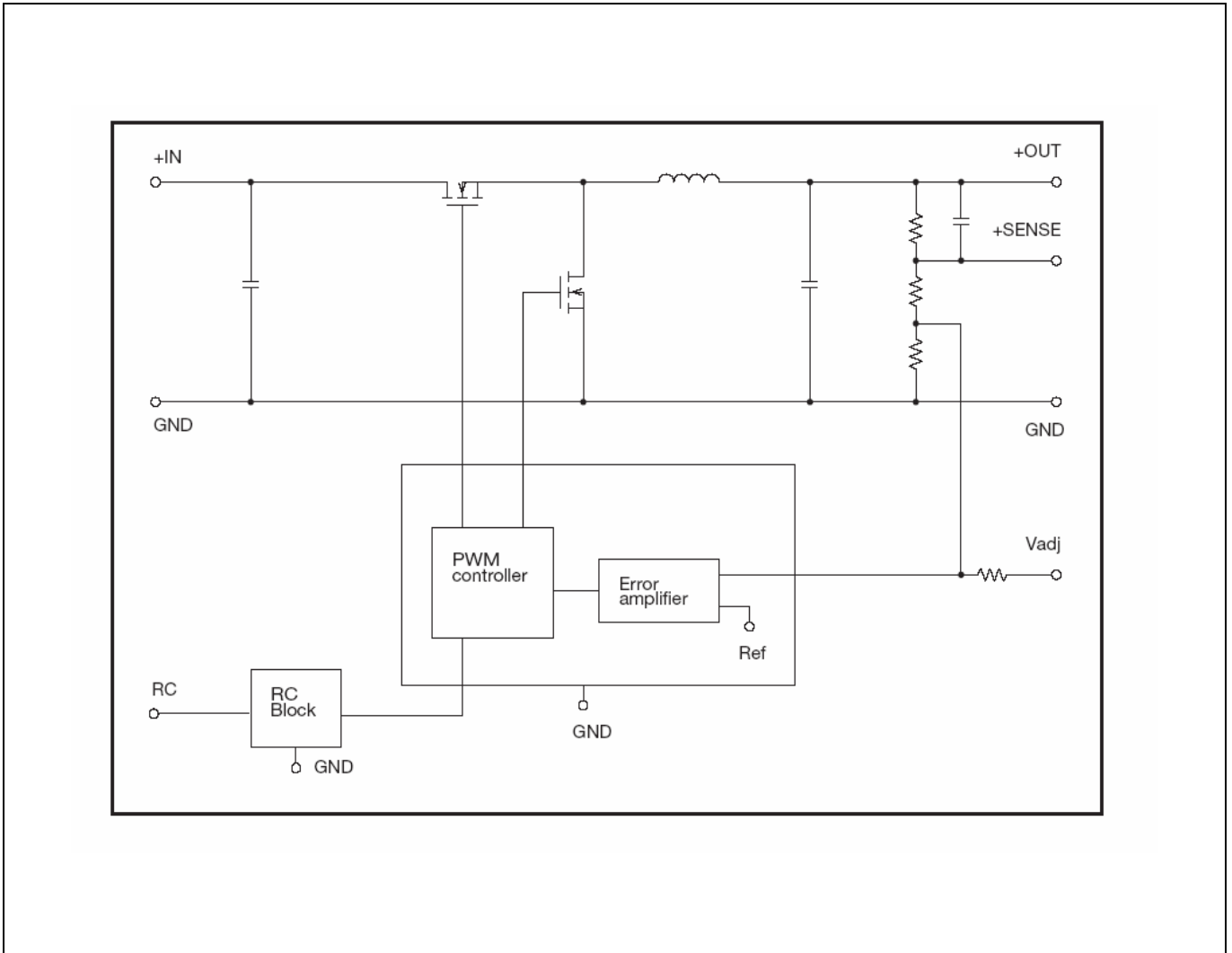

PMC 8518 series PoL Regulators
 Input 8.3 -16 V, Output up to 10 A / 50 W

2/28701-BMR 619 Rev.A November 2017

© Flex

1.0 V/10 A Electrical Specification**PMC 8518T S**
 $T_{ref} = -40$ to $+85^{\circ}\text{C}$, $V_I = 8.3$ to 16 V, $R_{adj} = 41.42$ k Ω , unless otherwise specified under Conditions.

 Typical values given at: $T_{ref} = +25^{\circ}\text{C}$, $V_I = 12$ V, max I_O , unless otherwise specified under Conditions.

 Additional $C_{in} = 4 \times 4.7$ μF and $C_{out} = 2 \times 150$ μF . See Operating Information section for selection of capacitor types.

Connect the sense pin, where available, to the output pin.

Characteristics		Conditions	min	typ	max	Unit
V_I	Input voltage range		8.3		16	V
V_{loff}	Turn-off input voltage	Decreasing input voltage		7.8		V
V_{lon}	Turn-on input voltage	Increasing input voltage		8.0		V
C_I	Internal input capacitance			30		μF
P_O	Output power		0		10	W
η	Efficiency	50 % of max I_O		83.5		%
		max I_O		84.2		
P_d	Power Dissipation	max I_O		1.9	2.2	W
P_{li}	Input idling power	$I_O = 0$ A, $V_I = 12.0$ V		0.5		W
P_{RC}	Input standby power	$V_I = 12.0$ V (turned off with RC)		35		mW
I_S	Static Input current	$V_I = 12.0$ V, max I_O		1.0		A
f_s	Switching frequency	0-100 % of max I_O	260	300	340	kHz

V_{Oi}	Output voltage initial setting and accuracy	$T_{ref} = +25^{\circ}\text{C}$, $V_I = 12.0$ V, max I_O	-2		+2	%V
V_O	Output voltage tolerance band	10-100 % of max I_O	-3		+3	%V
	Idling voltage	$I_O = 0$ A	-2		+2	%V
	Line regulation	max I_O		2		mV
	Load regulation	$V_I = 12.0$ V, 0-100 % of max I_O		10		mV
V_{tr}	Load transient voltage deviation	$V_I = 12.0$ V, Load step 25-75-25 % of max I_O , $di/dt = 5$ A/ μs		± 100		mV
t_{tr}	Load transient recovery time			40		μs
t_r	Ramp-up time (from 10-90 % of V_O)	max I_O		3		ms
t_s	Start-up time (from V_I connection to 90 % of V_O)			7		ms
t_f	V_I shut-down fall time. (From V_I off to 10 % of V_O)	Max I_O		1		ms
		$I_O = 0$ A		22		s
t_{RC} t_{inh}	RC start-up time	Max I_O		7		ms
	RC shut-down fall time (From RC off to 10 % of V_O)	Max I_O		1		ms
		$I_O = 0$ A		24		s
I_O	Output current		0		10	A
I_{lim}	Current limit threshold	$T_{ref} < \text{max } T_{ref}$	20	23		A
I_{sc}	Short circuit current	$T_{ref} = 25^{\circ}\text{C}$, See Operating Information section.		24	25	A
V_{Oac}	Output ripple & noise	See ripple & noise section, max I_O		35	70	mVp-p

PMC 8518 series PoL Regulators
 Input 8.3 -16 V, Output up to 10 A / 50 W

2/28701-BMR 619 Rev.A November 2017
 © Flex

1.0 V/10 A Typical Characteristics

PMC 8518T S

Efficiency

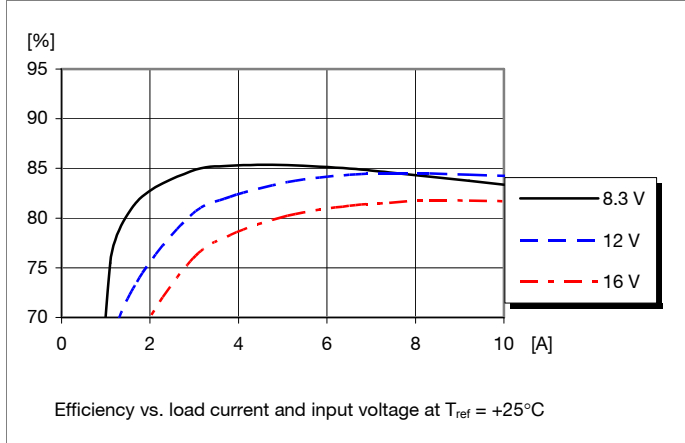

Power Dissipation

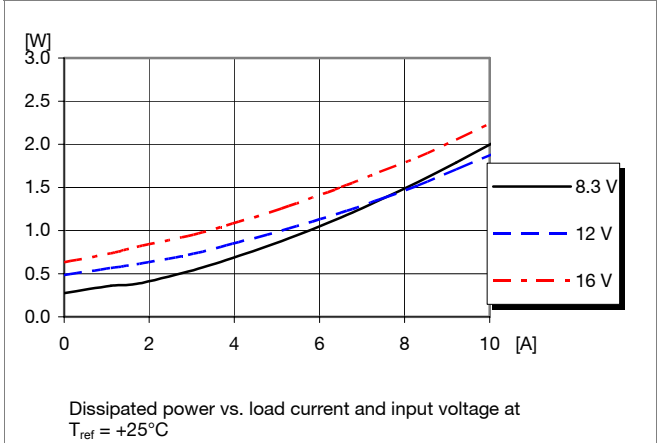

Output Current Derating

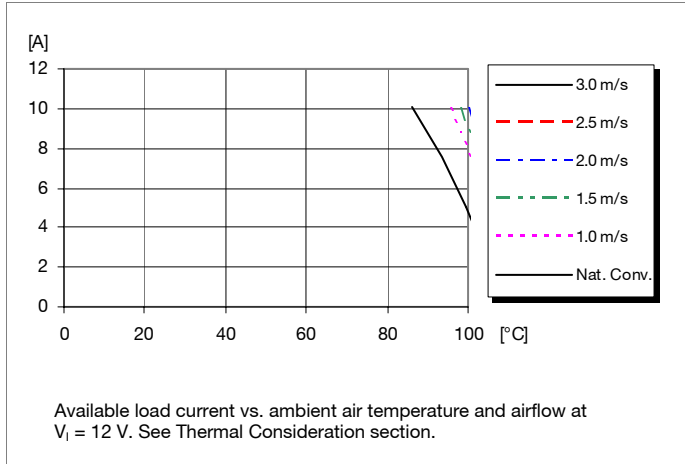

Thermal Resistance

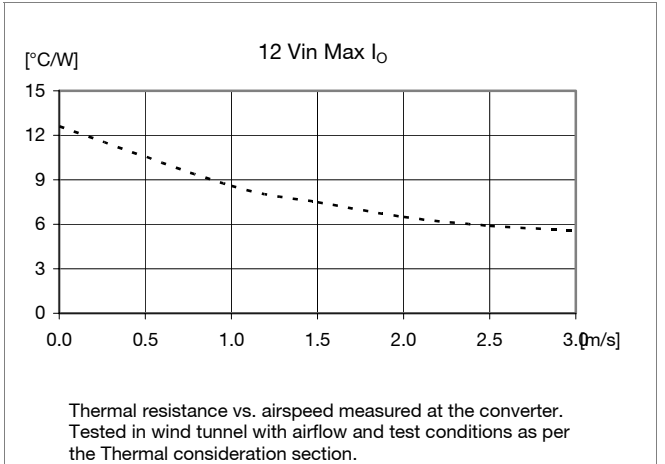

Output Characteristics

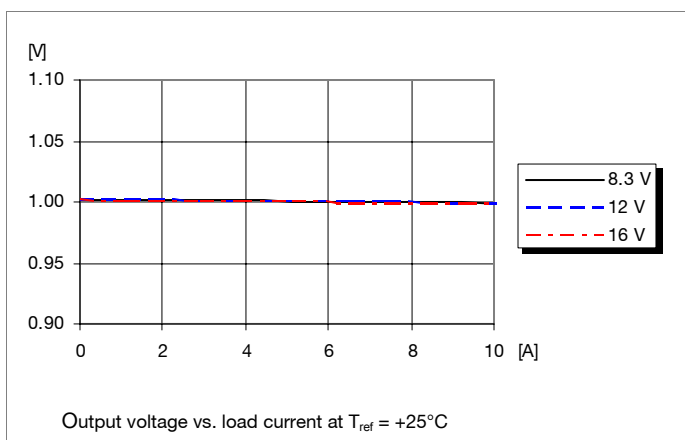

Current Limit Characteristics

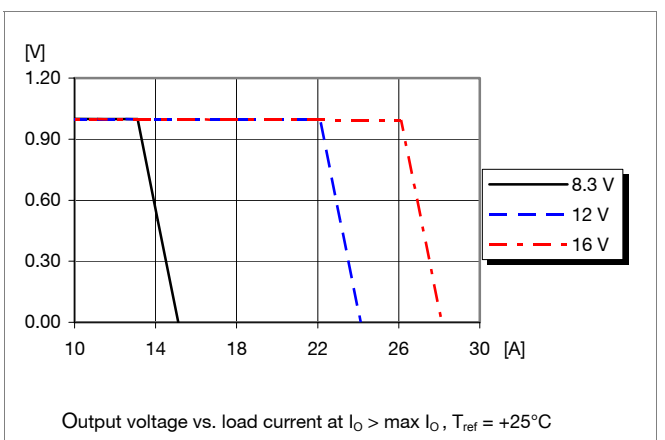

PMC 8518 series PoL Regulators
 Input 8.3 -16 V, Output up to 10 A / 50 W

2/28701-BMR 619 Rev.A November 2017
 © Flex

1.0 V/10 A Typical Characteristics

PMC 8518T S

Start-up

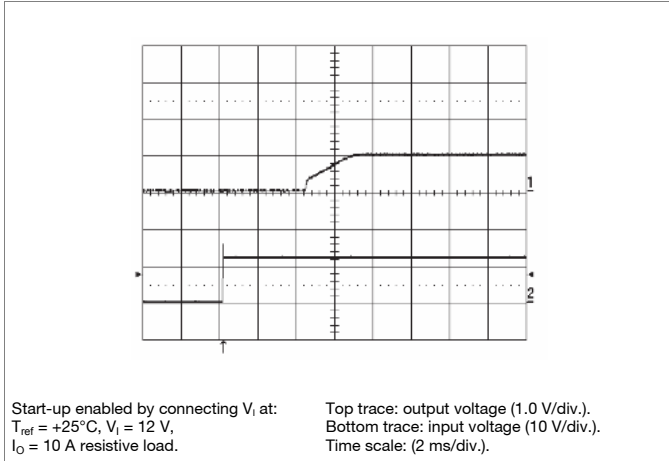

Shut-down

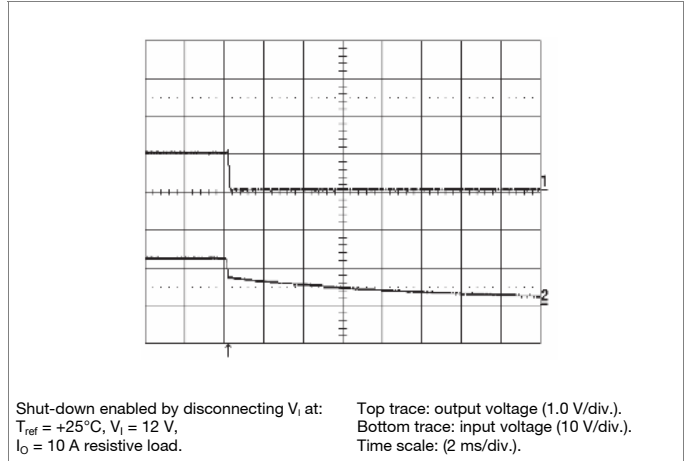

Output Ripple & Noise

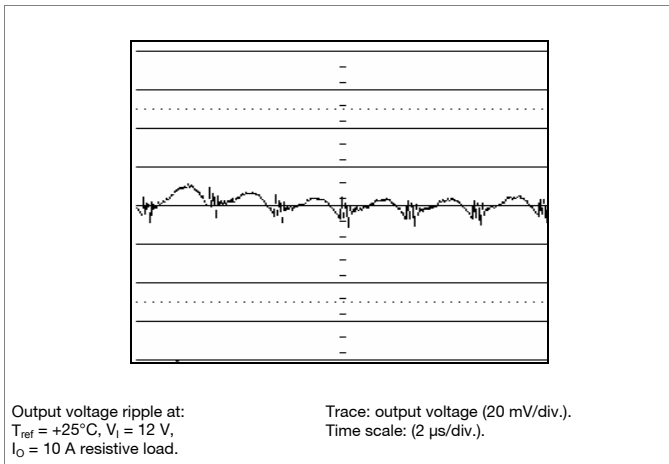

Output Load Transient Response

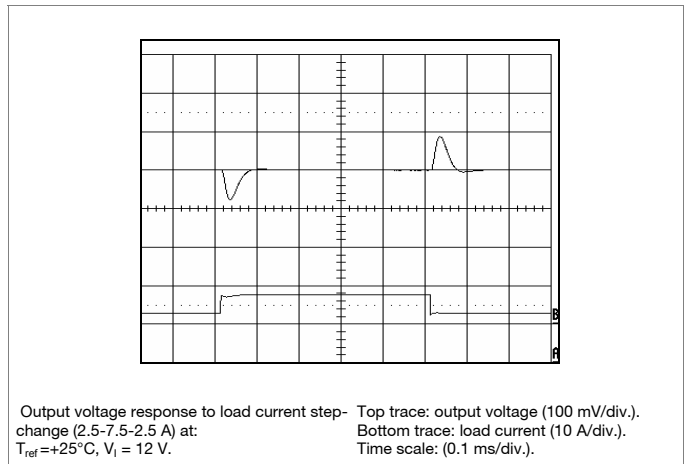

Output Voltage Adjust (see operating information)

PMC 8518 series PoL Regulators
 Input 8.3 -16 V, Output up to 10 A / 50 W

2/28701-BMR 619 Rev.A November 2017

© Flex

1.2 V/10 A Electrical Specification
PMC 8518T S
 $T_{ref} = -40$ to $+85^{\circ}\text{C}$, $V_I = 8.3$ to 16 V, $R_{adj} = 22.46$ k Ω , unless otherwise specified under Conditions.

 Typical values given at: $T_{ref} = +25^{\circ}\text{C}$, $V_I = 12$ V, max I_O , unless otherwise specified under Conditions.

 Additional $C_{in} = 4 \times 4.7$ μF and $C_{out} = 2 \times 150$ μF . See Operating Information section for selection of capacitor types.

Connect the sense pin, where available, to the output pin.

Characteristics		Conditions	min	typ	max	Unit
V_I	Input voltage range		8.3		16	V
V_{loff}	Turn-off input voltage	Decreasing input voltage		7.8		V
V_{lon}	Turn-on input voltage	Increasing input voltage		8.0		V
C_I	Internal input capacitance			30		μF
P_O	Output power		0		12	W
η	Efficiency	50 % of max I_O		85.6		%
		max I_O		86.3		
P_d	Power Dissipation	max I_O		1.9	2.2	W
P_{li}	Input idling power	$I_O = 0$ A, $V_I = 12.0$ V		0.5		W
P_{RC}	Input standby power	$V_I = 12.0$ V (turned off with RC)		35		mW
I_S	Static Input current	$V_I = 12.0$ V, max I_O		1.2		A
f_s	Switching frequency	0-100 % of max I_O	260	300	340	kHz

V_{Oi}	Output voltage initial setting and accuracy	$T_{ref} = +25^{\circ}\text{C}$, $V_I = 12.0$ V, max I_O	-2		+2	%V
V_O	Output voltage tolerance band	10-100 % of max I_O	-3		+3	%V
	Idling voltage	$I_O = 0$ A	-2		+2	%V
	Line regulation	max I_O		2		mV
	Load regulation	$V_I = 12.0$ V, 0-100 % of max I_O		10		mV
V_{tr}	Load transient voltage deviation	$V_I = 12.0$ V, Load step 25-75-25 % of max I_O , $di/dt = 5$ A/ μs		± 100		mV
t_{tr}	Load transient recovery time			40		μs
t_r	Ramp-up time (from 10–90 % of V_O)	max I_O		3		ms
t_s	Start-up time (from V_I connection to 90 % of V_O)			7		ms
t_f	V_I shut-down fall time. (From V_I off to 10 % of V_O)	Max I_O		1		ms
		$I_O = 0$ A		21		s
t_{RC} t_{inh}	RC start-up time	Max I_O		7		ms
	RC shut-down fall time (From RC off to 10 % of V_O)	Max I_O		1		ms
		$I_O = 0$ A		21		s
I_O	Output current		0		10	A
I_{lim}	Current limit threshold	$T_{ref} < \max T_{ref}$	19	22		A
I_{sc}	Short circuit current	$T_{ref} = 25^{\circ}\text{C}$, See Operating Information section.		22	24	A
V_{Oac}	Output ripple & noise	See ripple & noise section, max I_O		35	70	mVp-p

PMC 8518 series PoL Regulators
 Input 8.3 -16 V, Output up to 10 A / 50 W

2/28701-BMR 619 Rev.A November 2017
 © Flex

1.2 V/10 A Typical Characteristics

PMC 8518T S

Efficiency

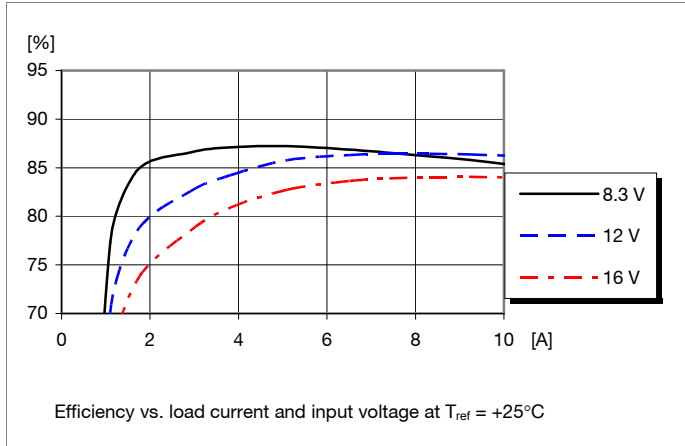

Power Dissipation

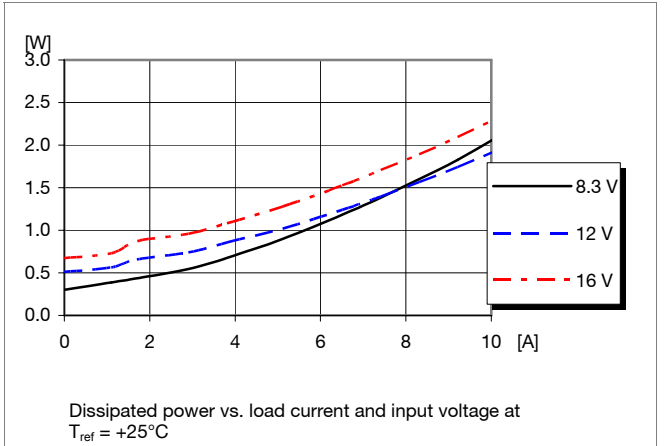

Output Current Derating

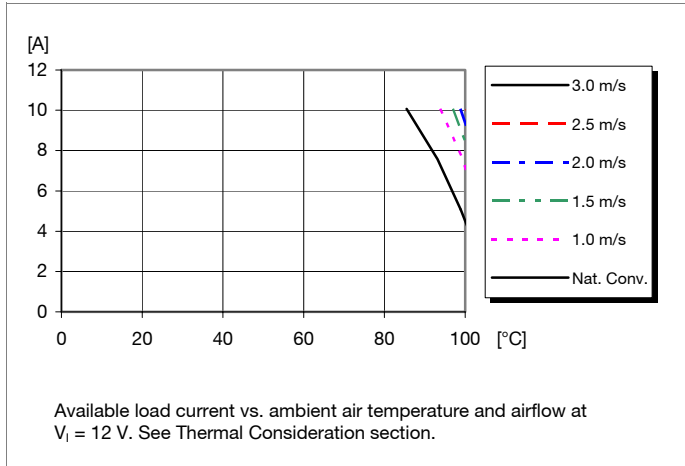

Thermal Resistance

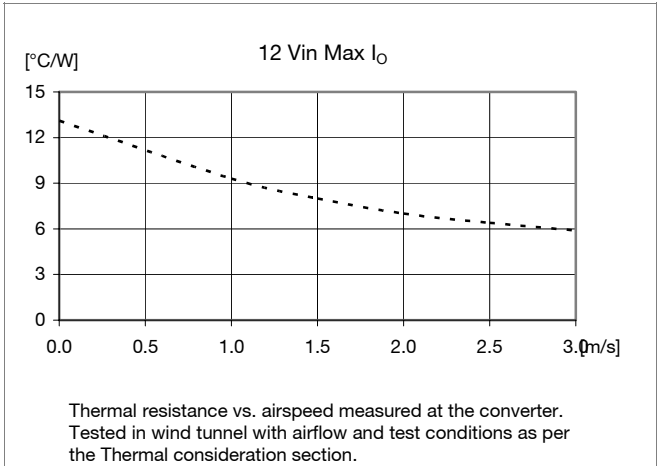

Output Characteristics

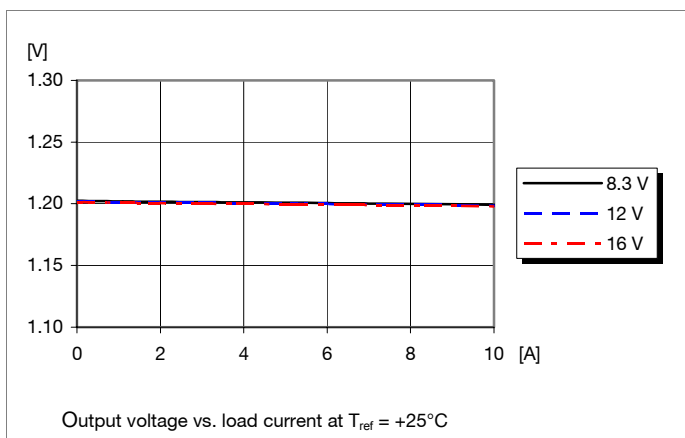

Current Limit Characteristics

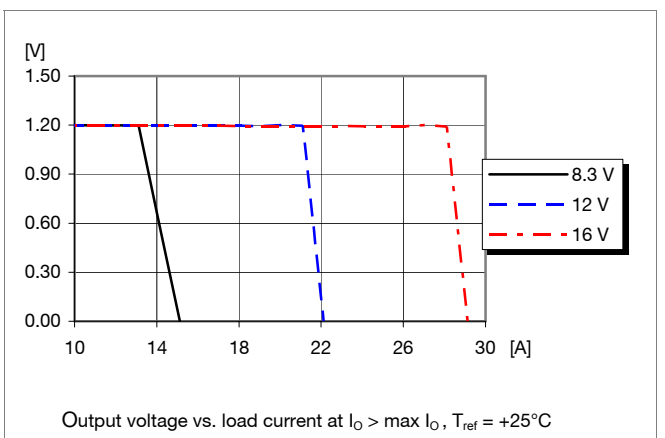

PMC 8518 series PoL Regulators
 Input 8.3 -16 V, Output up to 10 A / 50 W

2/28701-BMR 619 Rev.A November 2017
 © Flex

1.2 V/10 A Typical Characteristics

PMC 8518T S

Start-up

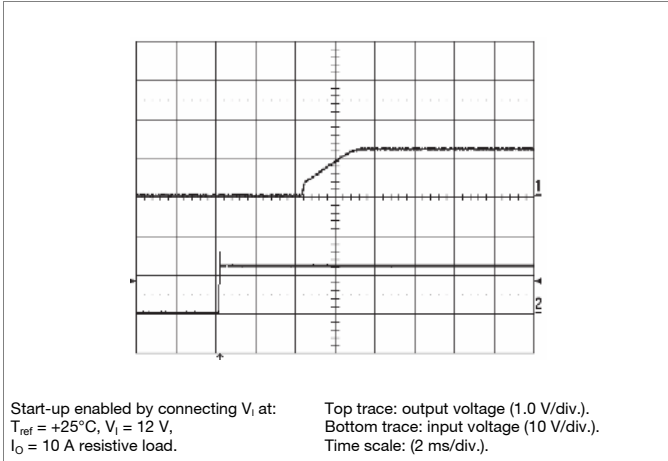

Shut-down

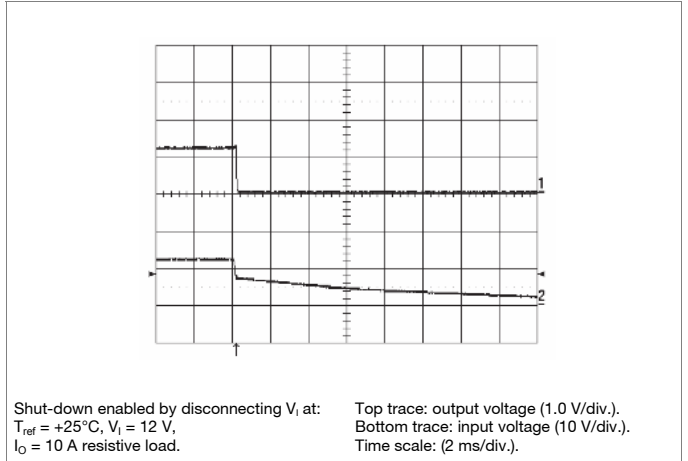

Output Ripple & Noise

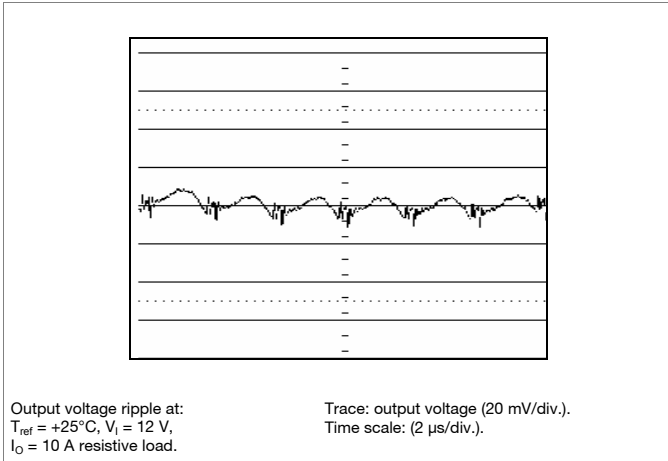

Output Load Transient Response

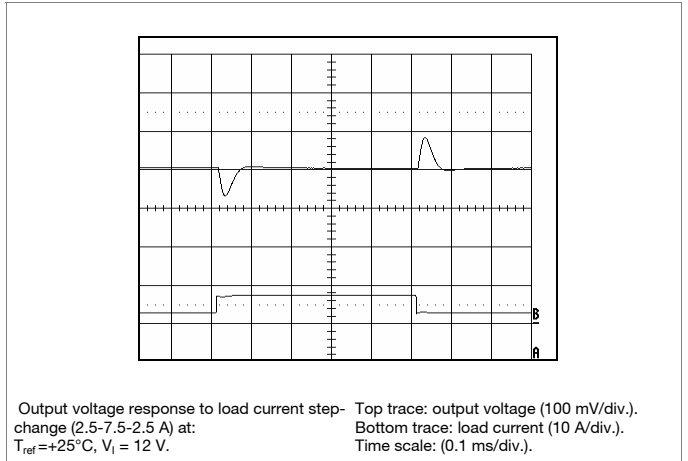

Output Voltage Adjust (see operating information)

PMC 8518 series PoL Regulators
 Input 8.3 -16 V, Output up to 10 A / 50 W

2/28701-BMR 619 Rev.A November 2017

© Flex

1.5 V/10 A Electrical Specification
PMC 8518T S
 $T_{ref} = -40$ to $+85^{\circ}\text{C}$, $V_I = 8.3$ to 16 V, $R_{adj} = 13.05$ k Ω , unless otherwise specified under Conditions.

 Typical values given at: $T_{ref} = +25^{\circ}\text{C}$, $V_I = 12$ V, max I_O , unless otherwise specified under Conditions.

 Additional $C_{in} = 4 \times 4.7$ μF and $C_{out} = 2 \times 150$ μF . See Operating Information section for selection of capacitor types.

Connect the sense pin, where available, to the output pin.

Characteristics		Conditions	min	typ	max	Unit
V_I	Input voltage range		8.3		16	V
V_{loff}	Turn-off input voltage	Decreasing input voltage		7.8		V
V_{lon}	Turn-on input voltage	Increasing input voltage		8.0		V
C_I	Internal input capacitance			30		μF
P_O	Output power		0		15	W
η	Efficiency	50 % of max I_O		87.7		%
		max I_O		88.3		
P_d	Power Dissipation	max I_O		2.0	2.3	W
P_{li}	Input idling power	$I_O = 0$ A, $V_I = 12.0$ V		0.6		W
P_{RC}	Input standby power	$V_I = 12.0$ V (turned off with RC)		35		mW
I_S	Static Input current	$V_I = 12.0$ V, max I_O		1.4		A
f_s	Switching frequency	0-100 % of max I_O	260	300	340	kHz

V_{Oi}	Output voltage initial setting and accuracy	$T_{ref} = +25^{\circ}\text{C}$, $V_I = 12.0$ V, max I_O	-2		+2	%V
V_O	Output voltage tolerance band	10-100 % of max I_O	-3		+3	%V
	Idling voltage	$I_O = 0$ A	-2		+2	%V
	Line regulation	max I_O		2		mV
	Load regulation	$V_I = 12.0$ V, 0-100 % of max I_O		10		mV
V_{tr}	Load transient voltage deviation	$V_I = 12.0$ V, Load step 25-75-25 % of max I_O , $di/dt = 5$ A/ μs		± 100		mV
t_{tr}	Load transient recovery time			40		μs
t_r	Ramp-up time (from 10–90 % of V_O)	max I_O		3		ms
t_s	Start-up time (from V_I connection to 90 % of V_O)			7		ms
t_f	V_I shut-down fall time. (From V_I off to 10 % of V_O)	Max I_O		1		ms
		$I_O = 0$ A		20		s
t_{RC} t_{inh}	RC start-up time	Max I_O		7		ms
	RC shut-down fall time (From RC off to 10 % of V_O)	Max I_O		1		ms
		$I_O = 0$ A		20		s
I_O	Output current		0		10	A
I_{lim}	Current limit threshold	$T_{ref} < \max T_{ref}$	13	19		A
I_{sc}	Short circuit current	$T_{ref} = 25^{\circ}\text{C}$, See Operating Information section.		19	21	A
V_{Oac}	Output ripple & noise	See ripple & noise section, max I_O		35	70	mVp-p

PMC 8518 series PoL Regulators
 Input 8.3 -16 V, Output up to 10 A / 50 W

2/28701-BMR 619 Rev.A November 2017
 © Flex

1.5 V/10 A Typical Characteristics

PMC 8518T S

Efficiency

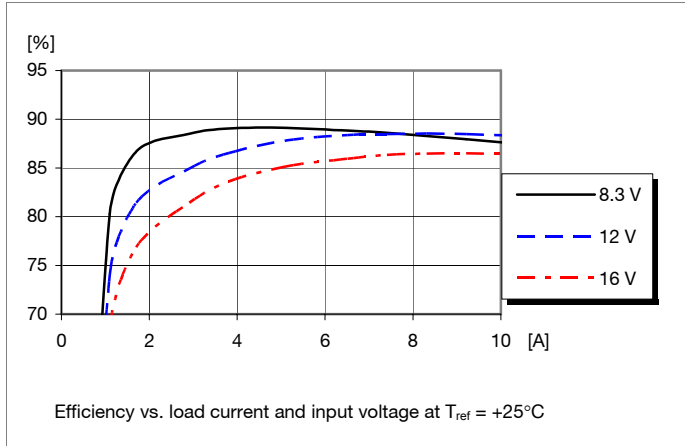

Power Dissipation

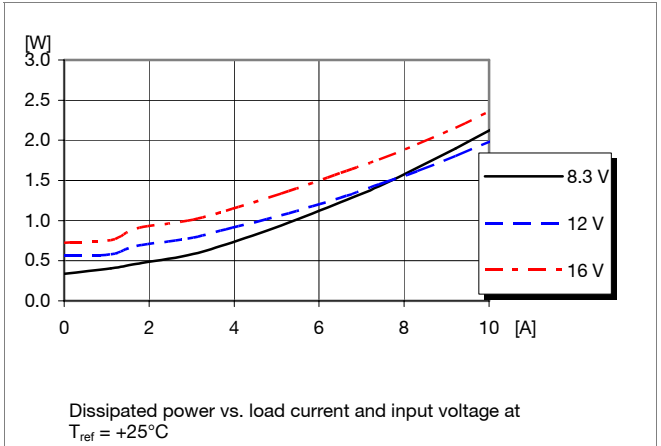

Output Current Derating

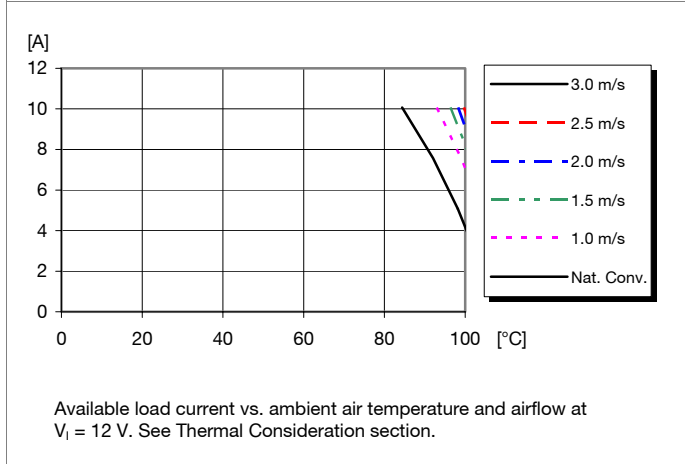

Thermal Resistance

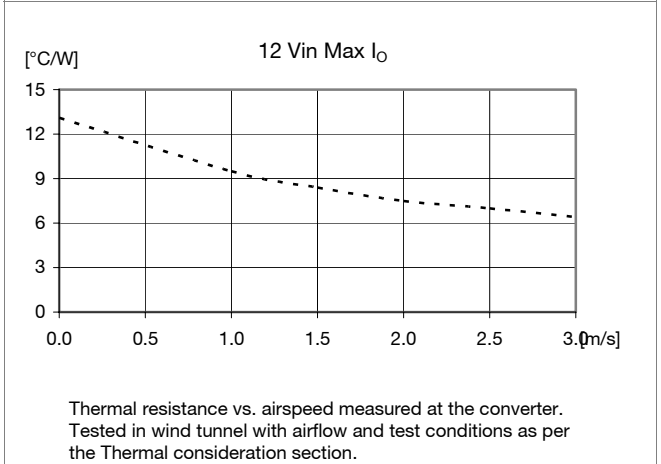

Output Characteristics

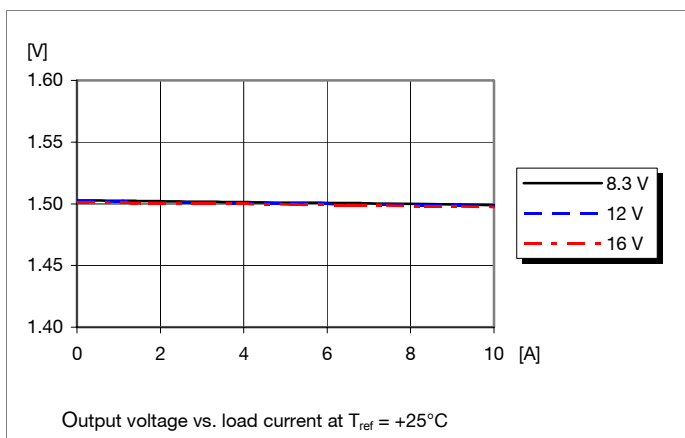

Current Limit Characteristics

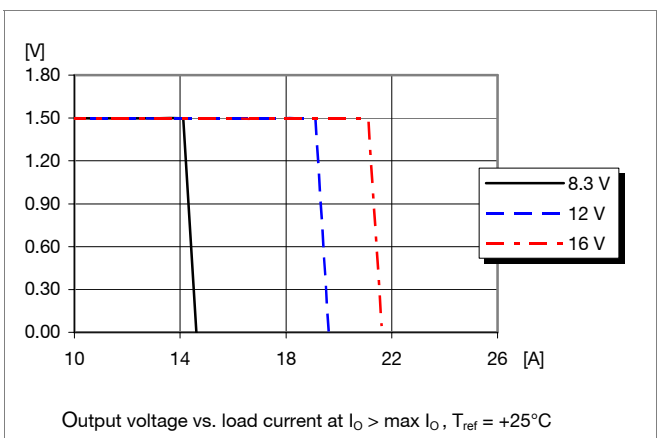

PMC 8518 series PoL Regulators
 Input 8.3 -16 V, Output up to 10 A / 50 W

2/28701-BMR 619 Rev.A November 2017
 © Flex

1.5 V/10 A Typical Characteristics

PMC 8518T S

Start-up

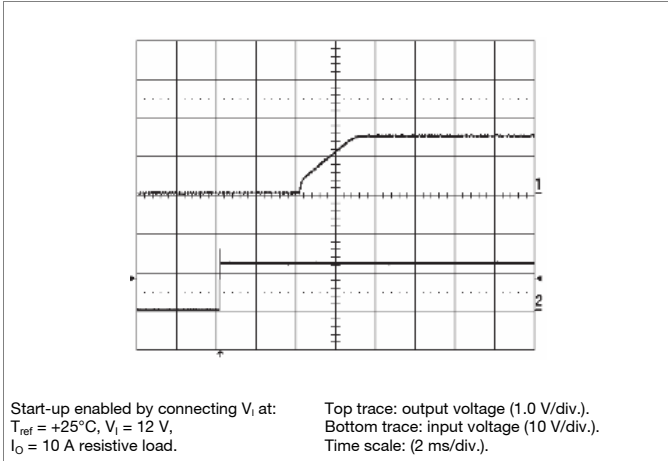

Shut-down

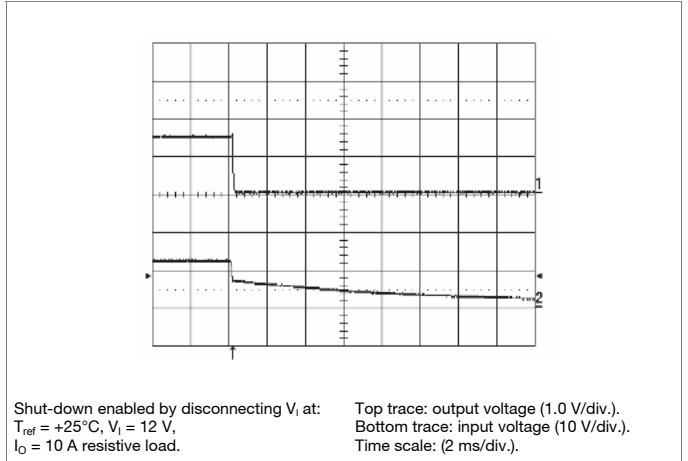

Output Ripple & Noise

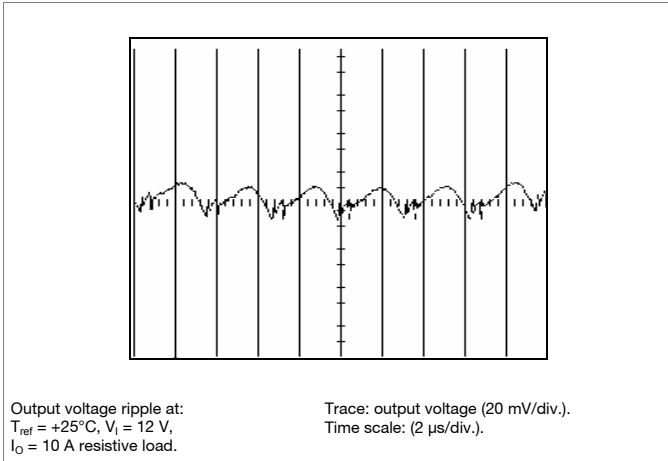

Output Load Transient Response

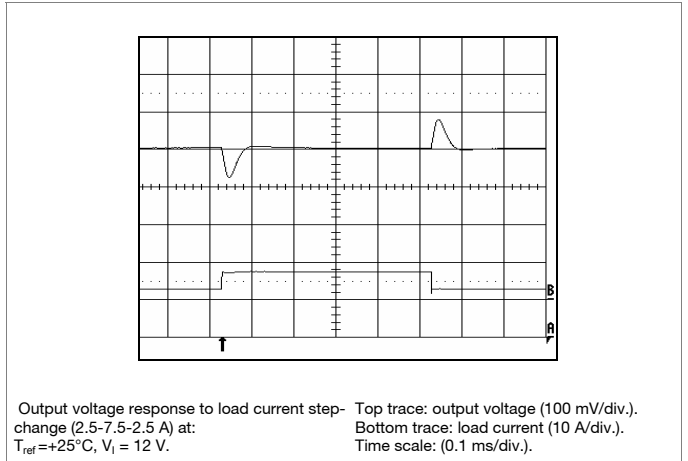

Output Voltage Adjust (see operating information)

PMC 8518 series PoL Regulators Input 8.3 -16 V, Output up to 10 A / 50 W	2/28701-BMR 619 Rev.A November 2017
	© Flex

1.8 V/10 A Electrical Specification

PMC 8518T S

$T_{ref} = -40$ to $+85^{\circ}\text{C}$, $V_I = 8.3$ to 16 V, $R_{adj} = 9.024$ k Ω , unless otherwise specified under Conditions.
 Typical values given at: $T_{ref} = +25^{\circ}\text{C}$, $V_I = 12$ V, max I_O , unless otherwise specified under Conditions.
 Additional $C_{in} = 4 \times 4.7$ μF and $C_{out} = 2 \times 150$ μF . See Operating Information section for selection of capacitor types.
 Connect the sense pin, where available, to the output pin.

Characteristics		Conditions	min	typ	max	Unit
V_I	Input voltage range		8.3		16	V
V_{loff}	Turn-off input voltage	Decreasing input voltage		7.8		V
V_{lon}	Turn-on input voltage	Increasing input voltage		8.0		V
C_I	Internal input capacitance			30		μF
P_O	Output power		0		18	W
η	Efficiency	50 % of max I_O		89.2		%
		max I_O		89.7		
P_d	Power Dissipation	max I_O		2.1	2.4	W
P_{li}	Input idling power	$I_O = 0$ A, $V_I = 12.0$ V		0.6		W
P_{RC}	Input standby power	$V_I = 12.0$ V (turned off with RC)		35		mW
I_s	Static Input current	$V_I = 12.0$ V, max I_O		1.7		A
f_s	Switching frequency	0-100 % of max I_O	260	300	340	kHz

V_{Oi}	Output voltage initial setting and accuracy	$T_{ref} = +25^{\circ}\text{C}$, $V_I = 12.0$ V, max I_O	-2		+2	%V
V_O	Output voltage tolerance band	10-100 % of max I_O	-3		+3	%V
	Idling voltage	$I_O = 0$ A	-2		+2	%V
	Line regulation	max I_O		2		mV
	Load regulation	$V_I = 12.0$ V, 0-100 % of max I_O		10		mV
V_{tr}	Load transient voltage deviation	$V_I = 12.0$ V, Load step 25-75-25 % of max I_O , $di/dt = 5$ A/ μs		± 100		mV
t_{tr}	Load transient recovery time			40		μs
t_r	Ramp-up time (from 10–90 % of V_O)	max I_O		3		ms
t_s	Start-up time (from V_I connection to 90 % of V_O)			7		ms
t_f	V_I shut-down fall time. (From V_I off to 10 % of V_O)	Max I_O		1		ms
		$I_O = 0$ A		18		s
t_{RC} t_{inh}	RC start-up time	Max I_O		7		ms
	RC shut-down fall time (From RC off to 10 % of V_O)	Max I_O		1		ms
		$I_O = 0$ A		18		s
I_O	Output current		0		10	A
I_{lim}	Current limit threshold	$T_{ref} < \text{max } T_{ref}$	13	19		A
I_{sc}	Short circuit current	$T_{ref} = 25^{\circ}\text{C}$, See Operating Information section.		19	21	A
V_{Oac}	Output ripple & noise	See ripple & noise section, max I_O		35	70	mVp-p

PMC 8518 series PoL Regulators
 Input 8.3 -16 V, Output up to 10 A / 50 W

2/28701-BMR 619 Rev.A November 2017
 © Flex

1.8 V/10 A Typical Characteristics

PMC 8518T S

Efficiency

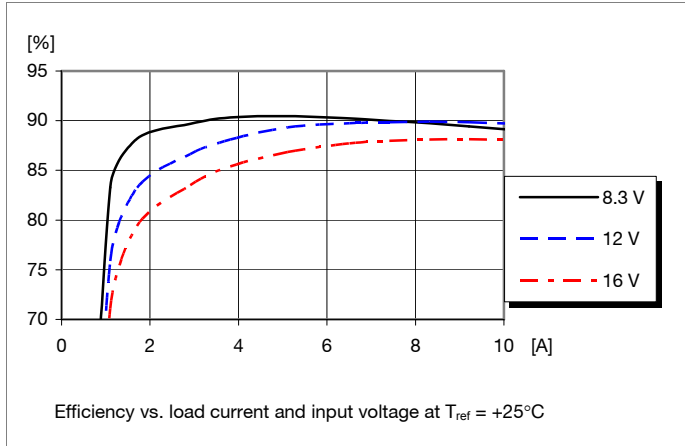

Power Dissipation

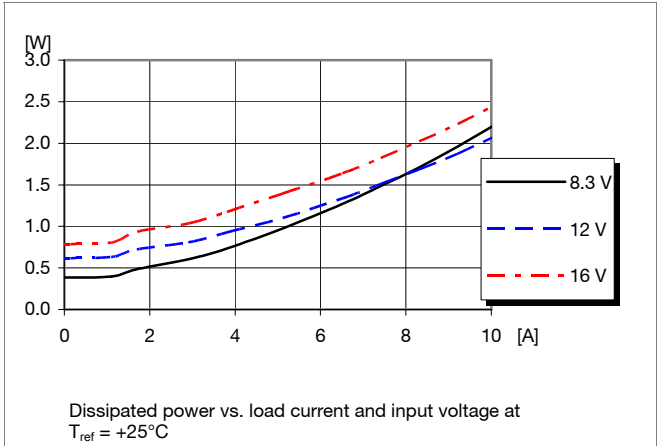

Output Current Derating

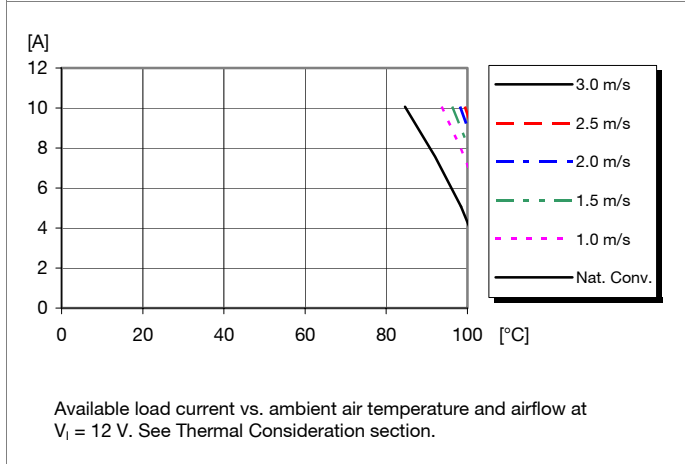

Thermal Resistance

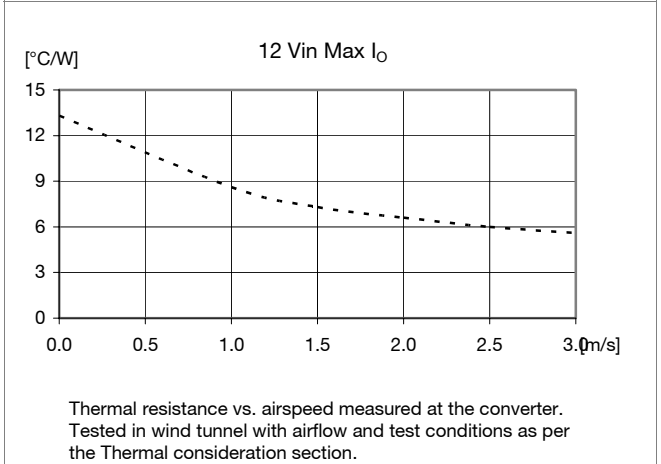

Output Characteristics

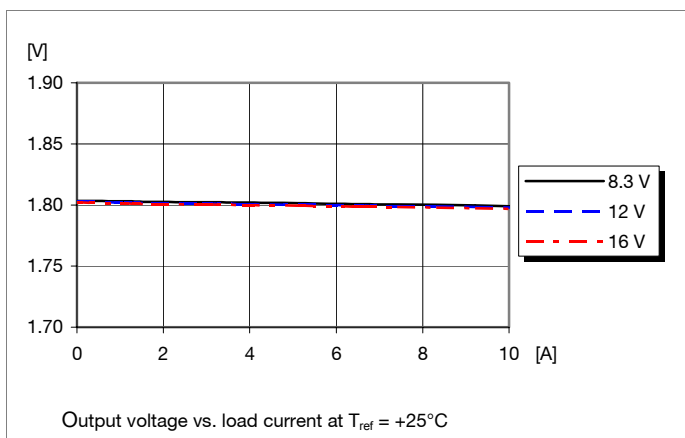

Current Limit Characteristics

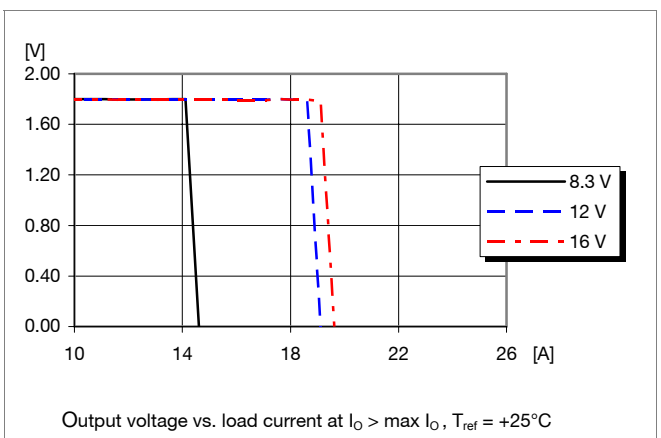

PMC 8518 series PoL Regulators
 Input 8.3 -16 V, Output up to 10 A / 50 W

2/28701-BMR 619 Rev.A November 2017
 © Flex

1.8 V/10 A Typical Characteristics

PMC 8518T S

Start-up

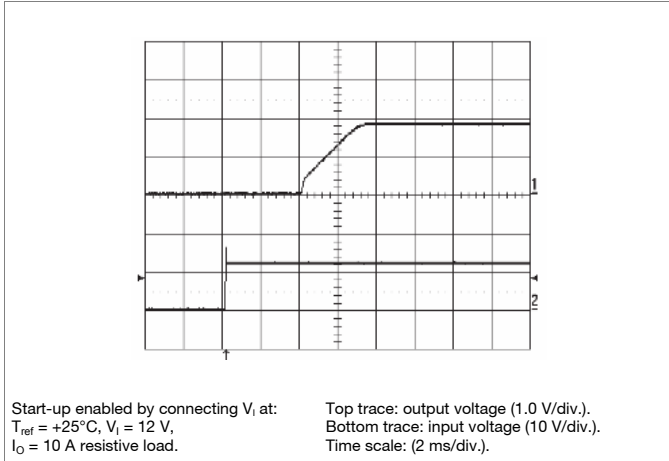

Shut-down

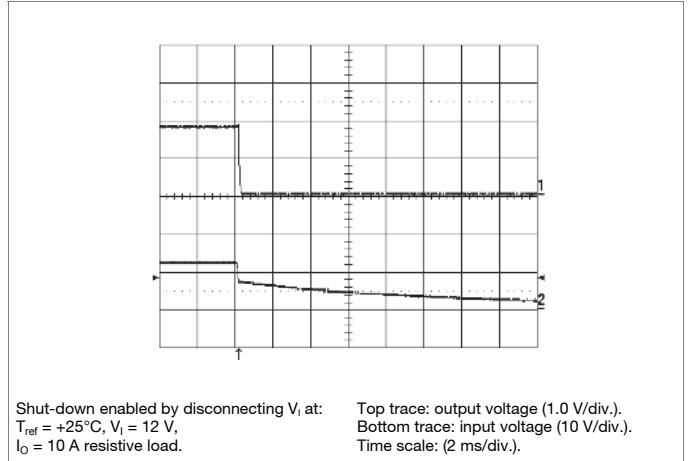

Output Ripple & Noise

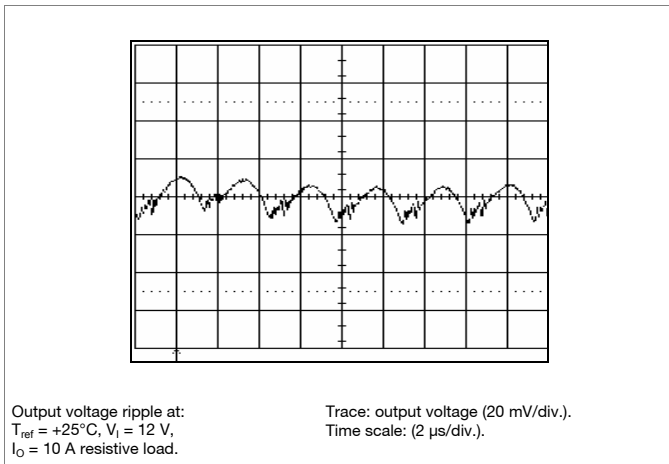

Output Load Transient Response

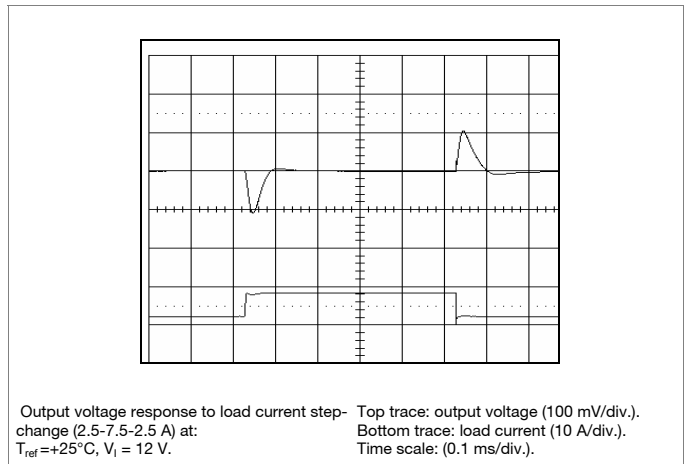

Output Voltage Adjust (see operating information)

PMC 8518 series PoL Regulators
 Input 8.3 -16 V, Output up to 10 A / 50 W

2/28701-BMR 619 Rev.A November 2017

© Flex

2.5 V/10 A Electrical Specification
PMC 8518T S
 $T_{ref} = -40$ to $+85^{\circ}\text{C}$, $V_I = 8.3$ to 16 V, $R_{adj} = 5.009$ k Ω , unless otherwise specified under Conditions.

 Typical values given at: $T_{ref} = +25^{\circ}\text{C}$, $V_I = 12$ V, max I_O , unless otherwise specified under Conditions.

 Additional $C_{in} = 4 \times 4.7$ μF and $C_{out} = 2 \times 150$ μF . See Operating Information section for selection of capacitor types.

Connect the sense pin, where available, to the output pin.

Characteristics		Conditions	min	typ	max	Unit
V_I	Input voltage range		8.3		16	V
V_{loff}	Turn-off input voltage	Decreasing input voltage		7.8		V
V_{lon}	Turn-on input voltage	Increasing input voltage		8.0		V
C_I	Internal input capacitance			30		μF
P_O	Output power		0		25	W
η	Efficiency	50 % of max I_O		91.2		%
		max I_O		91.8		
P_d	Power Dissipation	max I_O		2.2	2.5	W
P_{li}	Input idling power	$I_O = 0$ A, $V_I = 12.0$ V		0.7		W
P_{RC}	Input standby power	$V_I = 12.0$ V (turned off with RC)		35		mW
I_S	Static Input current	$V_I = 12.0$ V, max I_O		2.3		A
f_s	Switching frequency	0-100 % of max I_O	260	300	340	kHz

V_{Oi}	Output voltage initial setting and accuracy	$T_{ref} = +25^{\circ}\text{C}$, $V_I = 12.0$ V, max I_O	-2		+2	%V
V_O	Output voltage tolerance band	10-100 % of max I_O	-3		+3	%V
	Idling voltage	$I_O = 0$ A	-2		+2	%V
	Line regulation	max I_O		2		mV
	Load regulation	$V_I = 12.0$ V, 0-100 % of max I_O		10		mV
V_{tr}	Load transient voltage deviation	$V_I = 12.0$ V, Load step 25-75-25 % of max I_O , $di/dt = 5$ A/ μs		± 100		mV
t_{tr}	Load transient recovery time			40		μs
t_r	Ramp-up time (from 10–90 % of V_O)	max I_O		3		ms
t_s	Start-up time (from V_I connection to 90 % of V_O)			7		ms
t_f	V_I shut-down fall time. (From V_I off to 10 % of V_O)	Max I_O		1		ms
		$I_O = 0$ A		16		s
t_{RC} t_{inh}	RC start-up time	Max I_O		7		ms
	RC shut-down fall time (From RC off to 10 % of V_O)	Max I_O		1		ms
		$I_O = 0$ A		16		s
I_O	Output current		0		10	A
I_{lim}	Current limit threshold	$T_{ref} < \max T_{ref}$	13	19		A
I_{sc}	Short circuit current	$T_{ref} = 25^{\circ}\text{C}$, See Operating Information section.		19	21	A
V_{Oac}	Output ripple & noise	See ripple & noise section, max I_O		35	70	mVp-p

PMC 8518 series PoL Regulators
 Input 8.3 -16 V, Output up to 10 A / 50 W

2/28701-BMR 619 Rev.A November 2017
 © Flex

2.5 V/10 A Typical Characteristics

PMC 8518T S

Efficiency

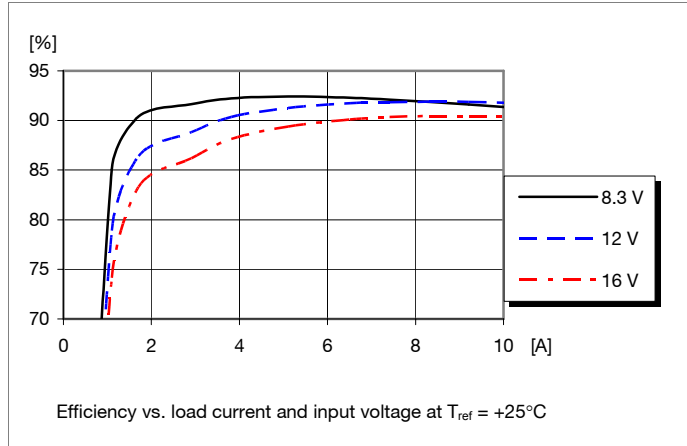

Power Dissipation

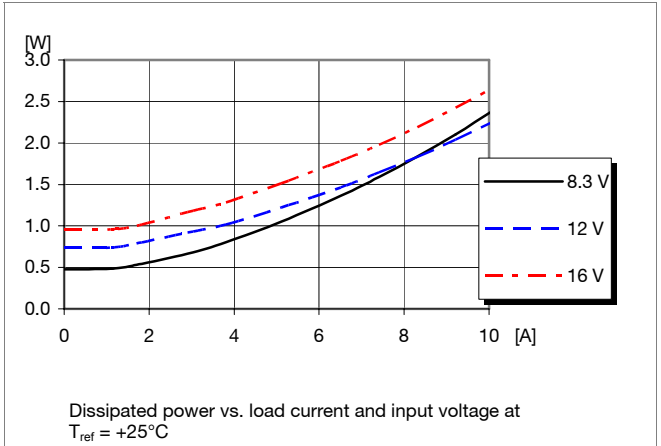

Output Current Derating

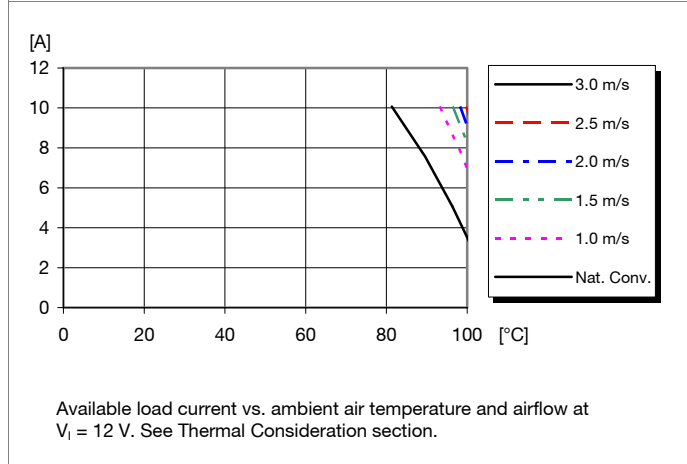

Thermal Resistance

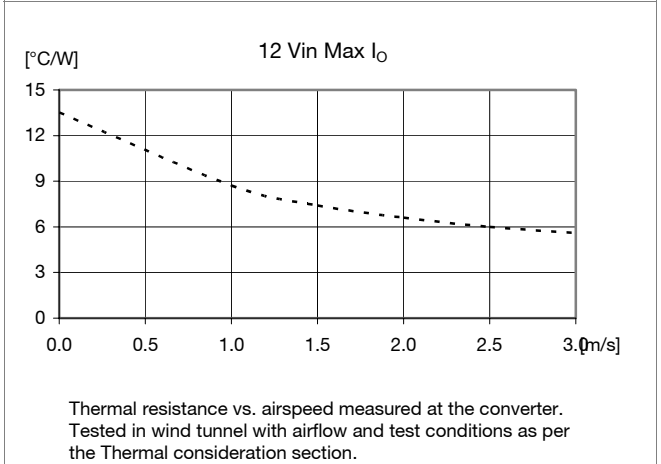

Output Characteristics

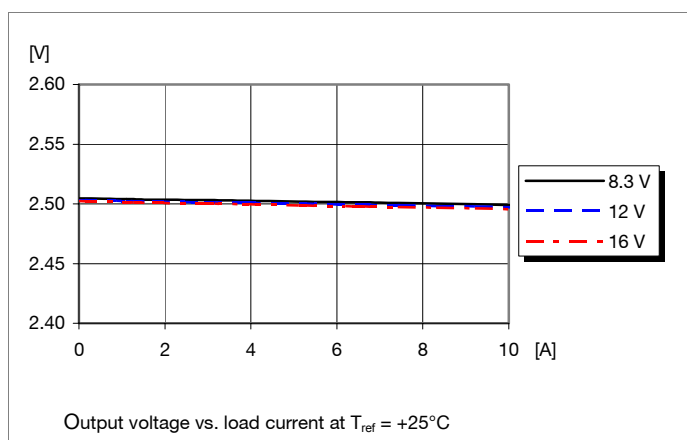

Current Limit Characteristics

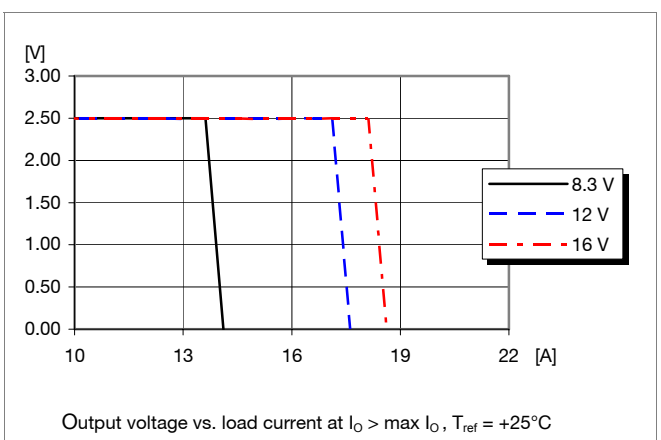

PMC 8518 series PoL Regulators
 Input 8.3 -16 V, Output up to 10 A / 50 W

2/28701-BMR 619 Rev.A November 2017
 © Flex

2.5 V/10 A Typical Characteristics

PMC 8518T S

Start-up

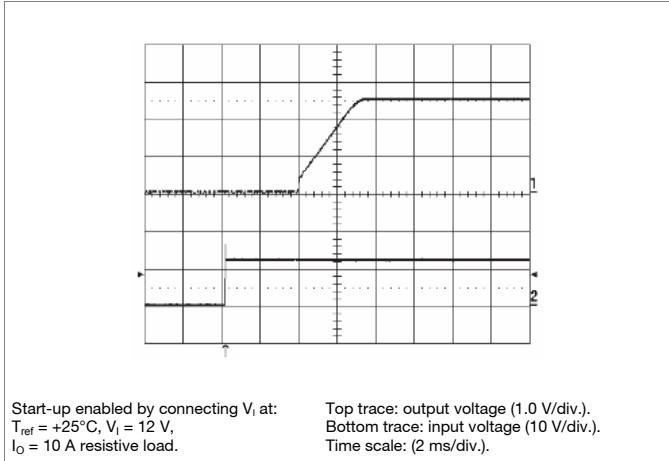

Shut-down

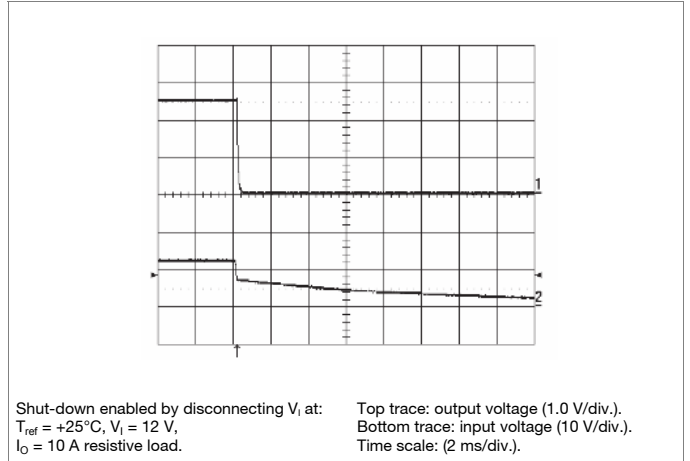

Output Ripple & Noise

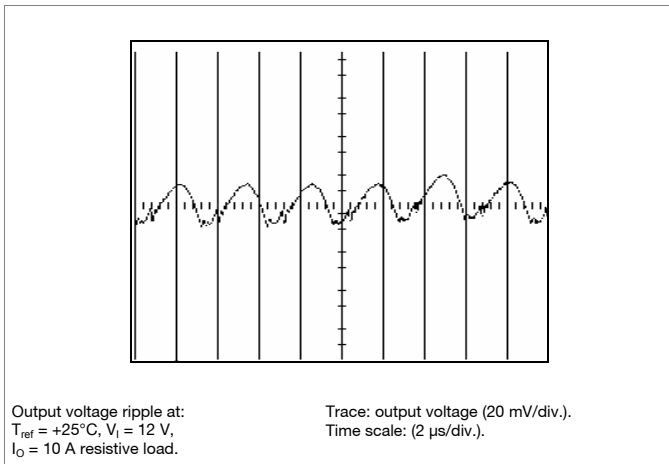

Output Load Transient Response

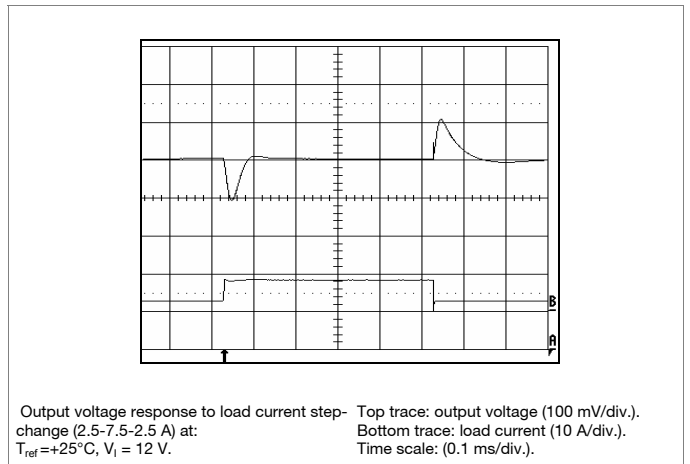

Output Voltage Adjust (see operating information)

PMC 8518 series PoL Regulators
Input 8.3 -16 V, Output up to 10 A / 50 W

2/28701-BMR 619 Rev.A November 2017
© Flex

3.3 V/10 A Electrical Specification

PMC 8518T S

$T_{ref} = -40$ to $+85^{\circ}\text{C}$, $V_I = 8.3$ to 16 V, $R_{adj} = 3.122$ k Ω , unless otherwise specified under Conditions.
Typical values given at: $T_{ref} = +25^{\circ}\text{C}$, $V_I = 12$ V, max I_O , unless otherwise specified under Conditions.
Additional $C_{in} = 4 \times 4.7$ μF and $C_{out} = 2 \times 150$ μF . See Operating Information section for selection of capacitor types.
Connect the sense pin, where available, to the output pin.

Characteristics		Conditions	min	typ	max	Unit
V_I	Input voltage range		8.3		16	V
V_{loff}	Turn-off input voltage	Decreasing input voltage		7.8		V
V_{lon}	Turn-on input voltage	Increasing input voltage		8.0		V
C_I	Internal input capacitance			30		μF
P_O	Output power		0		33	W
η	Efficiency	50 % of max I_O		92.6		%
		max I_O		93.2		
P_d	Power Dissipation	max I_O		2.4	2.7	W
P_{li}	Input idling power	$I_O = 0$ A, $V_I = 12.0$ V		0.9		W
P_{RC}	Input standby power	$V_I = 12.0$ V (turned off with RC)		35		mW
I_S	Static Input current	$V_I = 12.0$ V, max I_O		3.0		A
f_s	Switching frequency	0-100 % of max I_O	260	300	340	kHz

V_{Oi}	Output voltage initial setting and accuracy	$T_{ref} = +25^{\circ}\text{C}$, $V_I = 12.0$ V, max I_O	-2		+2	%V
V_O	Output voltage tolerance band	10-100 % of max I_O	-3		+3	%V
	Idling voltage	$I_O = 0$ A	-2		+2	%V
	Line regulation	max I_O		2		mV
	Load regulation	$V_I = 12.0$ V, 0-100 % of max I_O		10		mV
V_{tr}	Load transient voltage deviation	$V_I = 12.0$ V, Load step 25-75-25 % of max I_O , $di/dt = 5$ A/ μs		± 100		mV
t_{tr}	Load transient recovery time			40		μs
t_r	Ramp-up time (from 10-90 % of V_O)	max I_O		3		ms
t_s	Start-up time (from V_I connection to 90 % of V_O)			7		ms
t_f	V_I shut-down fall time. (From V_I off to 10 % of V_O)	Max I_O		1		ms
		$I_O = 0$ A		16		s
t_{RC} t_{inh}	RC start-up time	Max I_O		7		ms
	RC shut-down fall time (From RC off to 10 % of V_O)	Max I_O		1		ms
		$I_O = 0$ A		16		s
I_O	Output current		0		10	A
I_{lim}	Current limit threshold	$T_{ref} < \text{max } T_{ref}$	12	17		A
I_{sc}	Short circuit current	$T_{ref} = 25^{\circ}\text{C}$, See Operating Information section.		17	19	A
V_{Oac}	Output ripple & noise	See ripple & noise section, max I_O		35	70	mVp-p

PMC 8518 series PoL Regulators
 Input 8.3 -16 V, Output up to 10 A / 50 W

2/28701-BMR 619 Rev.A November 2017
 © Flex

3.3 V/10 A Typical Characteristics

PMC 8518T S

Efficiency

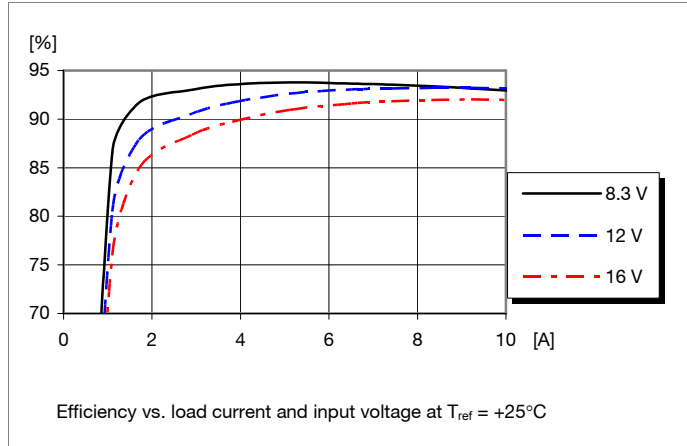

Power Dissipation

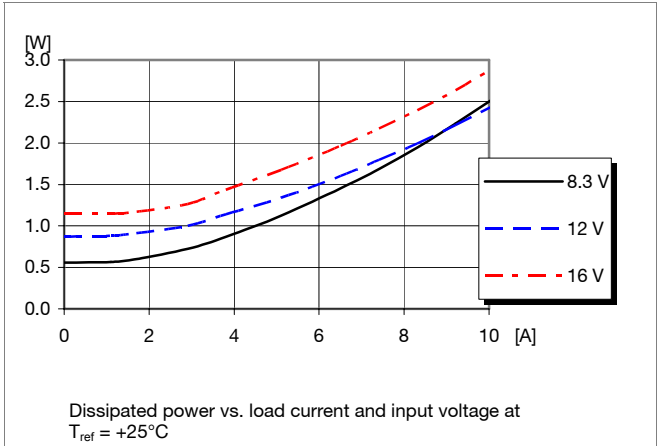

Output Current Derating

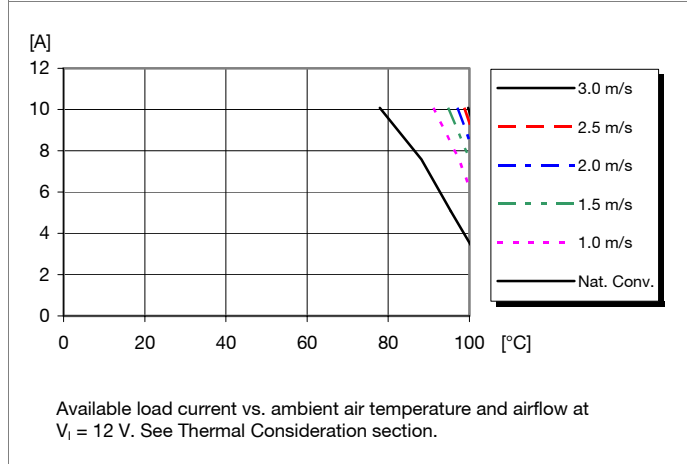

Thermal Resistance

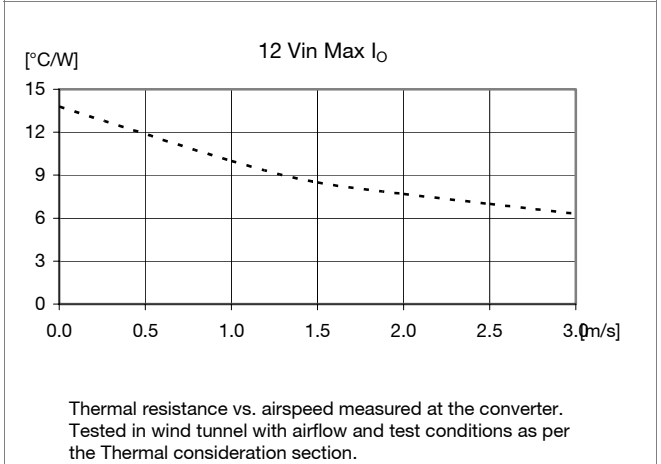

Output Characteristics

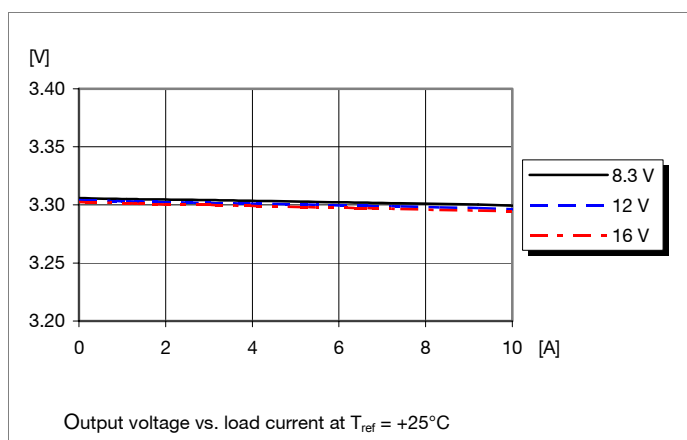

Current Limit Characteristics

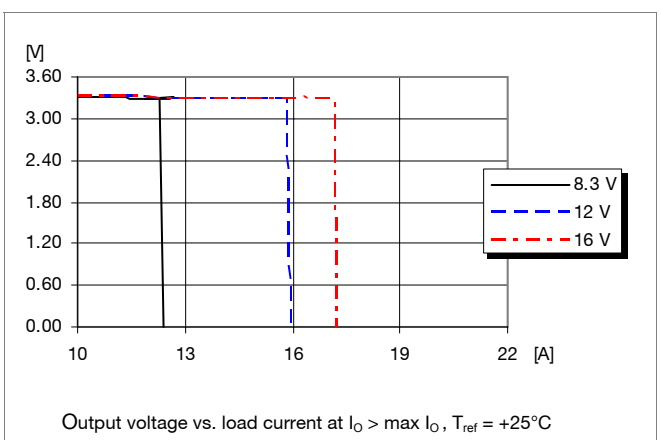

PMC 8518 series PoL Regulators
 Input 8.3 -16 V, Output up to 10 A / 50 W

2/28701-BMR 619 Rev.A November 2017
 © Flex

3.3 V/10 A Typical Characteristics

PMC 8518T S

Start-up

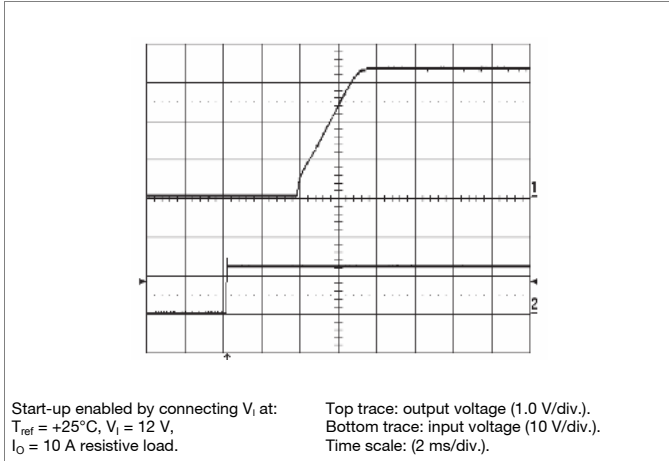

Shut-down

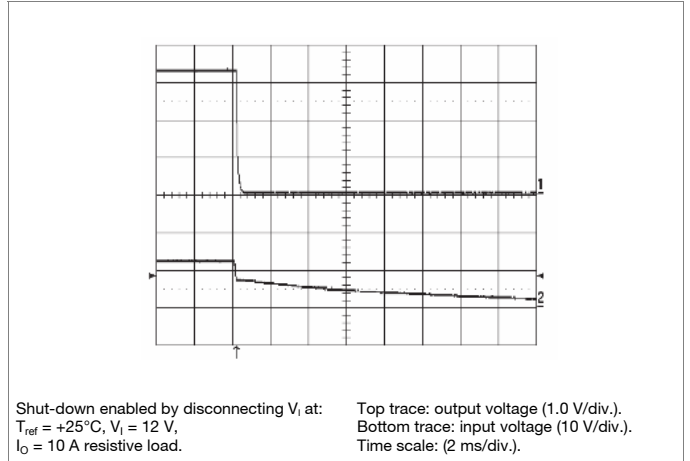

Output Ripple & Noise

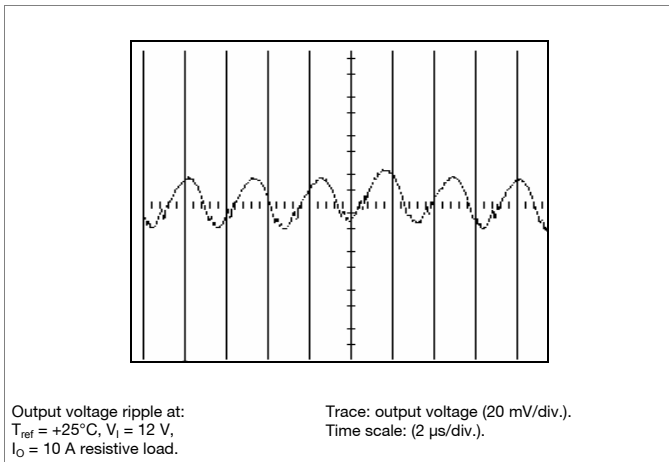

Output Load Transient Response

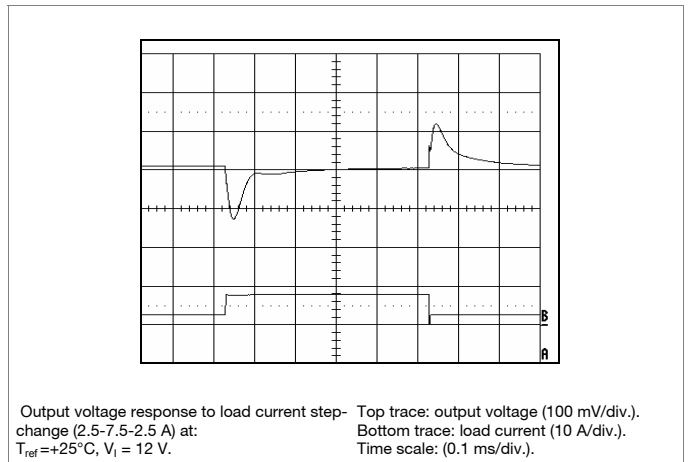

Output Voltage Adjust (see operating information)

PMC 8518 series PoL Regulators
 Input 8.3 -16 V, Output up to 10 A / 50 W

2/28701-BMR 619 Rev.A November 2017

© Flex

5.0 V/10 A Electrical Specification
PMC 8518T S
 $T_{ref} = -40$ to $+85^{\circ}\text{C}$, $V_I = 8.3$ to 16 V, $R_{adj} = 1.472$ k Ω , unless otherwise specified under Conditions.

 Typical values given at: $T_{ref} = +25^{\circ}\text{C}$, $V_I = 12$ V, max I_O , unless otherwise specified under Conditions.

 Additional $C_{in} = 4 \times 4.7$ μF and $C_{out} = 2 \times 150$ μF . See Operating Information section for selection of capacitor types.

Connect the sense pin, where available, to the output pin.

Characteristics		Conditions	min	typ	max	Unit
V_I	Input voltage range		8.3		16	V
V_{loff}	Turn-off input voltage	Decreasing input voltage		7.8		V
V_{lon}	Turn-on input voltage	Increasing input voltage		8.0		V
C_I	Internal input capacitance			30		μF
P_O	Output power		0		50	W
η	Efficiency	50 % of max I_O		94.3		%
		max I_O		94.8		
P_d	Power Dissipation	max I_O		2.7	3.0	W
P_{li}	Input idling power	$I_O = 0$ A, $V_I = 12.0$ V		1.1		W
P_{RC}	Input standby power	$V_I = 12.0$ V (turned off with RC)		35		mW
I_S	Static Input current	$V_I = 12.0$ V, max I_O		4.4		A
f_s	Switching frequency	0-100 % of max I_O	260	300	340	kHz

V_{Oi}	Output voltage initial setting and accuracy	$T_{ref} = +25^{\circ}\text{C}$, $V_I = 12.0$ V, max I_O	-2		+2	%V
V_O	Output voltage tolerance band	10-100 % of max I_O	-3		+3	%V
	Idling voltage	$I_O = 0$ A	-2		+2	%V
	Line regulation	max I_O		2		mV
	Load regulation	$V_I = 12.0$ V, 0-100 % of max I_O		10		mV
V_{tr}	Load transient voltage deviation	$V_I = 12.0$ V, Load step 25-75-25 % of max I_O , $di/dt = 5$ A/ μs		± 100		mV
t_{tr}	Load transient recovery time			40		μs
t_r	Ramp-up time (from 10–90 % of V_O)	max I_O		3		ms
t_s	Start-up time (from V_I connection to 90 % of V_O)			7		ms
t_f	V_I shut-down fall time. (From V_I off to 10 % of V_O)	Max I_O		1		ms
		$I_O = 0$ A		16		s
t_{RC} t_{inh}	RC start-up time	Max I_O		7		ms
	RC shut-down fall time (From RC off to 10 % of V_O)	Max I_O		1		ms
		$I_O = 0$ A		15		s
I_O	Output current		0		10	A
I_{lim}	Current limit threshold	$T_{ref} < \max T_{ref}$	11	14		A
I_{sc}	Short circuit current	$T_{ref} = 25^{\circ}\text{C}$, See Operating Information section.		14	16	A
V_{Oac}	Output ripple & noise	See ripple & noise section, max I_O		35	70	mVp-p

PMC 8518 series PoL Regulators
 Input 8.3 -16 V, Output up to 10 A / 50 W

2/28701-BMR 619 Rev.A November 2017
 © Flex

5.0 V/10 A Typical Characteristics

PMC 8518T S

Efficiency

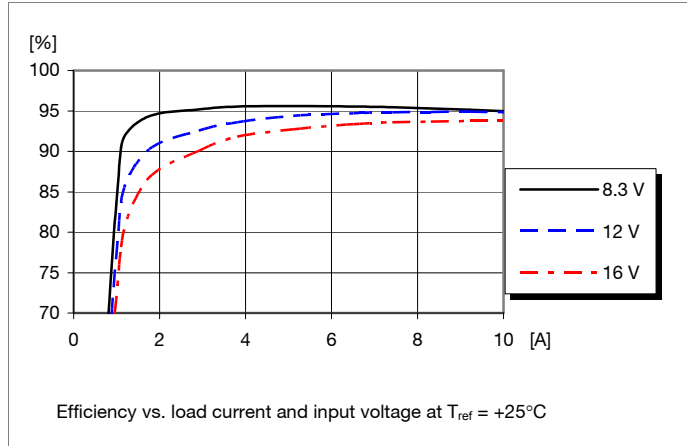

Power Dissipation

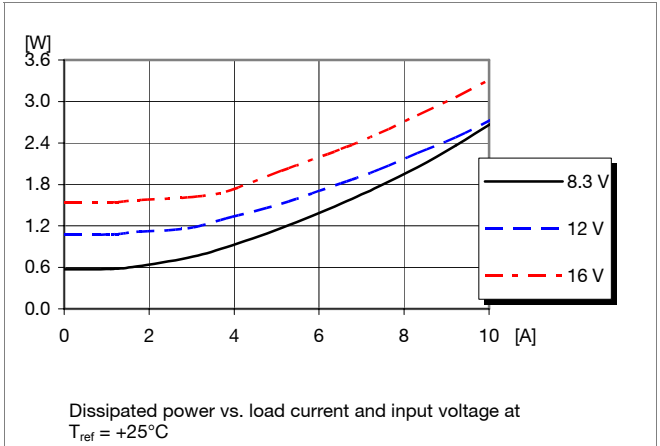

Output Current Derating

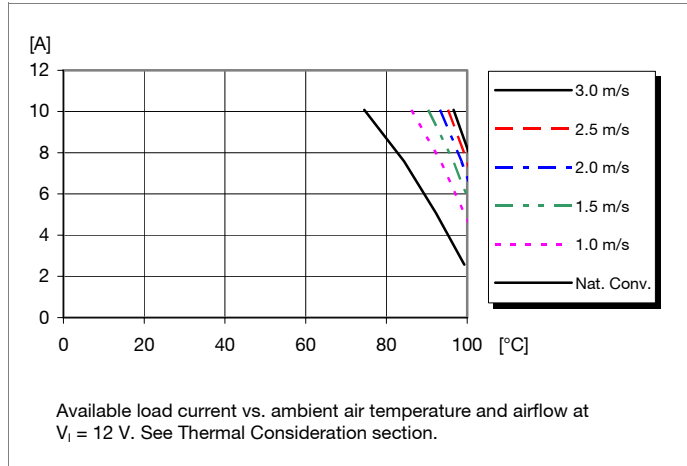

Thermal Resistance

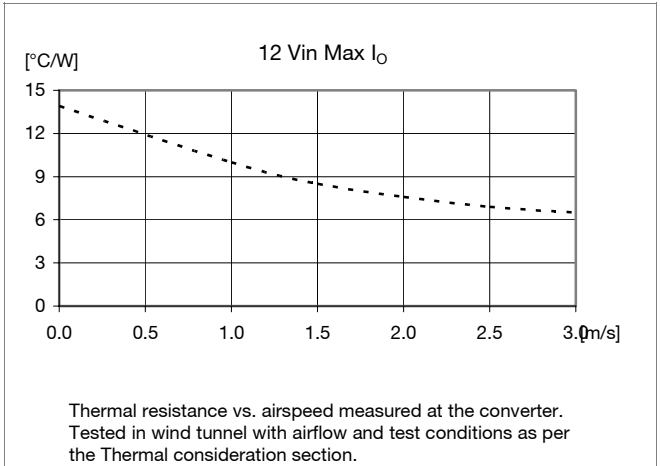

Output Characteristics

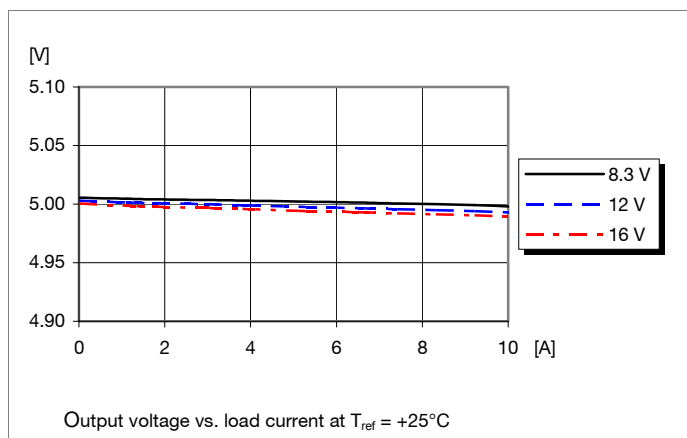

Current Limit Characteristics

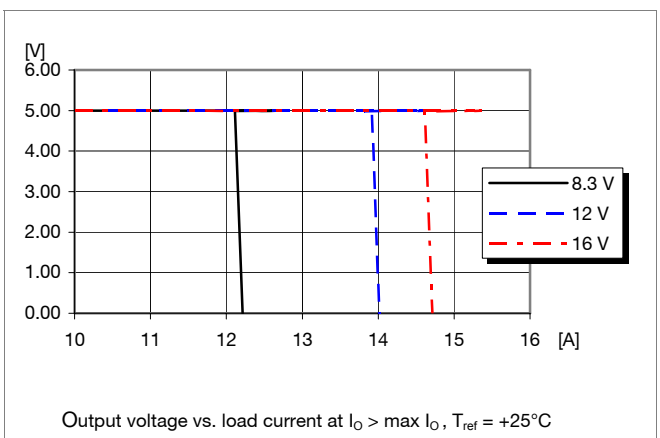

PMC 8518 series PoL Regulators
 Input 8.3 -16 V, Output up to 10 A / 50 W

2/28701-BMR 619 Rev.A November 2017
 © Flex

5.0 V/10 A Typical Characteristics

PMC 8518T S

Start-up

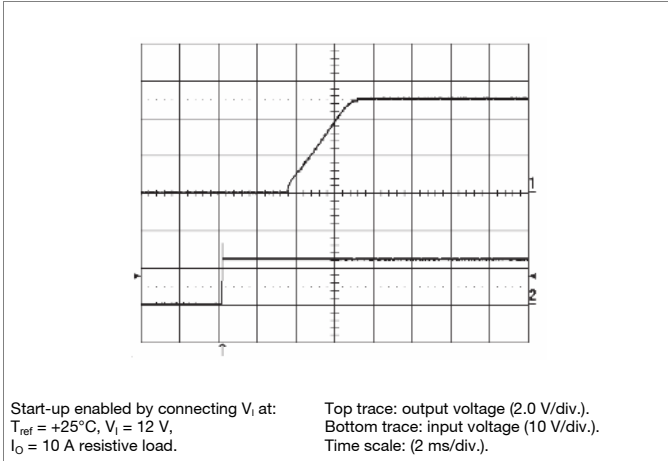

Shut-down

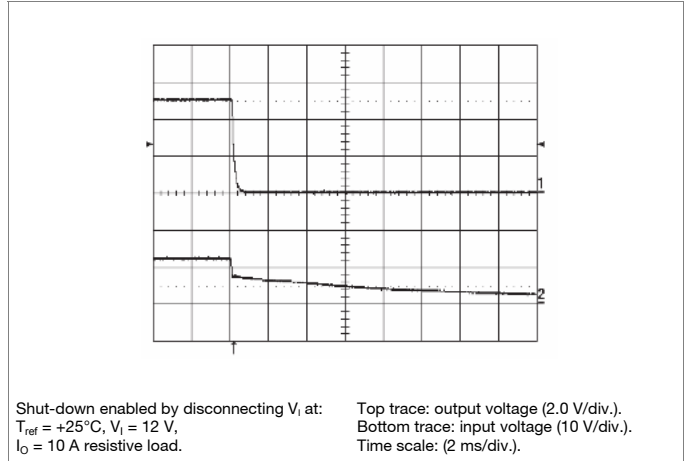

Output Ripple & Noise

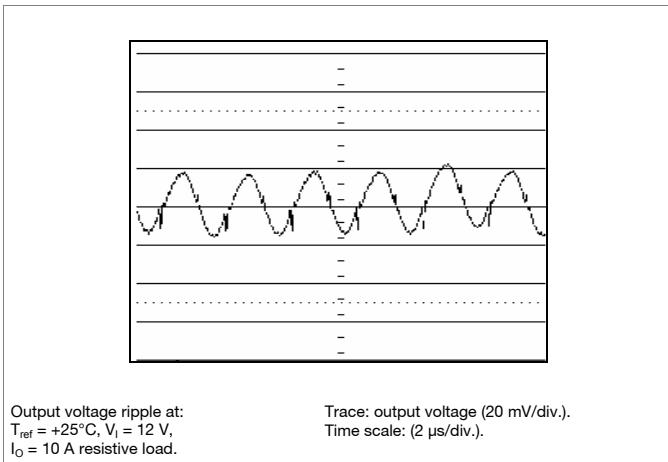

Output Load Transient Response

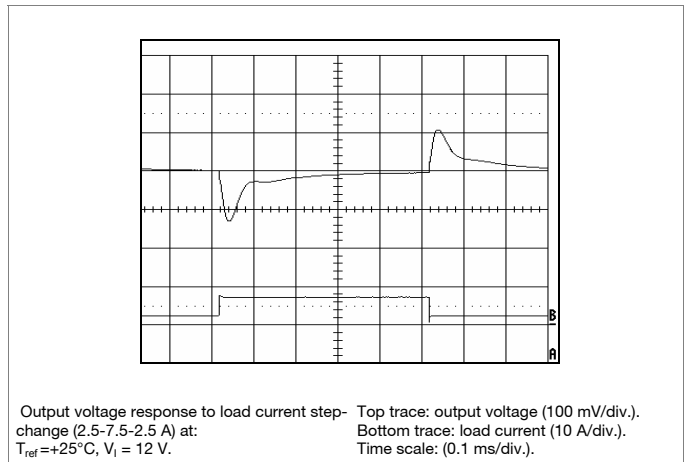

Output Voltage Adjust (see operating information)

PMC 8518 series PoL Regulators
 Input 8.3 -16 V, Output up to 10 A / 50 W

2/28701-BMR 619 Rev.A November 2017
 © Flex

EMC Specification

Conducted EMI measured according to test set-up. The fundamental switching frequency is 300 kHz for PMC 8518T S @ $V_I = 12\text{ V}$, max I_O .

Conducted EMI Input terminal value (typ)

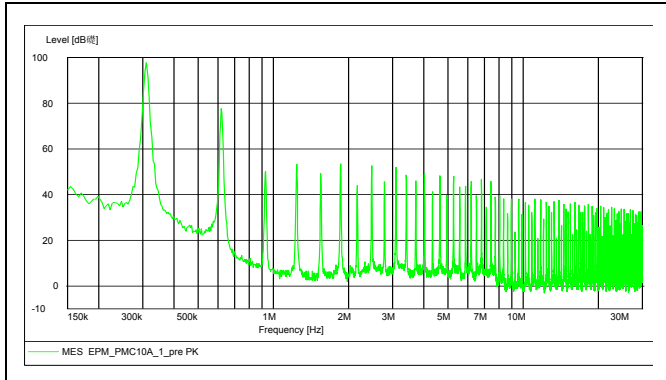

EMI without filter

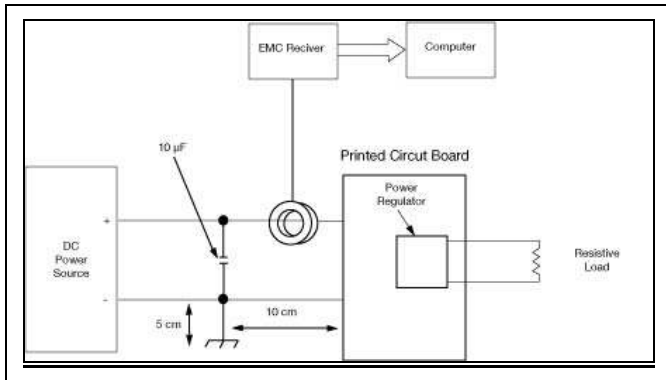

Test set-up

Layout recommendation

The radiated EMI performance of the DC/DC regulator will depend on the PCB layout and ground layer design. It is also important to consider the stand-off of the DC/DC regulator.

If a ground layer is used, it should be connected to the output of the DC/DC regulator and the equipment ground or chassis.

A ground layer will increase the stray capacitance in the PCB and improve the high frequency EMC performance.

Output ripple and noise

Output ripple and noise measured according to figure below. See Design Note 022 for detailed information.

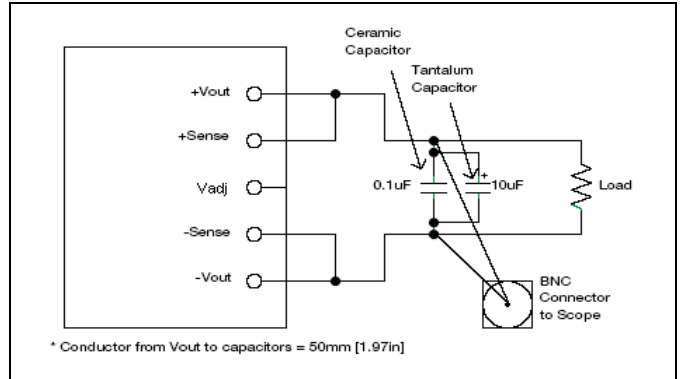

Output ripple and noise test setup

Operating information

See "Output Voltage Adjust (Vadj)" section.

Input Voltage

The input voltage range 8.3 to 16 Vdc makes the PMC 8000 easy to use in intermediate bus applications when powered by a regulated bus converter. For output voltage trims over 5.25 Vout, the input voltage must be reduced to a maximum of 14 V in order to maintain specified data.

Turn-off Input Voltage

The PMC 8000 Series DC/DC regulators monitor the input voltage and will turn on and turn off at predetermined levels. The minimum hysteresis between turn on and turn off input voltage is 0.2V where the turn on input voltage is the highest.

Remote Control (RC)

Standard Version with "positive logic"

The RC pin may be used to turn on or turn off the regulator using a suitable open collector function.

Turn off is achieved by connecting the RC pin to ground. The regulator will run in normal operation when the RC pin is left open.

RC	Regulator condition	Min	Typ	Max	Unit
Low level	OFF	-0.3		0.3	V
Open	ON	1.7		16	V

PMC 8518 series PoL Regulators
 Input 8.3 -16 V, Output up to 10 A / 50 W

2/28701-BMR 619 Rev.A November 2017
 © Flex

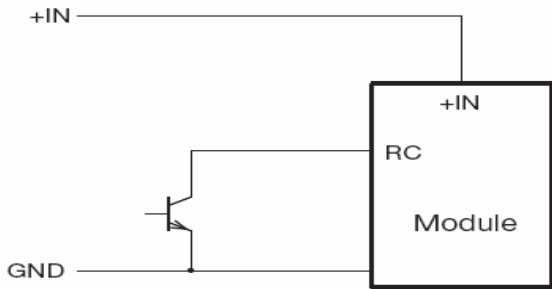

Standard Version with “negative logic”

The RC pin may be used to turn on or turn off the regulator using a suitable open collector function. Turn off is achieved by connecting the RC pin to the input voltage. The regulator will run in normal operation when the RC pin is left open.

RC	Regulator condition	Min	Typ	Max	Unit
High level	OFF	1.7		16	V
Open	ON				V

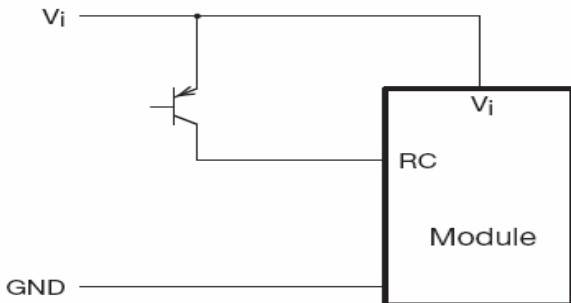

External Capacitors

Required Input Filter:
 External input capacitors are required to increase the lifetime of the internal capacitors. Low ESR ceramics should be used, the minimum input capacitance is stated below.

PMC 8518T S 1 x 4.7 uF.

Optional Input Filter:
 To minimize input ripple and to ensure even better stability more capacitors can be added, see table below. Consider the max output power in a given application and choose sufficient capacitors to obtain desired ripple level. Make sure that the extra capacitors are placed near the input pins. The table below is just an example since the board layout also has effect on the result.

Output power	Desired input ripple (mVp-p)		
	150	250	500
0-20 W	2x4.7uF	-----	-----

20-40 W	5x4.7uF	2x4.7uF	-----
40-50 W	8x4.7uF	4x4.7uF	2x4.7uF

Required output filter:

External output capacitance is also required to reduce the output ripple and to obtain specified load step response. It is recommended to use low ESR polymer capacitors or low ESR ceramic capacitors.

Minimum requirement:

PMC 8518T S 2 x 150 uF. (low ESR polymer type).
 This is the output filter used in the verification and a requirement to meet the specification.

Input And Output Impedance

The impedance of both the power source and the load will interact with the impedance of the DC/DC regulator. It is most important to have low characteristic impedance, both at the input and output, as the regulators have a low energy storage capability. Use capacitors across the input if the source inductance is greater than 4.7 uH. Suitable input capacitors are 22 uF - 220 uF low ESR ceramics.

Maximum Capacitive Load

When powering loads with significant dynamic current requirements, the voltage regulation at the load can be improved by addition of decoupling capacitance at the load. The most effective technique is to locate low ESR ceramic capacitors as close to the load as possible, using several capacitors to lower the total ESR. These ceramic capacitors will handle short duration high-frequency components of dynamic load changes. In addition, higher values of capacitors (electrolytic capacitors) should be used to handle the mid-frequency components. It is equally important to use good design practice when configuring the DC distribution system.

Low resistance and low inductance PCB layouts and cabling should be used. Remember that when using remote sensing, all resistance (including the ESR), inductance and capacitance of the distribution system is within the feedback loop of the regulator. This can affect on the regulators compensation and the resulting stability and dynamic response performance.

Very low ESR and high capacitance must be used with care. A “rule of thumb” is that the total capacitance must never exceed typically 500-700 uF if only low ESR (< 2 mΩ) ceramic capacitors are used. If more capacitance is needed, a combination of low ESR type and electrolytic capacitors should be used; otherwise the stability will be affected. The PMC 8000 series regulator can accept up to 5 mF of capacitive load on the output at full load. This gives <500 uF/A of Io. When using that large capacitance it is important to consider the selection of output capacitors; the resulting behaviour is a combination of the amount of capacitance and ESR.

A combination of low ESR and output capacitance exceeding

PMC 8518 series PoL Regulators
Input 8.3 -16 V, Output up to 10 A / 50 W

2/28701-BMR 619 Rev.A November 2017

© Flex

5 mF for PMC 8518 can cause the regulator into over current protection mode (hick-up) due to high start up current. The output filter must therefore be designed without exceeding the above stated capacitance levels if the ESR is lower then 30-40 mΩ.

Output Voltage Adjust (V_{adj})

All PMC 8000 Series DC/DC regulators have an Output Voltage adjust pin(V_{adj}). This pin can be used to adjust the output voltage about output voltage initial setting(0.75V). When increasing the output voltage the maximum power rating of the converter remains the same, and the output current capability will therefore decrease correspondingly. To increase the output voltage a resistor or a voltage signal should be connected/applied between V_{adj} pin and GND. The resistor/voltage signal value for some standard output setpoints are given below, for other voltage setpoints use the formulas to calculate the correct resistor or voltage signal. For output voltages of 5.25V and higher the input voltage is restricted to maximum $14V_{in}$.

Formula 1: $R_{adj} = (10500/(V_{out} - 0.7525)) - 1000$ (ohm)

Formula 2: $V_{trim} = (0.7 - 0.0667 \times (V_{out} - 0.7525))$ (V)

V_{out} (V)	R_{adj} (kohm)	V_{trim} (V)
0.75	Open	Open
1.00	41.42	0.684
1.20	22.46	0.670
1.50	13.05	0.650
1.80	9.024	0.630
2.50	5.009	0.583
3.30	3.122	0.530
5.00	1.472	0.417
5.50	1.212	0.383

Parallel Operation

The PMC 8000 Series DC/DC regulators can be connected in parallel with a common input. Paralleling is accomplished by connecting the output voltage pins directly and using a load sharing device on the input. Layout considerations should be made to avoid load imbalance. For more details on paralleling, please consult your local applications support.

Remote Sense

All PMC 8000 Series DC/DC regulators have a positive remote sense pin that can be used to compensate for moderate amounts of resistance in the distribution system and allow for voltage regulation at the load or other selected point. The remote sense line will carry very little current and does not need a large cross sectional area. However, the sense line on the PCB should be located close to a ground trace or ground plane. The remote sense circuitry will compensate for up to 10% voltage drop between the sense voltage and the voltage at the output pins from V_{onm} . If the remote sense is not needed the sense pin should be left open or connected to the positive output.

Over Temperature Protection (OTP)

The PMC 8000 Series DC/DC regulators are protected from thermal overload by an internal over temperature shutdown circuit. When the PCB temperature near the IC circuit reaches 130 °C the converter will shut down immediately. The regulator will make continuous attempts to start up (non-latching mode) and resume normal operation automatically when the temperature has dropped below the temperature threshold.

Over Current Protection (OCP)

The PMC 8000 Series DC/DC regulators include current limiting circuitry that allows them to withstand continuous overloads or short circuit conditions on the output. The output voltage will decrease towards zero for output currents in excess of max output current (I_{omax}). When the current limit is reached the regulator will go into hiccup mode. The current limit is temperature dependent, i.e. the limit decrease at higher operating temperature, the regulator is guaranteed to start at $I_{omax} \times 1.25$ @ Tref 115°C. The regulator will resume normal operation after removal of the overload. The load distribution system should be designed to carry the maximum output short circuit current specified.

PMC 8518 series PoL Regulators
Input 8.3 -16 V, Output up to 10 A / 50 W

2/28701-BMR 619 Rev.A November 2017

© Flex

Thermal Consideration

General

The regulators are designed to operate in different thermal environments and sufficient cooling must be provided to ensure reliable operation.

Cooling is achieved mainly by conduction, from the pins to the host board, and convection, which is dependant on the airflow across the regulator. Increased airflow enhances the cooling of the regulator.

The Output Current Derating graph found in the Output section for each model provides the available output current vs. ambient air temperature and air velocity at $V_{in} = 12 V$.

The DC/DC regulator is tested on a 254 x 254 mm, 35 μm (1 oz), 8-layer test board mounted vertically in a wind tunnel with a cross-section of 305 x 305 mm.

Proper cooling of the DC/DC regulator can be verified by measuring the temperature at positions P1, P2 and P3. The temperature at these positions should not exceed the max values provided in the table below.

Note that the max value is the absolute maximum rating (non destruction) and that the electrical Output data is guaranteed up to T_{ref} .

See Design Note 019 for further information.

Position	Device	Designation	max value
P ₁	Pcb		
P ₂	Mosfet	T_{ref}	115° C
P ₃	Inductor		

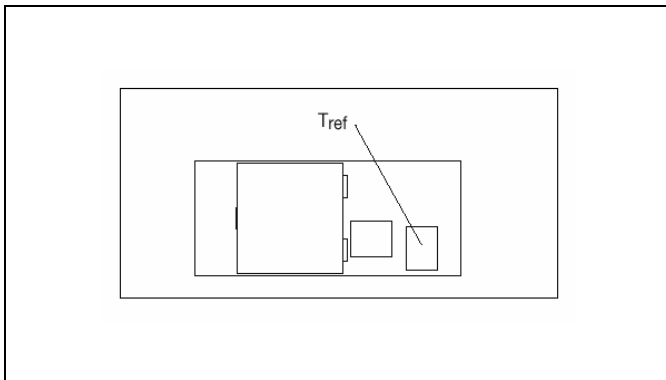

PMC 8518 series PoL Regulators
 Input 8.3 -16 V, Output up to 10 A / 50 W

2/28701-BMR 619 Rev.A November 2017

© Flex

Thermal Consideration continued

Definition of reference temperature (T_{ref})

The reference temperature is used to monitor the temperature limits of the product. Temperatures above maximum T_{ref} are not allowed and may cause degradation or permanent damage to the product. T_{ref} is also used to define the temperature range for normal operating conditions. T_{ref} is defined by the design and used to guarantee safety margins, proper operation and high reliability of the module.

Ambient Temperature Calculation

By using the thermal resistance the maximum allowed ambient temperature can be calculated.

- The power loss is calculated by using the formula $((1/\eta) - 1) \times \text{output power} = \text{power losses (Pd)}$.
 η = efficiency of regulator. E.g 88 % = 0.88
- Find the thermal resistance (Rth) in the Thermal Resistance graph found in the Output section for each model. Calculate the temperature increase (ΔT).
 $\Delta T = R_{th} \times P_d$
- Max allowed ambient temperature is:
 $\text{Max } T_{ref} - \Delta T$.

E.g 5 V output at 1 m/s, full load, 12 V_{in} :

- $((\frac{1}{0.948}) - 1) \times 50 \text{ W} = 2.74 \text{ W}$
- $2.74 \text{ W} \times 10.0^\circ\text{C/W} = 27.4^\circ\text{C}$
- $115^\circ\text{C} - 27.4^\circ\text{C} = \text{max ambient temperature is } 87.6^\circ\text{C}$

The actual temperature will be dependent on several factors such as the PCB size, number of layers and direction of airflow.

Connections

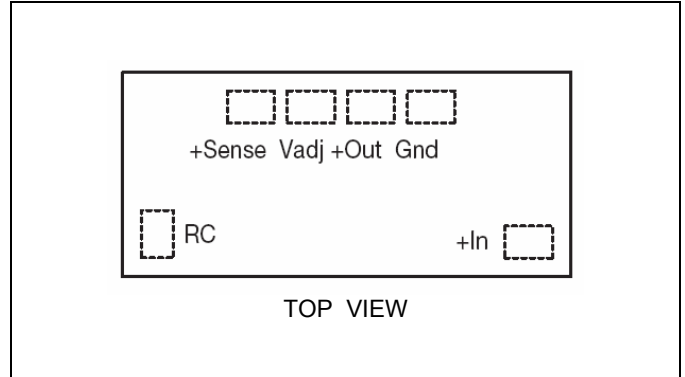

Pin	Designation	Function
1	RC	Remote Control
2	+In	Positive input
3	Gnd	Ground
4	+Out	Positive output
5	Vadj	External output adjust
6	+Sense	Positive remote sense

PMC 8518 series PoL Regulators
 Input 8.3 -16 V, Output up to 10 A / 50 W

2/28701-BMR 619 Rev.A November 2017

© Flex

Mechanical Information

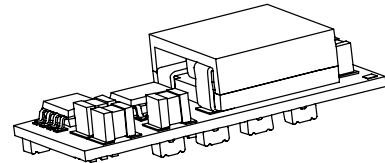
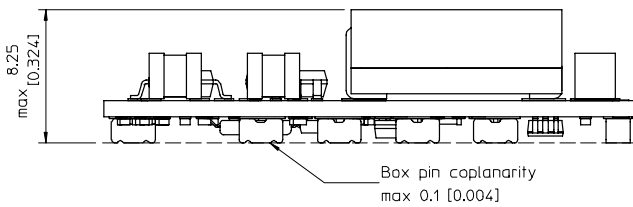
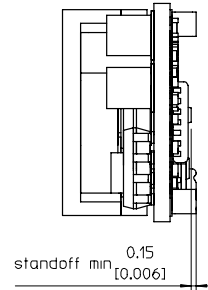
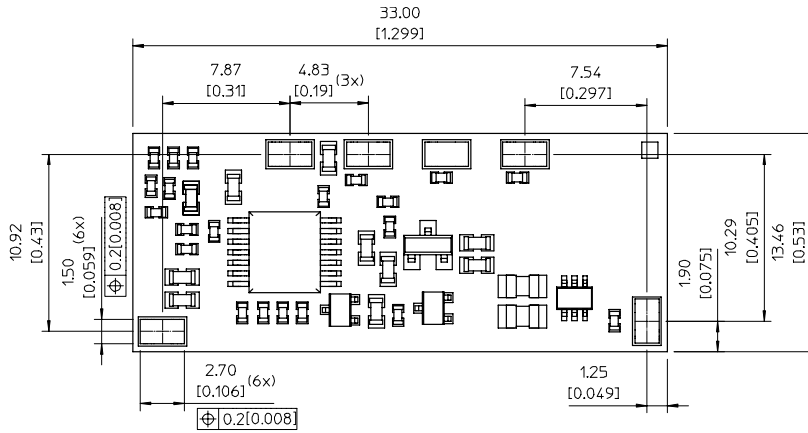

**RECOMMENDED FOOTPRINT
 TOP VIEW**

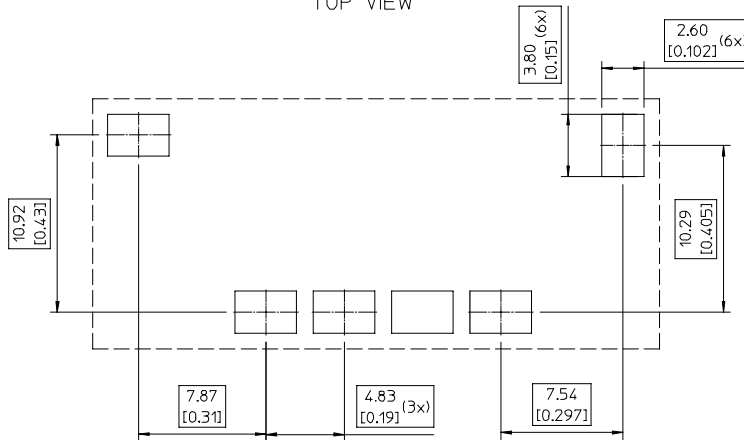

Pins:
 Material: Copper alloy
 Plating: 0.1 μm Au over 2 μm Ni

Weight: 7 g typical

All dimensions in mm [inch].
 Tolerances unless specified

x.x mm ±0.5 mm [0.02]

x.xx mm ±0.25 mm [0.01]

(not applied on footprint or typical values)



PMC 8518 series PoL Regulators
 Input 8.3 -16 V, Output up to 10 A / 50 W

2/28701-BMR 619 Rev.A November 2017
 © Flex

Soldering Information - Surface Mounting

The product is intended for convection or vapor phase reflow SnPb or Pb-free processes. To achieve a good and reliable soldering result, make sure to follow the recommendations from the solder paste supplier, to use state-of-the-art reflow equipment and reflow profiling techniques as well as the following guidelines.

A no-clean flux is recommended to avoid entrapment of cleaning fluids in cavities inside the product or between the product and the host board. The cleaning residues may affect long time reliability and isolation voltage.

Minimum Pin Temperature Recommendations

Pin number 4 is chosen as reference location for the minimum pin temperature recommendations since this will likely be the coolest solder joint during the reflow process.

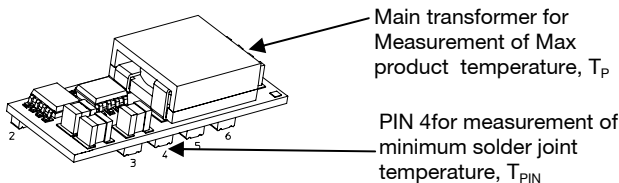

SnPb solder processes

For Pb solder processes, a pin temperature (T_{PIN}) in excess of the solder melting temperature, (T_L , +183°C for Sn63/Pb37) for more than 30 seconds, and a peak temperature of +210°C is recommended to ensure a reliable solder joint.

Lead-free (Pb-free) solder processes

For Pb-free solder processes, a pin temperature (T_{PIN}) in excess of the solder melting temperature (T_L , +217 to +221 °C for Sn/Ag/Cu solder alloys) for more than 30 seconds, and a peak temperature of +235°C on all solder joints is recommended to ensure a reliable solder joint.

Main transformer is chosen as reference location for the maximum (peak) allowed product temperature since this will likely be the warmest parts of the product during the reflow process.

To avoid damage or performance degradation of the product, the reflow profile should be optimized to avoid excessive heating. A sufficiently extended preheat time is recommended to ensure an even temperature across the host PCB, for both small and large devices. To reduce the risk of excessive heating is also recommended to reduce the time in the reflow zone as much as possible.

SnPb solder processes

For conventional SnPb solder processes, the product is qualified for MSL 1 according to IPC/JEDEC standard J-STD-020C.

During reflow, T_P must not exceed +225 °C at any time.

Lead-free (Pb-free) solder processes

For Pb-free solder processes, the product is qualified for MSL 1 according to IPC/JEDEC standard J-STD-020C.

During reflow, T_P must not exceed +245 °C at any time.

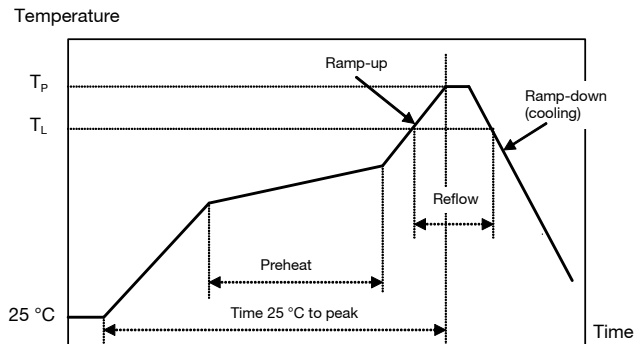

Profile features		Sn/Pb eutectic assembly	Pb-free assembly
Average ramp-up rate		3 °C/s max	3 °C/s max
Solder melting temperature (typical)	T_L	+183 °C	+217 °C
Peak product temperature	T_P	+225 °C ¹	+245 °C
Average ramp-down rate		6 °C/s max	6 °C/s max
Time 25 °C to peak temperature		6 minutes max	8 minutes max

Peak Product Temperature Requirements

PMC 8518 series PoL Regulators
 Input 8.3 -16 V, Output up to 10 A / 50 W

2/28701-BMR 619 Rev.A November 2017

© Flex

Delivery Package Information

The products are delivered in antistatic carrier tape (EIA 481 standard).

Carrier Tape Specifications	
Material	Dissipative polystyrene (PS)
Surface resistance	Ohm/square < 10 ⁵
Bak	The tape is not bake
Tape width	44 mm [1.732 inch]
Pocket pitch	24 mm [0.945 inch]
Pocket depth	8.6 mm [0.339 inch]
Reel diameter	330 mm [13 inch]
Reel capacity	200 products /reel
Reel weight	1.9 kg/full reel (typical)

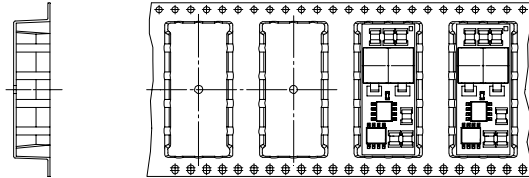

PMC 8518 series PoL Regulators
Input 8.3 -16 V, Output up to 10 A / 50 W

2/28701-BMR 619 Rev.A November 2017

© Flex

Product Qualification Specification

Characteristics			
External visual inspection	IPC-A-610D		
Change of temperature (Temperature cycling)	JESD22-A104-B	Temperature range Number of cycles Dwell/transfer time	-40 to +125 °C 300 30 min/0-1 min
Cold (in operation)	IEC 68-2-1 Ad	Temperature T _A Duration	-45 °C 72 h
Damp heat	JESD22-A101-B	Temperature Humidity Duration	+85 °C 85 % RH 1000 hours
Dry heat	JESD22-A103-B	Temperature Duration	+125 °C 1000 h
Mechanical shock	JESD22-B104-B	Peak acceleration Duration	200 g 1.5 ms
Moisture reflow sensitivity classification	J-STD-020C	SnPb Eutectic Pb free	MSL 1, peak reflow @ 225 °C MSL 1, peak reflow @ 245 °C
Operational life test		Ambient temperature Load Maximum input voltage ON Input voltage OFF Duration	85 °C Nominal 9 min 3 min 1000 h
Lead integrity	JESD22-B105-C	Weight on all terminals	1000 g
Random vibration	JESD22-B103-B	Frequency Acceleration density	2-500 Hz 0.008-0.2 g ² / Hz
Solderability	IEC 68-2-58 Td	Solder immersion depth Time for onset of wetting Wetting force	1 mm < 4 s > 100 mN / m
Sinusoidal vibration	JESD22-B103-B	Frequency Acceleration amplitude	10.....1000 Hz 10 g