

# PLCC4 SMD Top View Package LED SMP4-BC, RED/GREEN

# BIVAR

## SMP4-BC

- ◆ Industry Standard PLCC4 Footprint
- ◆ 2 Chips in One Low Profile Package
- ◆ High Luminous Intensity
- ◆ Wide Viewing Angle
- ◆ High Power Efficiency



Bivar SMP4 Bi-Color LED combines two chips in a single package and is offered in an industry standard PLCC4 footprint. The SMP4 LED has a water clear lens for high luminous intensity and wide viewing angle making them ideal for small scale applications such as illumination, general indication, and backlighting. The robust package is ideal for harsh working environments and can be clustered in LED arrays for high luminous applications. Low power consumption and excellent long life reliability are suitable for battery powered equipment. Bivar SMP4 LED is packaged in standard tape and reels for pick and place assemblies.

Part Number	Material	Emitted Color	Lumen Typ. mcd	Lens Color	Viewing Angle
SMP4-BC	AlGaAs	Red	36	Water Clear	120°
	GaP	Green	40		

## Outline Dimensions

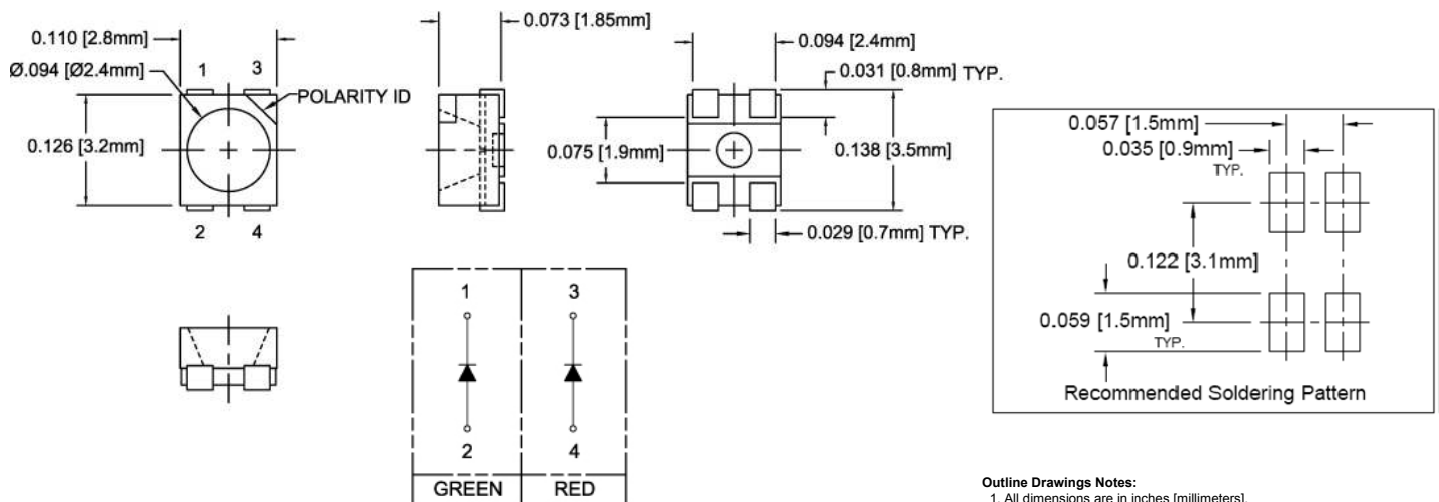

Bivar reserves the right to make changes at any time without notice.

# PLCC4 SMD Top View Package LED SMP4-BC, RED/GREEN



## Absolute Maximum Ratings

$T_A = 25^\circ\text{C}$  unless otherwise noted

Power Dissipation	72 mW
Continuous Forward Current	30 mA
Peak Forward Current <sup>1</sup>	100 mA
Reverse Voltage	5 V
Electrostatic Discharge Classification (HBM)	2000 V
Derating Linear From 25°C	0.4 mA/°C
Operating Temperature Range	-40 ~ +85°C
Storage Temperature Range	-40 ~ +100°C
Soldering Temperature <sup>2</sup>	260°C

Notes: 1. 10% Duty Cycle, Pulse Width  $\leq 0.1$  msec.  
2. Solder time less than 5 seconds at temperature extreme.

## Electrical Characteristics

$T_A = 25^\circ\text{C}$  &  $I_F = 20$  mA unless otherwise noted

Emitting Color	Forward Voltage (V) <sup>1</sup>		Recommend Forward Current (mA)	Reverse Current ( $\mu\text{A}$ ) $V_R=5\text{V}$	Dominant Wavelength (nm) <sup>2</sup>	Luminous Intensity (mcd) <sup>3</sup>		Viewing Angle $2\theta_{1/2}$ (deg)
	TYP	MAX	TYP	MAX	TYP	MIN	TYP	TYP
Red	1.85	2.3	20	10	640	18	36	120
Green	1.9	2.4	20	10	570	20	40	

Notes: 1. Tolerance of Forward Voltage :  $\pm 0.05\text{V}$ .  
2. Tolerance of Dominant Wavelength :  $\pm 0.1\text{nm}$ .  
3. Tolerance of Luminous Intensity :  $\pm 15\%$ .

## Directivity Radiation

$T_A = 25^\circ\text{C}$  unless otherwise noted

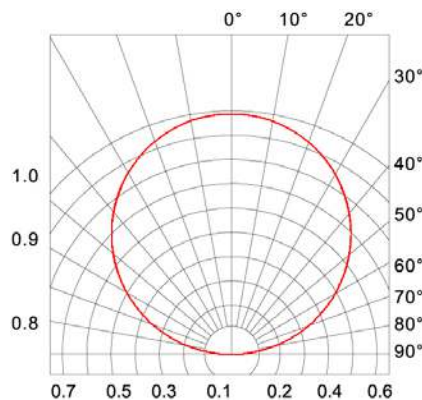

Radiation Diagram

Bivar reserves the right to make changes at any time without notice.

# PLCC4 SMD Top View Package LED SMP4-BC, RED/GREEN



## Typical Electrical / Optical Characteristics Curves

$T_A = 25^\circ\text{C}$  unless otherwise noted

Relative Spectrum Emission  $I_{rel} = f(\lambda)$ ,  $T_A = 25^\circ\text{C}$ ,  $I_F = 20\text{ mA}$   
 $V(\lambda) = \text{Standard eye response curve}$

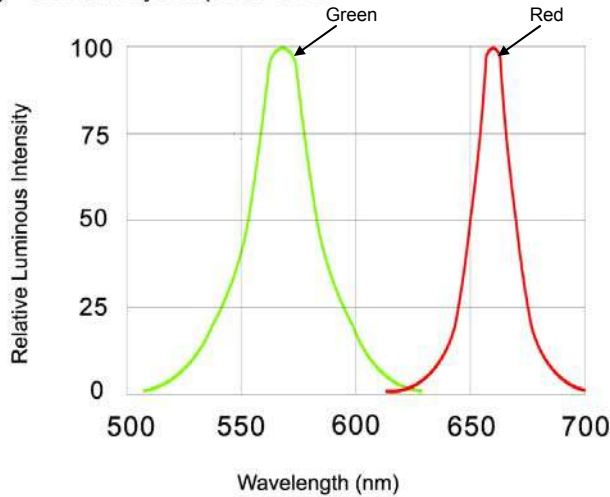

Fig.1 Relative Luminous Intensity vs. Wavelength

Forward Current  $I_F = f(V_F)$   
 $T_A = 25^\circ\text{C}$

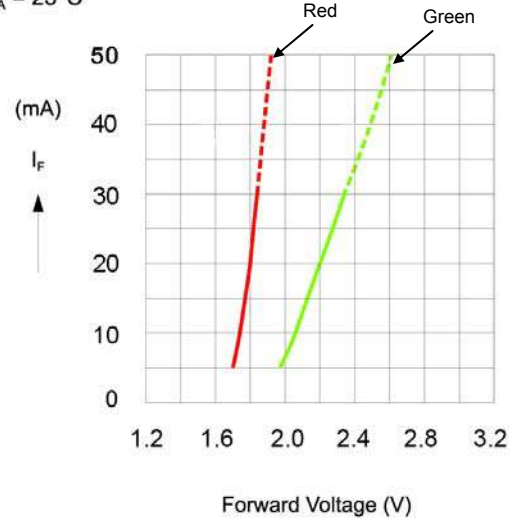

Fig.2 Forward Current vs. Forward Voltage

Relative Luminous Intensity  $I_V/I_V(20\text{ mA}) = f(I_F)$   
 $T_A = 25^\circ\text{C}$

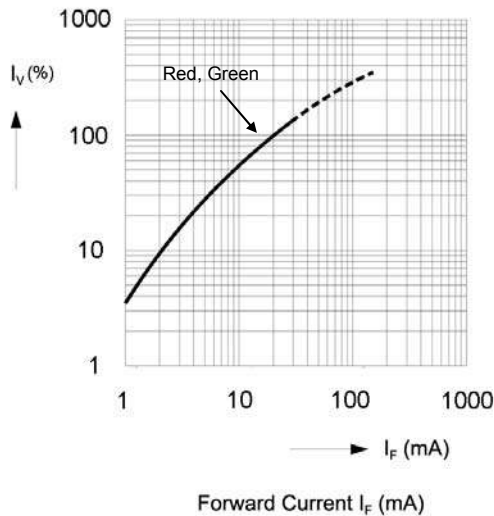

Fig.3 Relative Luminous Intensity vs. Forward Current

Ambient Temperature vs. Allowable Forward Current

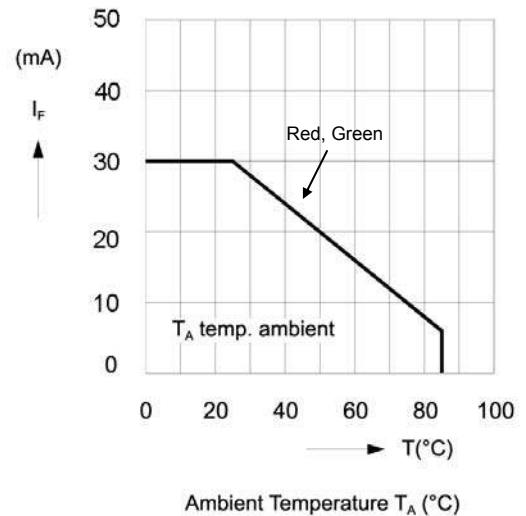

Fig.4 Forward Current vs. Ambient Temperature

Bivar reserves the right to make changes at any time without notice.

# PLCC4 SMD Top View Package LED SMP4-BC, RED/GREEN



## Recommended Soldering Conditions

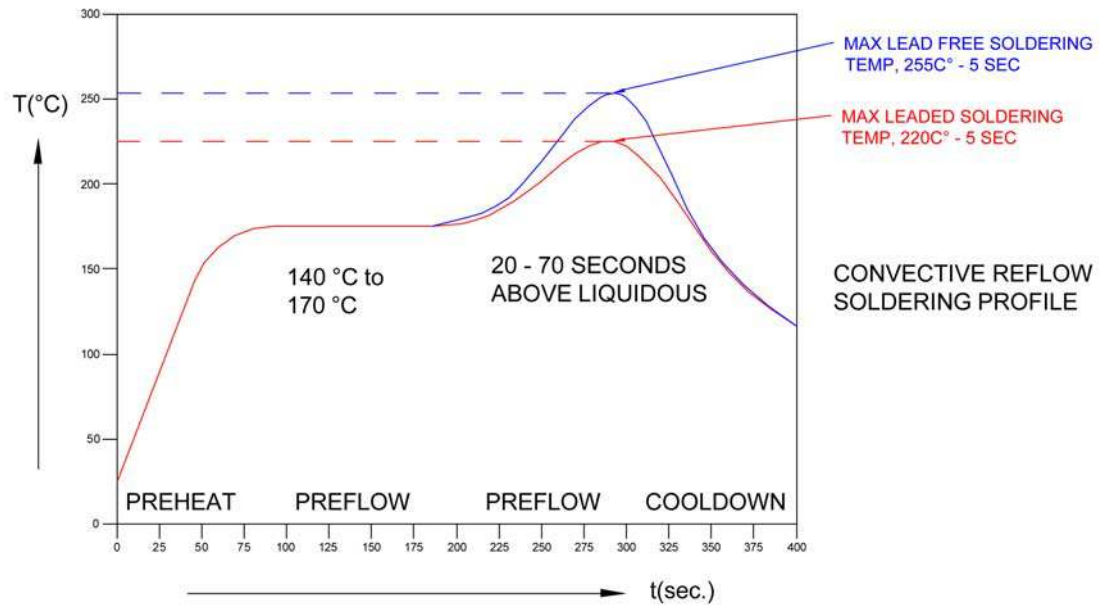

## Tape and Reel Dimensions

Note: 2000 pcs/Reel

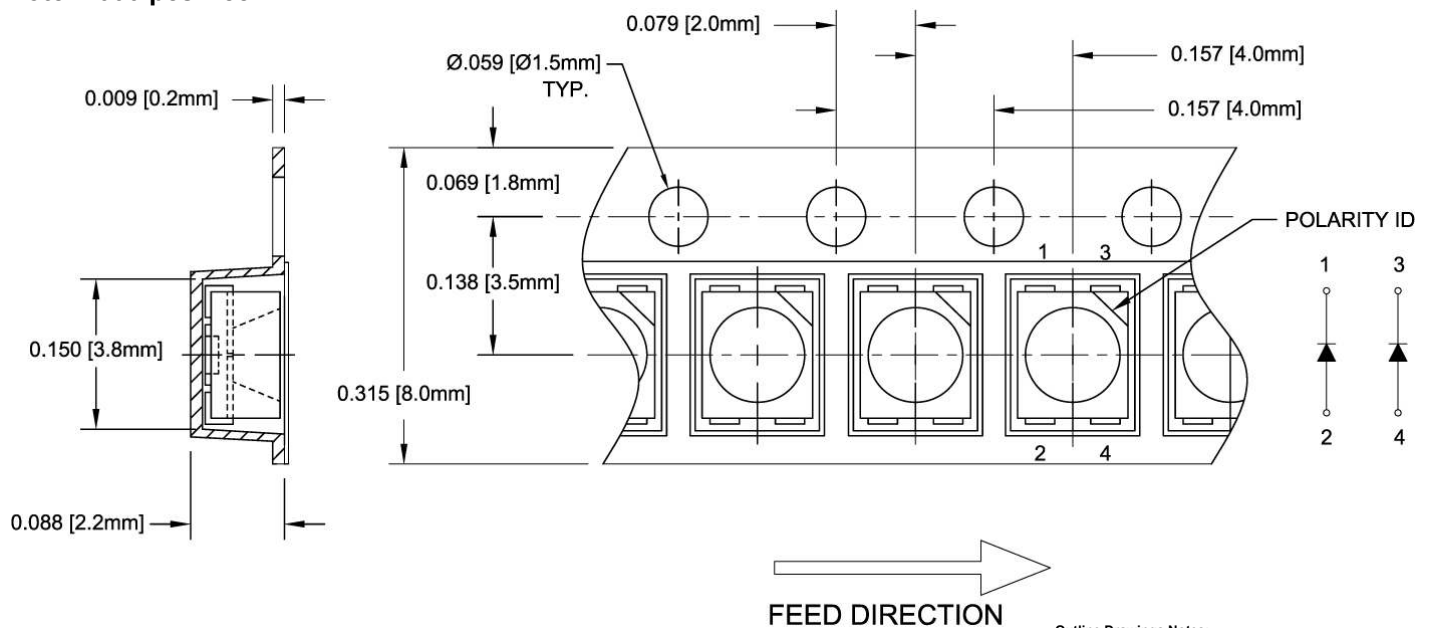

Outline Drawings Notes:  
 1. All dimensions are in inches [millimeters].  
 2. Standard tolerance:  $\pm 0.010$  unless otherwise noted.

Bivar reserves the right to make changes at any time without notice.

# PLCC4 SMD Top View Package LED SMP4-BC, RED/GREEN



### Outline Drawings Notes:

1. All dimensions are in inches [millimeters].
2. Standard tolerance unless otherwise noted: X.XXX ± 0.010"  
X.X ± 0.1"

## Packaging and Labeling Plan

Note: 1 Reel / Bag

Sealed ESD and Moisture Barrier Bag

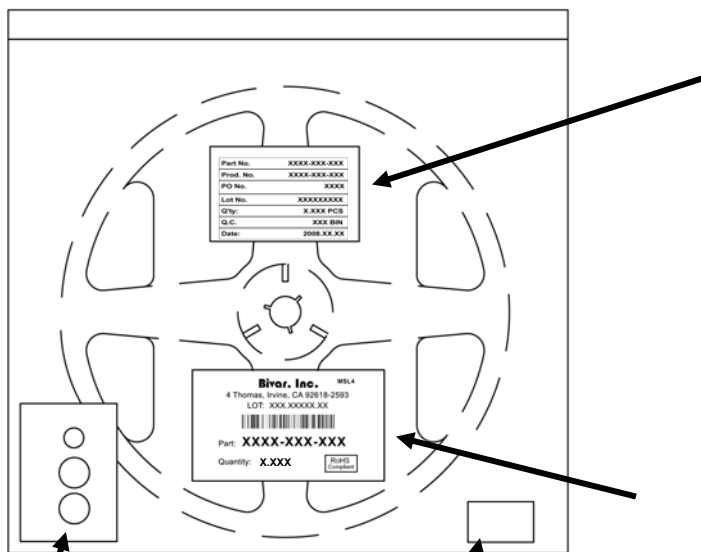

Humidity Indicator Card

Desiccant Card

Part No.	XXXX-XXX-XXX
Prod. No.	XXXX-XXX-XXX
PO No.	XXXX
Lot No.	XXXXXXXXXX
Q'ty:	X.XXX PCS
Q.C.	XXX BIN
Date:	2008.XX.XX

Internal Quality Control Label



Bivar Standard Packaging Label

Bivar reserves the right to make changes at any time without notice.