

**SPECIFICATION** **CS85BGT2C**
**PACKAGE OUTLINES**

**Recommended Solder Pad**

- Notes:
1. All dimensions are in millimeters (inches).
  2. Tolerance is  $\pm 0.25\text{mm}$  (0.01") unless otherwise noted.
  3. Specifications are subject to change without notice.

Part Number	Chip Material	Color of Emission	Lens Type	Viewing Angle
CS85BGT2C	InGaN	Pure Green	Water Clear	130°

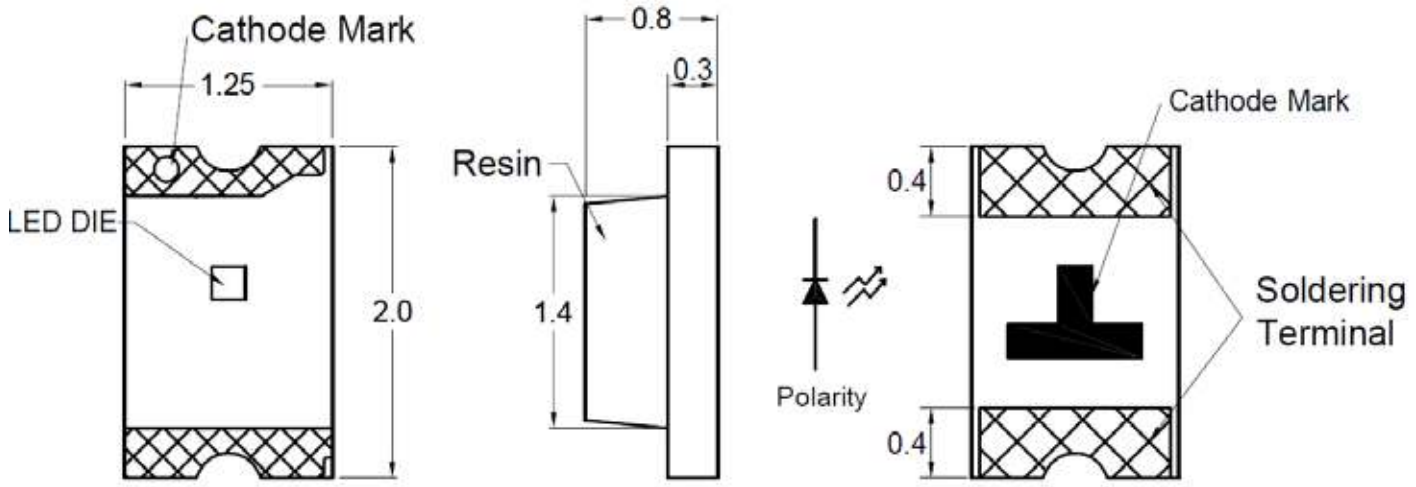
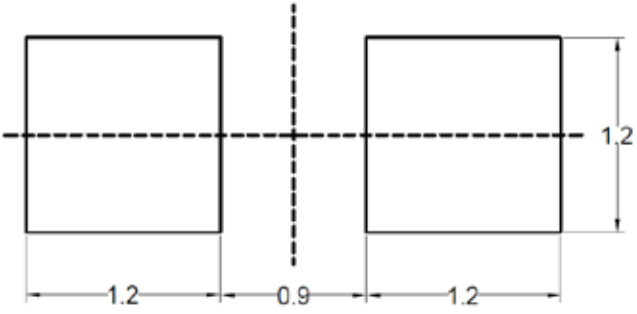

ChromeLED Corp. reserves the right to make changes at any time in order to supply the best product possible. The most current version of this document will always be available at: [www.chromeled.com](http://www.chromeled.com)

**ABSOLUTE MAXIMUM RATINGS**
**(TA=25°C)**

Parameter	Symbol	Max Rating	Unit
Forward Current	IF	20	mA
Reverse Current @ 5V	IR	10	μA
Power Dissipation	Pd	80	mW
Operating Temperature Range	TOP	-40~+80	°C
Storage Temperature Range	TSTG	-40~+90	°C
Peak Pulsing Current (1/10 duty f = 10KHz)	IFP	100	mA
Soldering Temperature	TSOL	Max 260°C for 5 sec Max	

**OPTICAL-ELECTRICAL CHARACTERISTICS**
**(TA=25°C)**

Parameter	Symbol	Test Condition	Value			Unit
			Min	Typ	Max	
Luminous Intensity	Iv	IF = 20mA	125	250	-	mcd
Forward Voltage	VF	IF = 20mA	-	3.5	4.0	V
Reverse Leakage Current	IR	VR = 5V	-	-	10	μA
Viewing Angle at 50% Iv	2θ1/2	IF = 20mA	-	130	-	Deg
Peak Wavelength	λP	IF = 20mA	-	518	-	nm
Dominant Wavelength	λD	IF = 20mA	-	525	-	nm

\*Tolerance of viewing angle: -10 / +5 deg.



ChromeLED Corp. reserves the right to make changes at any time in order to supply the best product possible. The most current version of this document will always be available at: [www.chromeled.com](http://www.chromeled.com)

## OPTICAL CHARACTERISTIC CURVES

Fig.1 Forward current vs. Forward Voltage

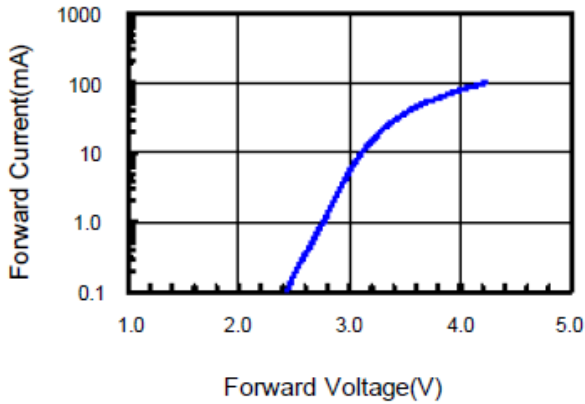

Fig.2 Relative Intensity vs. Forward Current

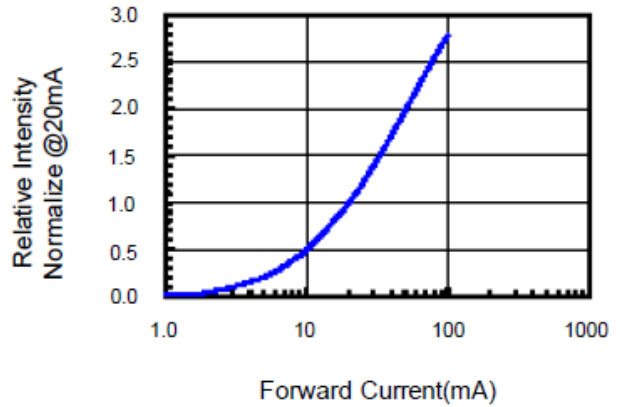

Fig.3 Forward Voltage vs. Temperature

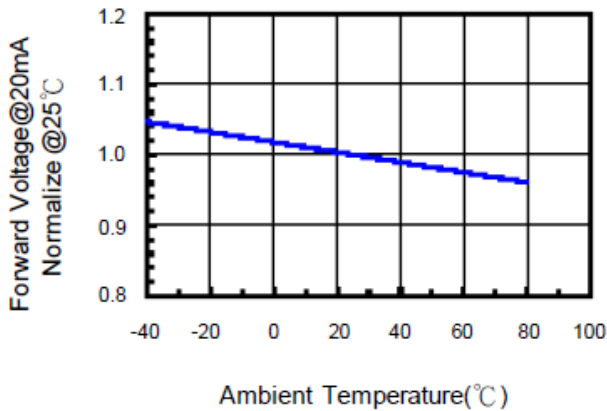

Fig.4 Relative Intensity vs. Temperature

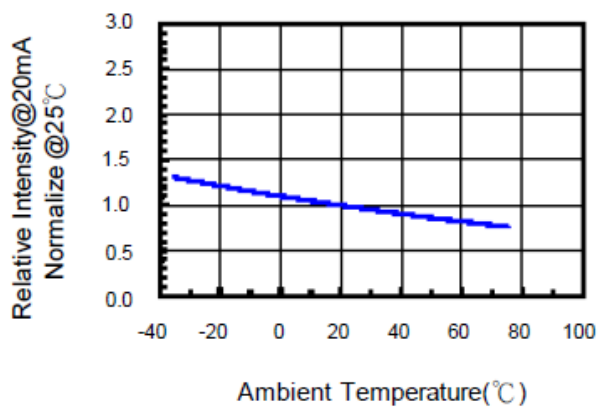

Fig.5 Relative Intensity vs. Wavelength

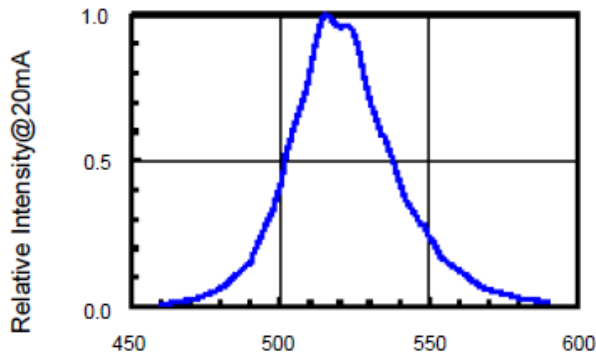
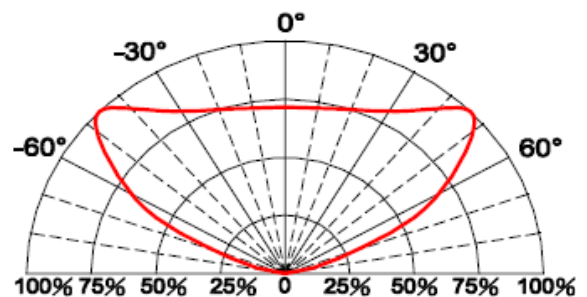
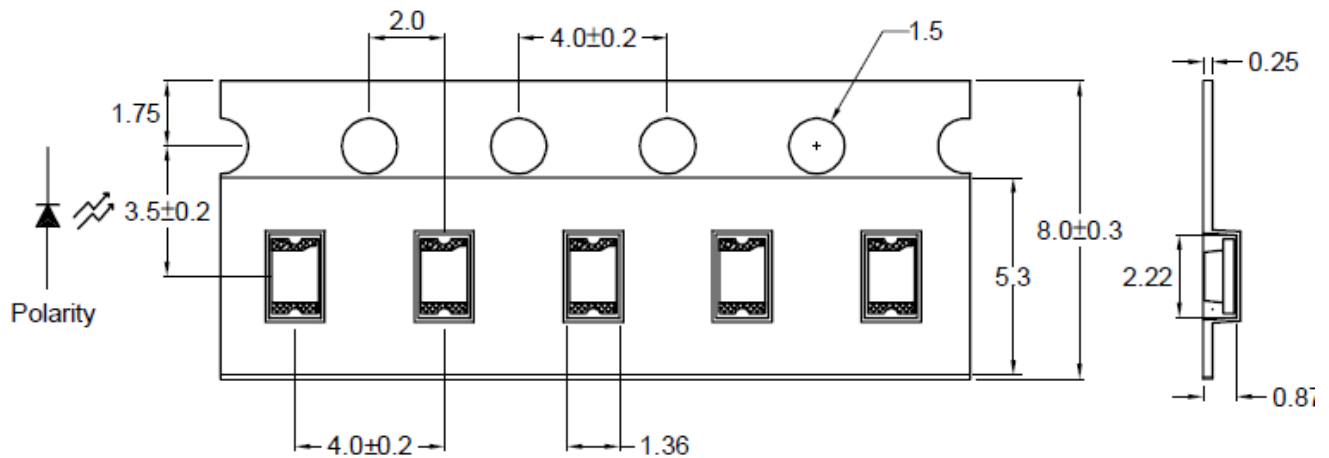

Fig.6 Directive Radiation



ChromeLED Corp. reserves the right to make changes at any time in order to supply the best product possible. The most current version of this document will always be available at: [www.chromeled.com](http://www.chromeled.com)

**PACKAGING SPECIFICATION**
**Dimensions of Tape (Unit: mm)**

Note : The tolerances unless mentioned is  $\pm 0.1\text{mm}$ , Angle  $\pm 0.5$ . Unit=mm.

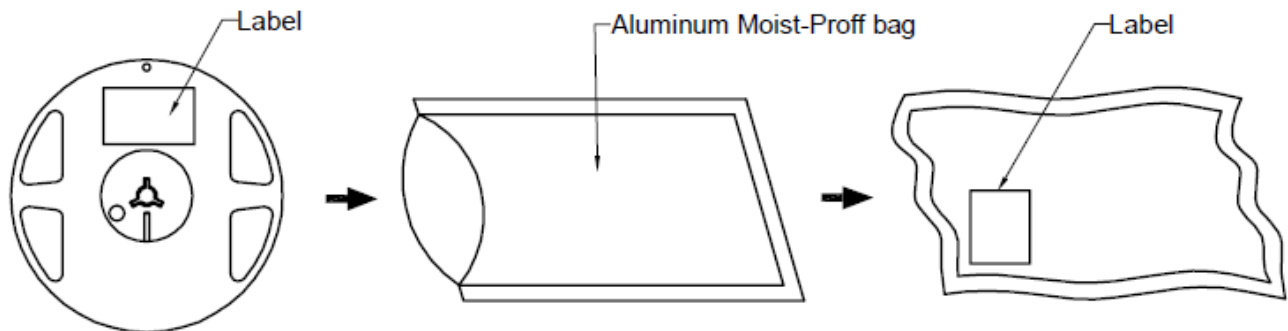
**PACKAGING SPECIFICATION**

**Notes:**

1. Empty component pockets are sealed with top cover tape;
2. The maximum number of missing lamps is two;
3. The cathode is oriented towards the tape sprocket hole.
4. 4,000pcs/Reel



ChromeLED Corp. reserves the right to make changes at any time in order to supply the best product possible. The most current version of this document will always be available at: [www.chromeled.com](http://www.chromeled.com)

## SOLDERING CONDITIONS

### 1. Hand Solder

Basic spec is  $\leq 280^{\circ}\text{C}$  3 sec one time only.

### 2. Wave Solder

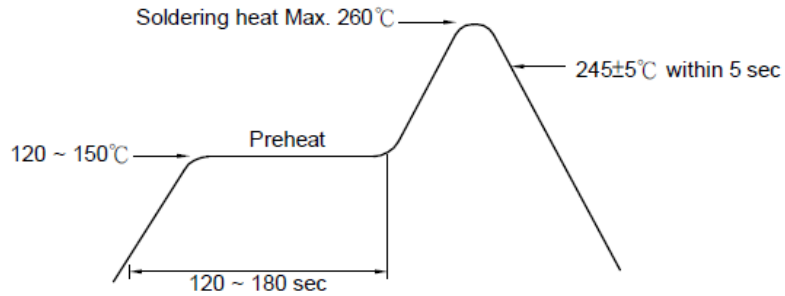

### 3-1. LEAD Reflow Solder

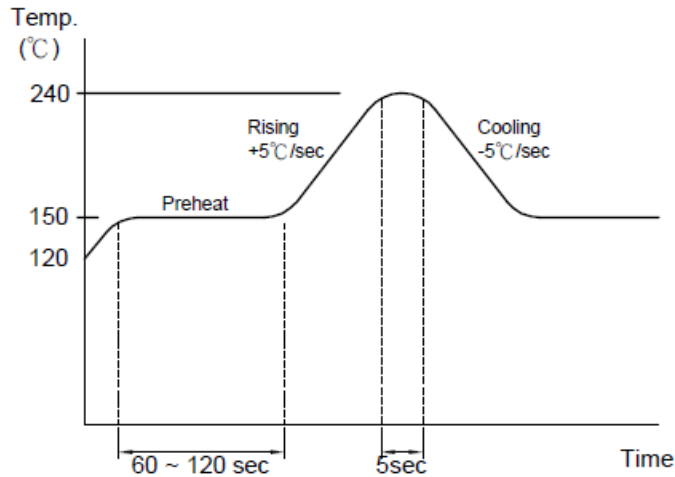

### 3-2 PB-Free Reflow Solder

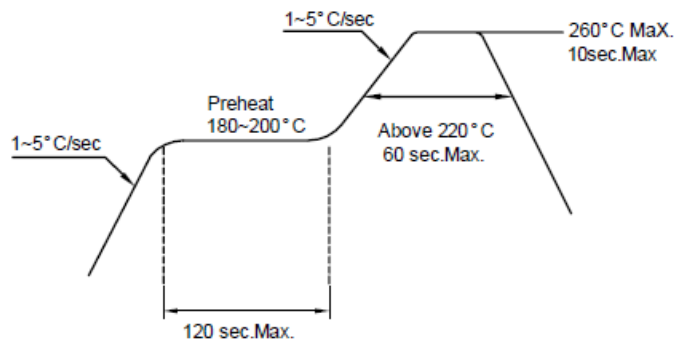

Reflow Soldering should not be done more than two times.



ChromeLED Corp. reserves the right to make changes at any time in order to supply the best product possible. The most current version of this document will always be available at: [www.chromeled.com](http://www.chromeled.com)