

Features

- Broad Bandwidth
- Specified from 50 MHz to 20.0 GHz
- Usable from 50 MHz to 26.5 GHz
- Lower Insertion Loss / Higher Isolation
- Fully Monolithic, Glass Encapsulated Chip
- Up to +33 dBm CW Power Handling @ +25°C
- RoHS* Compliant

Description

The MASW-004100-1193 is a SP4T, series-shunt, broadband, PIN diode switch made with MACOM's patented HMIC™ (Heterolithic Microwave Integrated Circuit) process. This process allows the silicon pedestals which form the series - shunt diodes and vias to be embedded into low loss, low dispersion glass. By incorporating small spacing between circuit elements, the result is an HMIC chip with low insertion loss and high isolation at frequencies up to 26.5 GHz. It is designed to be used as a moderate power, high performance switch and provide superior performance when compared to similar designs that use discrete components.

The top side of the chip is protected by a polymer coating for manual or automatic handling and large gold bond pads help facilitate connection of low inductance ribbons. The gold metallization on the backside of the chip allows for attachment via 80/20, gold/tin solder or conductive silver epoxy.

The MASW-004100-1193 is a high performance switch suitable for use in multi-band ECM, radar, and instrumentation control circuits where high isolation to insertion loss ratios are required. With a standard ± 5 V, TTL controlled, PIN diode driver, 50 ns switching speeds are achievable.

Functional Diagrams

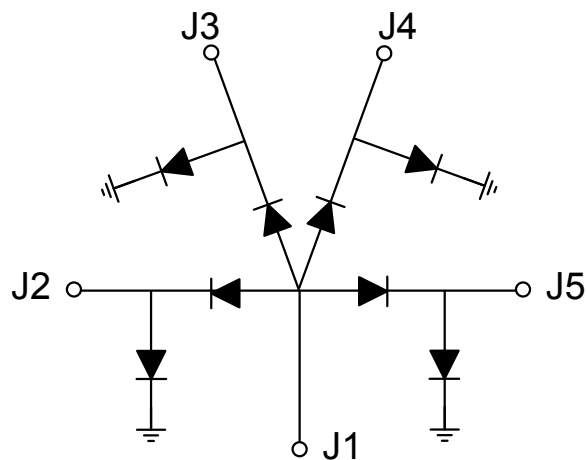
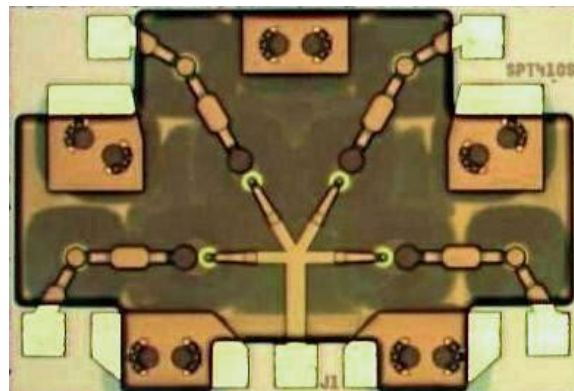

Ordering Information

Part Number	Package xx = 0G	Package xx = 0W
MASW-004100-1193(xx)	Gel Pack	Waffle Pack

*Restrictions on Hazardous Substances, European Union Directive 2011/65/EU.

Electrical Specifications: $T_A = 25^\circ\text{C}$, 20 mA (On-Wafer Measurements)

Parameter	Test Conditions	Units	Min.	Typ.	Max.
Insertion Loss	20 GHz	dB	—	0.9	1.3
Isolation	20 GHz	dB	28	34	—
Input Return Loss	20 GHz	dB	—	15	—
Output Return Loss	20 GHz	dB	—	15	—
Switching Speed ¹	10 GHz	ns	—	50	—

1. Typical switching speed is measured from (10% to 90% and 90% to 10% of detected RF voltage), driven by TTL compatible drivers. In the modulating state, (the switching port is modulating, all other ports are in steady state isolation.) The switching speed is measured using an RC network using the following values: $R = 50 - 200 \Omega$, $C = 390 - 1000 \text{ pF}$. Driver spike current, $I_C = C \text{ dv/dt}$, ratio of spike current to steady state current, is typically 10:1.

Absolute Maximum Ratings^{2,3,4}

Parameter	Absolute Maximum
RF CW Incident Power	+33 dBm
Reverse Voltage	-25 V
Bias Current per Port	$\pm 50 \text{ mA @ } +25^\circ\text{C}$
Operating Temperature	$-65^\circ\text{C to } +125^\circ\text{C}$
Storage Temperature	$-65^\circ\text{C to } +150^\circ\text{C}$

- Exceeding any one or combination of these limits may cause permanent damage to this device.
- MACOM does not recommend sustained operation near these survivability limits.
- Maximum operating conditions for a combination of RF power, DC bias and temperature: +33 dBm CW @ 15 mA (per diode) @ $+85^\circ\text{C}$.

Handling Procedures

Please observe the following precautions to avoid damage:

Static Sensitivity

These electronic devices are sensitive to electrostatic discharge (ESD) and can be damaged by static electricity. Proper ESD control techniques should be used when handling these Class 0 (HBM) and Class C1 (CDM) devices.

Typical Performance Curves:

Insertion Loss vs. Frequency

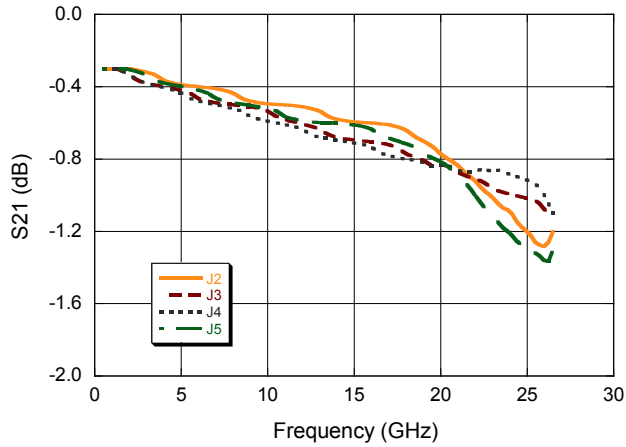

Isolation vs. Frequency

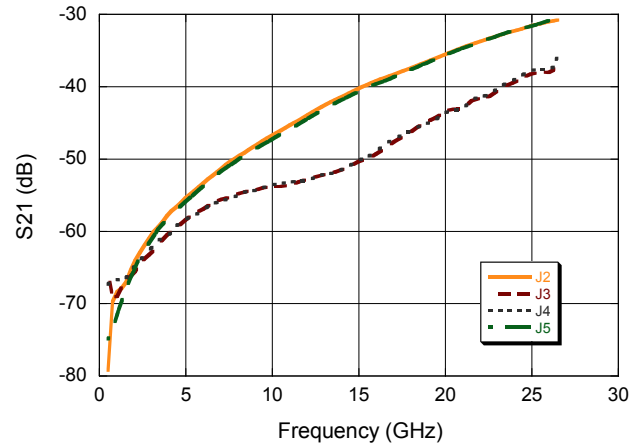

Input Return Loss vs. Frequency

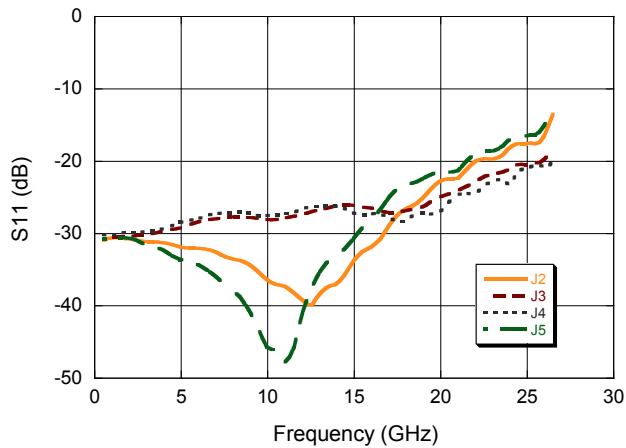

Output Return Loss vs. Frequency

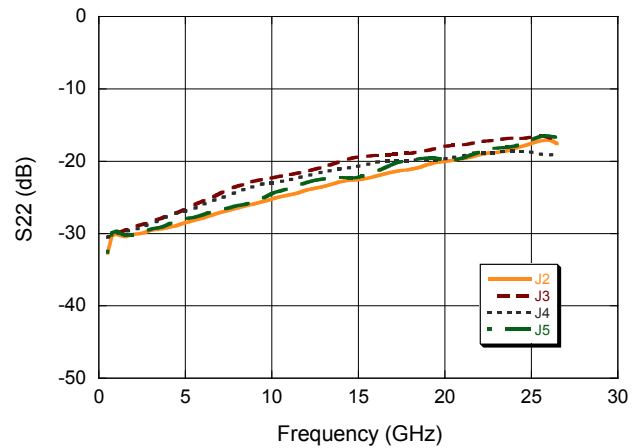

Operation of the MASW-004100-1193 PIN Switch

The simultaneous application of a negative DC current to the low loss port and positive DC current to the isolated ports as shown below in Fig.1 is required for proper operation of the switch. The backside area of the die is the RF and DC ground return and the DC return is through the common port J1. A constant current source should be used to supply the DC control currents. The control voltages at these points will not exceed ± 1.5 volts for supply currents up to ± 20 mA. In the low loss state, the series diode must be forward biased and the shunt diode reverse biased. On all isolated ports, the shunt diode is forward biased and the series diode is reverse biased. A typical bias network design that will produce >30 dB RF to DC isolation is shown below in Figure 1 .

The optimum insertion loss, P1dB, IP3, and switching speed are attained by using a voltage pull-up resistor in the DC return path, J1. A minimum value of $|-2V|$ is recommended using a standard, ± 5 V TTL controlled PIN driver such as MACOM's **MADR-009190-000100**.

Typical 2 - 18 GHz Bias Network

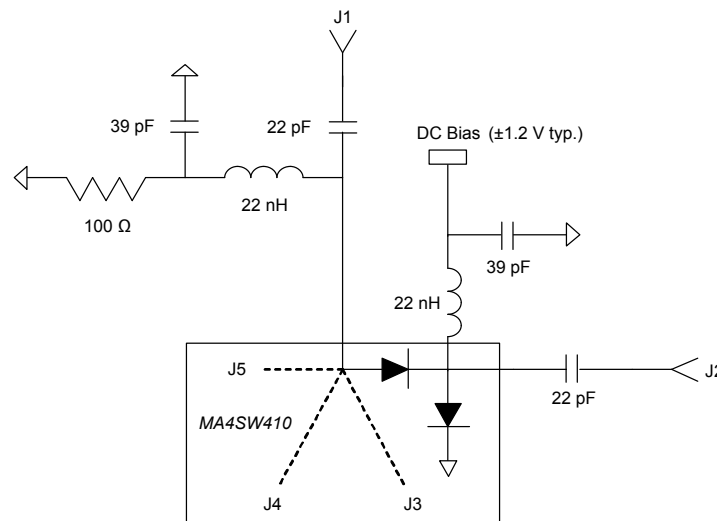

Fig. 1

Typical Driver Connections

DC Control Current (mA)				RF Output States			
J2	J3	J4	J5	J1-J2	J1-J3	J1-J4	J1-J5
-20	+20	+20	+20	low loss	Isolation	Isolation	Isolation
+20	-20	+20	+20	Isolation	low loss	Isolation	Isolation
+20	+20	-20	+20	Isolation	Isolation	low loss	Isolation
+20	+20	+20	-20	Isolation	Isolation	Isolation	low loss

Compatible MACOM Driver
MADR-009190-000100

MASW-004100-1193 Chip Dimensions^{5,6}

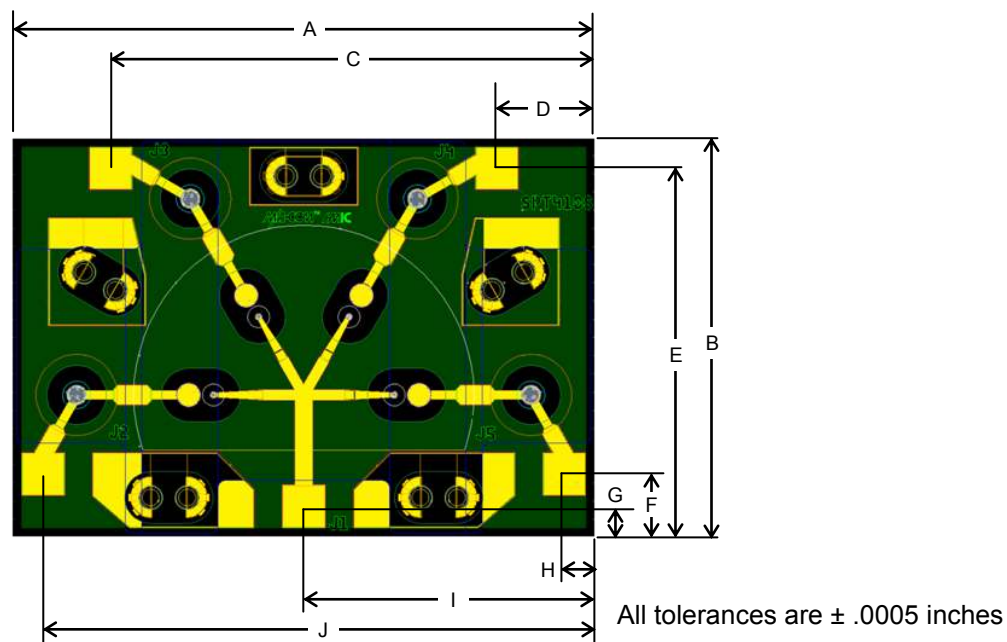

- 5. Topside and backside metallization is gold, 2.5 μm thick typical.
- 6. Yellow areas indicate wire bonding pads.

DIM	Nominal	
	inches	mm
A	0.066	1.67
B	0.047	1.19
C	0.054	1.37
D	0.012	0.31
E	0.043	1.08
F	0.009	0.22
G	0.004	0.11
H	0.004	0.11
I	0.033	0.84
J	0.061	1.56
Thickness	0.005	.120
Bond Pads	0.005 x 0.005	0.120 x 0.120

Cleanliness

The chips should be handled in a clean environment free of dust and organic contamination.

Wire / Ribbon Bonding

Thermo compression wedge bonding using 0.003" x 0.00025" ribbon or 0.001" diameter gold wire is recommended. A work stage temperature of 150°C - 200°C, tool tip temperature of 120°C - 150° and a downward force of 18 to 22 grams should be used. If ultrasonic energy is necessary, it should be adjusted to the minimum level required to achieve a good bond. Excessive power or force will fracture the silicon beneath the bond pad causing it to lift. RF bond wires and ribbons should be kept as short as possible for optimum RF performance.

Chip Mounting

HMIC switches have Ti-Pt-Au backside metallization and can be mounted using a gold-tin eutectic solder or conductive epoxy. Mounting surface must be free of contamination and flat.

Eutectic Die Attachment

An 80/20, gold-tin, eutectic solder is recommended. Adjust the work surface temperature to 255°C and the tool tip temperature to 265°C. After placing the chip onto the circuit board re-flow the solder by applying hot forming gas (95/5 Ni/H) to the top surface of the chip. Temperature should be approximately 290°C and not exceed 320°C for more than 20 seconds. Typically no more than three seconds is necessary for attachment. Solders rich in tin should be avoided

Epoxy Die Attachment

A minimum amount of epoxy, 1 - 2 mils thick, should be used to attach chip. A thin epoxy fillet should be visible around the outer perimeter of the chip after placement. Epoxy cure time is typically 1 hour at 150°C.