

## GaAs MMIC SMT DOUBLE-BALANCED MIXER, 6 - 15 GHz

### Typical Applications

The HMC142C8 is ideal for:

- Microwave Point-to-Point Radios
- VSAT Ground Equipment

### Features

- Input IP3: 20 dBm
- Conversion Loss: 8.5 dB
- LO to RF Isolation: 35 dB

### Functional Diagram

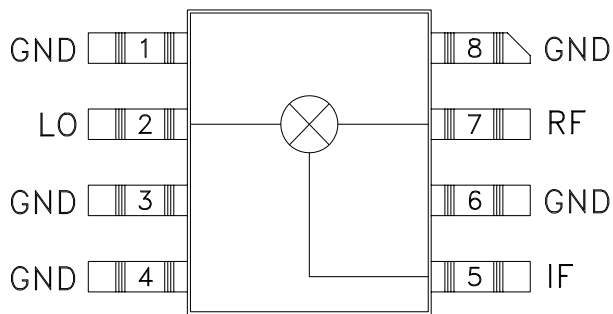

### General Description

The HMC142C8 is a miniature double-balanced mixer in a non-hermetic ceramic surface mount package that can be used as an upconverter or downconverter. The device is a passive diode/balun type mixer with high dynamic range. The mixer can handle larger signal levels than most active mixers due to the high third order intercept. MMIC implementation provides exceptional balance in the circuit resulting in high LO/RF and LO/IF isolations and unit-to-unit consistency. This mixer has applications where small size and surface mount compatibility are important.

### Electrical Specifications, $T_A = +25^\circ \text{C}$ , LO Drive = +15 dBm

Parameter	Min.	Typ.	Max.	Units
Frequency Range, RF & LO	6 - 15			GHz
Frequency Range, IF	DC - 2			GHz
Conversion Loss	7 - 11 GHz	8.5	10	dB
	6 - 18 GHz	10	12	dB
Noise Figure (SSB)		8.5	10	dB
LO to RF Isolation	28	35		dB
LO to IF Isolation	17	25		dB
IP3 (Input)		20		dBm
IP2 (Input)		45		dBm
1 dB Gain Compression (Input)		10		dBm

## GaAs MMIC SMT DOUBLE-BALANCED MIXER, 6 - 15 GHz

### Conversion Loss

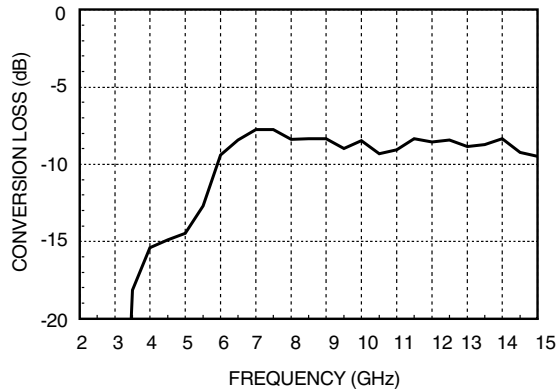

### Isolation

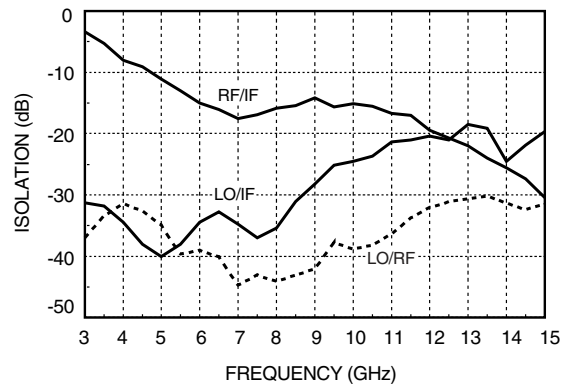

### Conversion Loss vs. LO Drive Level

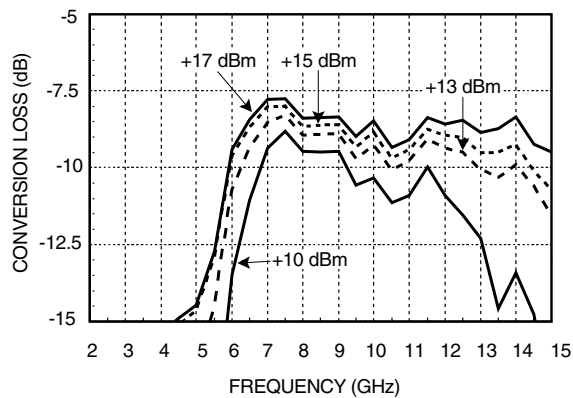

### Isolation vs. LO Drive Level

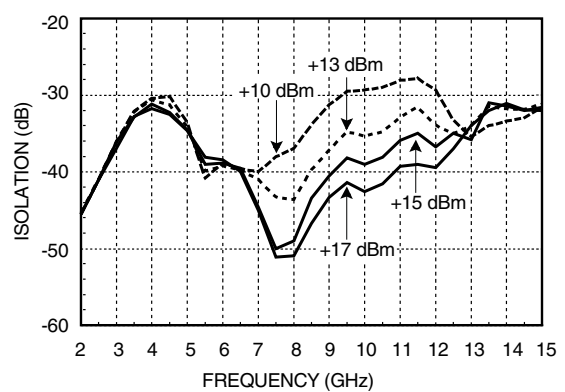

### Return Loss

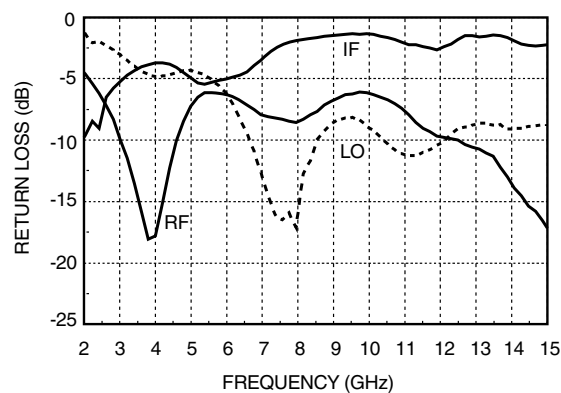

### Distortion and 1dB

#### Compression vs. LO Drive Level

LO Drive (dBm)	Distortion		1 dB Compression P1dB (dBm)
	IP3 (dBm)	IP2 (dBm)	
+13	18	42	7
+15	21	45	10
+17	21	45	10

**Absolute Maximum Ratings**

RF/IF Input	+13 dBm
LO Drive	+27 dBm
Storage Temperature	-65 to +150 °C
Operating Temperature	-55 to +85 °C

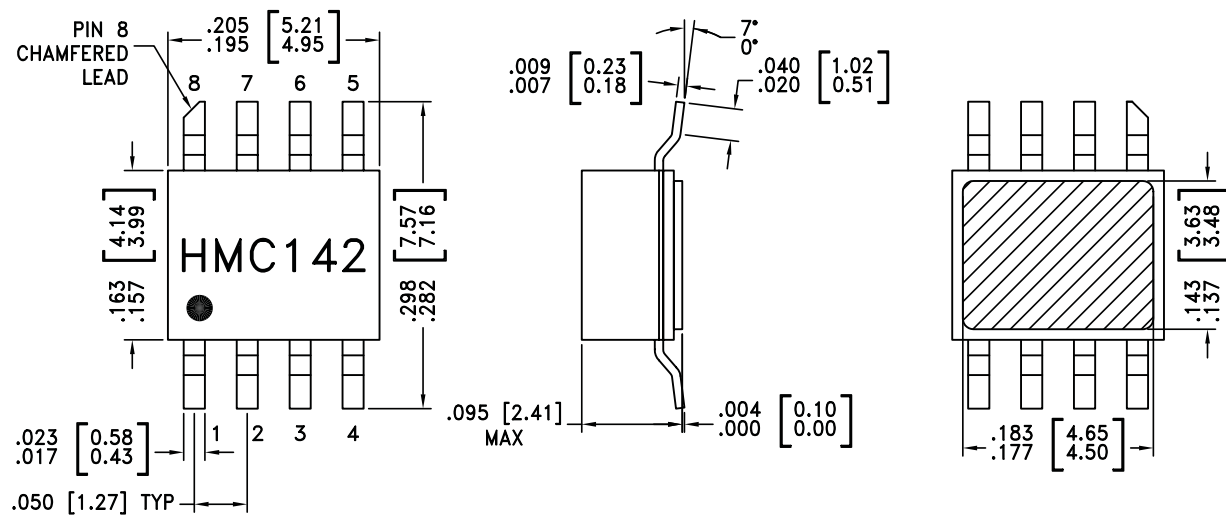

ELECTROSTATIC SENSITIVE DEVICE  
OBSERVE HANDLING PRECAUTIONS

**Outline Drawing**

**NOTES:**

1. PACKAGE BODY MATERIAL: WHITE ALUMINA 92%
2. LEAD, PACKAGE BOTTOM MATERIAL: COPPER
3. PLATING: ELECTROLYTIC GOLD 100-200 MICROINCHES, OVER ELECTROLYTIC NICKEL 100-250 MICROINCHES.
4. DIMENSIONS ARE IN INCHES [MILLIMETERS].
5. PACKAGE LENGTH AND WIDTH DIMENSIONS DO NOT INCLUDE LID SEAL PROTRUSION .005 PER SIDE.
6. ALL GROUND LEADS AND GROUND PADDLE MUST BE SOLDERED TO PCB RF GROUND.

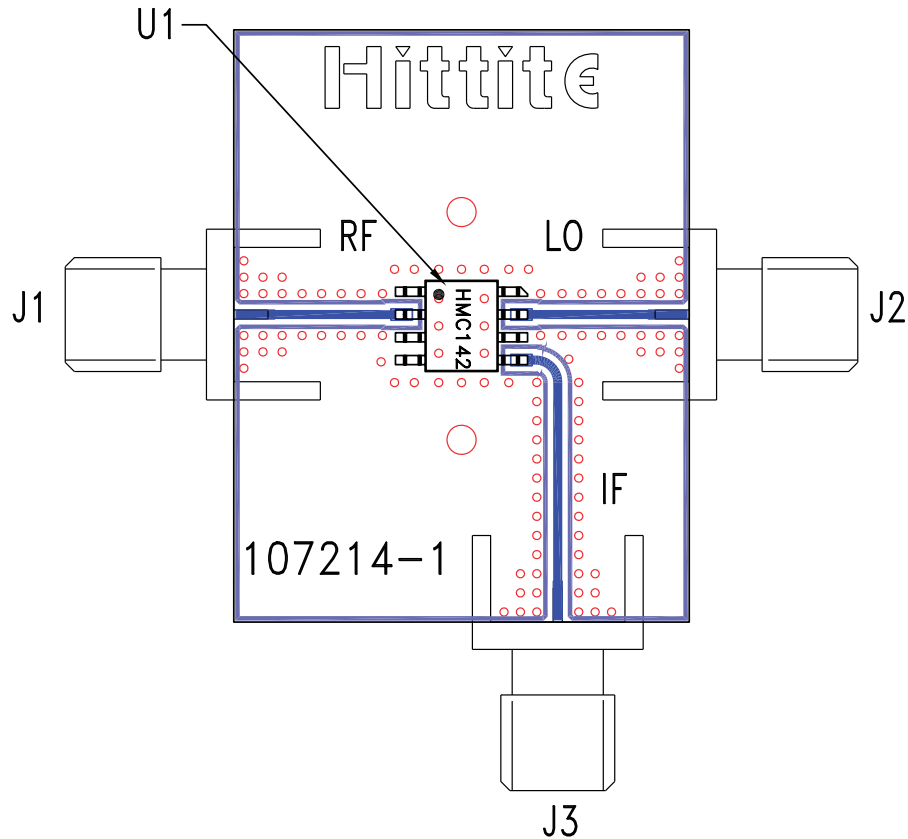
### Evaluation PCB



### List of Materials for Evaluation PCB 107216 [1]

Item	Description
J1 - J3	PCB Mount SMA RF Connector
U1	HMC142C8 Mixer
PCB [2]	107214 Evaluation Board

[1] Reference this number when ordering complete evaluation PCB

[2] Circuit Board Material: Rogers 4350

The circuit board used in the final application should use RF circuit design techniques. Signal lines should have 50 ohm impedance while the package ground leads and exposed paddle should be connected directly to the ground plane similar to that shown. A sufficient number of via holes should be used to connect the top and bottom ground planes. The evaluation circuit board shown is available from Hittite upon request.