

APPROVED: _____
 DATE: _____ TITLE: _____

Rev	AWO #	Description	Date	Appr
-		RELEASED	9/8/20	

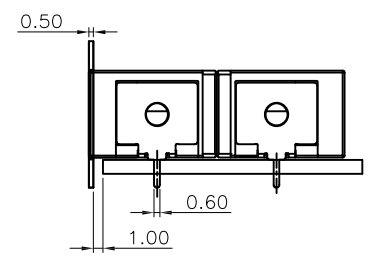
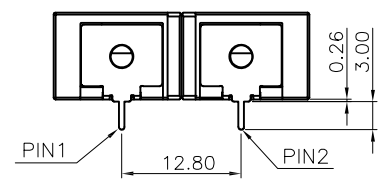
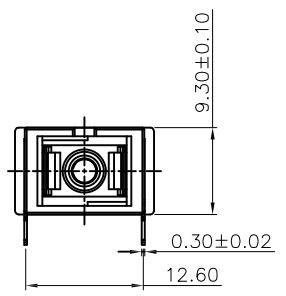
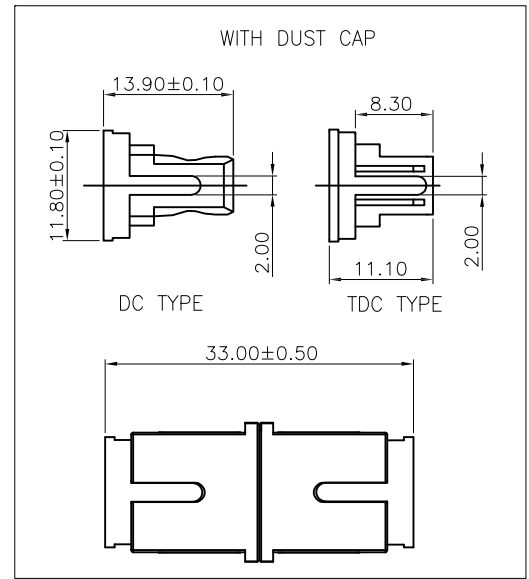
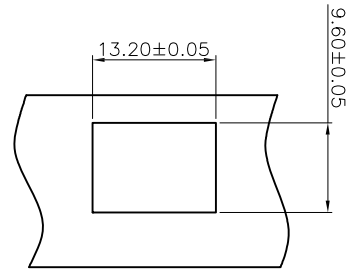
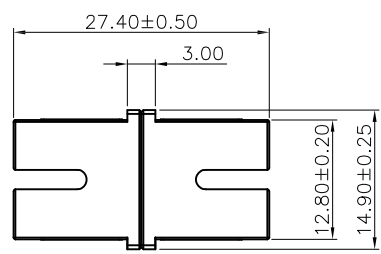
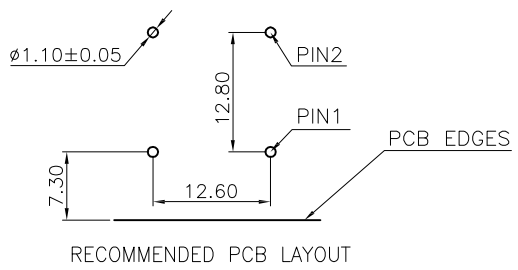

OPSB1BNSC1N2	SC/PC, CUCURBIT TYPE DUST CAP	2184C Blue	PBT Black
OPSA1BNSC1N1	SC/APC, TWO TYPE DUST CAP	7737C Green	PBT Black
PART NUMBER	DESCRIPTION	Housing&Insert color	Cap Color

SPECIFICATIONS:
 Material:
 Housing: PBT, rated UL 94V-0, Color: See Chart
 Cap: PBT, rated UL 94V-0, Color: Black
 Sleeve: Zirconia Ceramic
 Solder Foot: Copper Alloy, Nickel Plated
 Electrical:
 Standards of IEC, EIA/TIA, Telcordia
 Low Insertion loss: 0.2dB max
 Environmental:
 Lead free, RoHS compliant.



UNLESS OTHERWISE SPECIFIED
 ALL DIMENSIONS ARE MILLIMETERS
 TOLERANCES: EXCEPT AS NOTED
 MM ANGLE
 X. ± 0.35 X.* ± 2°
 .X ± 0.30 .X* ± 1°
 .XX ± 0.25 .XX* ± 0.5°
 .XXX ± 0.15 .XXX* ± 0.5°

ADAM TECH INTERCONNECTS 909 Rahway Avenue,
 Union, NJ 07083
 Phone: 908-687-5000
 Fax: 908-687-5710

APPROVALS		DATE
DRAWN	LH	9/8/20
CHECKED	JL	9/8/20
APPROVED		

TITLE SC TYPE ADAPTER, APC&PC, 1 PORTS, SHORT EARS, WITH SC CUCURBIT TYPE DUST CAP & SC TWO TYPE DUST CAP		
SIZE X	PART NO. OPSX1BNSC1NX	REV. -
REF: S00005C	SCALE: NTS	SHEET 1 OF 1