

42 V Input Power Management IC with Window Voltage Detector for Automotive Applications

No.EC-500-220310

OVERVIEW

The R5116x is a Power Management IC designed for automotive applications, featuring input voltage range from 3.5 V to 42 V. The IC contains combined 500 mA Voltage Regulator and Window Voltage Detector in a single chip

KEY BENEFITS

- Reducing components and improving functional safety
- High accuracy of the output voltage and the detector threshold: -1.25 % to 0.75 %
- Preventing the false detection of transient characteristic fluctuations by high-speed response Voltage Regulator

KEY SPECIFICATIONS

- Input Voltage Range (Max. Rating):
3.5 V to 42.0 V (50.0 V)
- Supply Current: Typ. 25 μ A

Voltage Regulator (VR)

- Output Voltage Range: 3.3 V to 5.0 V
- Output Voltage Accuracy: -1.25 % to 0.75 %
($-40^{\circ}\text{C} \leq T_a \leq 125^{\circ}\text{C}$)
- Output Current: 500 mA
- Protection:
Thermal shutdown (Detection Temp. Typ.175 $^{\circ}\text{C}$)
Output current (Typ.750 mA)
Output short-circuit (Typ.105 mA)

Voltage Detector (VD)

- Overvoltage (OV) Detector Threshold :
3.3 V to 5.5 V (in 0.01V step)
- Undervoltage (UV) Detector Threshold :
2.5 V to 5.0 V (in 0.01V step)
- Detector Threshold Accuracy:
-1.25% to 0.75% ($-40^{\circ}\text{C} \leq T_a \leq 125^{\circ}\text{C}$)
- Release hysteresis: max 0.7%

PACKAGES

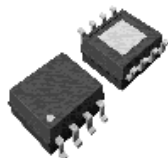

HSOP-8E
5.20 x 6.20 x 1.45 (mm)

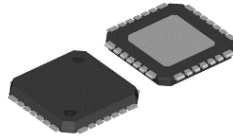

HQFN0808-28
8.8 x 8.8 x 0.95 (mm)

TYPICAL APPLICATIONS

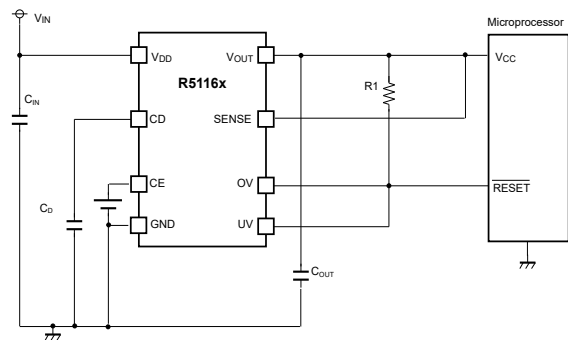

- C_{IN} : 1.0 μ F, C_{OUT} : 10 μ F, Ceramic capacitors
- C_D : Ceramic capacitors for setting detection delay time

SELECTION GUIDE

Product Name	Package	Quantity per Reel
R5116SxxxA-E2-#E	HSOP-8E	1,000 pcs
R5116LxxxA-TR-#E	HQFN0808-28	2,000pcs

xxx: Specify the set output voltage for VR (V_{VRSET}), the set OV detector threshold (V_{OVSET}) and the set UV detector threshold (V_{UVSET}) by using serial numbers starting from 001

Refer to ELECTRICAL CHARACTERISTICS for detail information.

APPLICATIONS

- Power supply system with microprocessor devices for In-Vehicle electrical equipment
- Power supply system for electronic control units such as EV inverter and battery charge control unit

SELECTION GUIDE

The set output voltages and the quality class are user-selectable options.

Product Name	Package	Quantity per Reel	Pb Free	Halogen Free
R5116SxxxA-E2-#E	HSOP-8E	1,000 pcs	Yes	Yes
R5116LxxxA-TR-#E	HQFN0808-28	2,000 pcs	Yes	Yes

xxx: Specify the set output voltage for VR (V_{VRSET}), the set OV detector threshold (V_{OVSET}) and the UV detector threshold (V_{UVSET}) by using serial numbers starting from 001⁽¹⁾
Refer to ELECTRICAL CHARACTERISTICS for detail information

#: Select the quality class

	Operating Temperature Range	Test Temperature
A	-40°C to 125°C	25°C, High
K	-40°C to 125°C	Low, 25°C, High

⁽¹⁾ The combinations of V_{VRSET} , V_{OVSET} and V_{UVSET} are following conditions;

- V_{VRSET} = 3.3 V to 5.0 V
- V_{OVSET} = 3.3 V to 5.5 V
- V_{UVSET} = 2.5 V to 5.0 V

BLOCK DIAGRAM

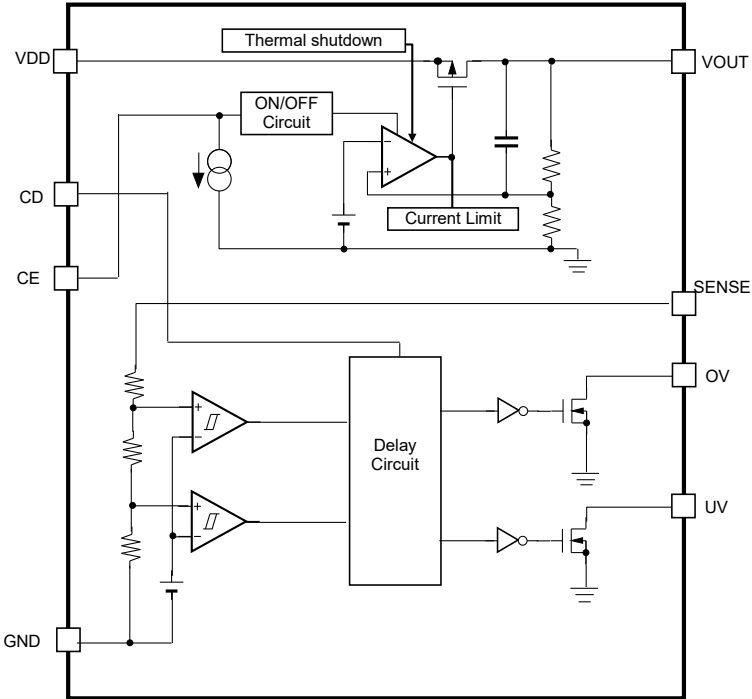

R5116xxx Block Diagram

PIN DESCRIPTIONS

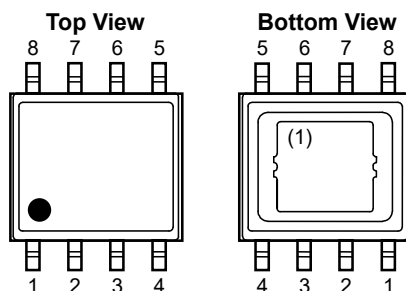

R5116S (HSOP-8E) Pin Configuration

R5116S (HSOP-8E)

Pin No.	Symbol	Description
1	VDD	Supply Voltage Pin
2	CD	Pin for setting VD Release Output Delay Time (power-on reset time)
3	CE	Chip Enable Pin (Active-high)
4	GND	Ground Pin
5	UV	UV Detection Output Pin ("Low" at detection)
6	OV	OV Detection Output Pin ("Low" at detection)
7	SENSE	SENSE Pin
8	VOUT	Regulator Output Pin

⁽¹⁾ The tab on the bottom of the package is substrate level (GND). It is recommended that the tab be connected to the ground plane on the board.

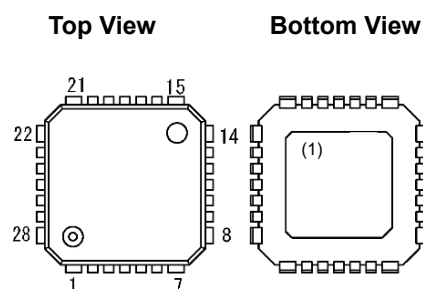

R5116L(HQFN0808-28) Pin Configuration

R5116L(HQFN0808-28)

Pin No.	Symbol	Description
1	Tab (GND)	Tab ※Internally shorted to the GND
2	NC	No Connection
3	VDD	Power Supply Pin ※Internally shorted to the 4Pin
4	VDD	Power Supply Pin ※Internally shorted to the 3Pin
5	NC	No Connection
6	CD	Voltage Detector Reset Delay Time (Power-on Reset Time) Setting Pin
7	Tab (GND)	Tab ※Internally shorted to the GND
8	Tab (GND)	Tab ※Internally shorted to the GND
9	CE	Chip Enable Pin, Active-high
10	NC	No Connection
11	GND	Ground Pin ※Internally shorted to the 12Pin
12	GND	Ground Pin ※Internally shorted to the 11Pin
13	NC	No Connection
14	Tab (GND)	Tab ※Internally shorted to the GND
15	Tab (GND)	Tab ※Internally shorted to the GND
16	UV	UV Detection Output Pin ("Low" at detection)
17	OV	OV Detection Output Pin ("Low" at detection)
18	NC	No Connection
19	SENSE	SENSE Pin
20	VOUT	Voltage Regulator Output Pin
21	Tab (GND)	Tab ※Internally shorted to the GND
22	Tab (GND)	Tab ※Internally shorted to the GND
23	NC	No Connection
24	NC	No Connection
25	NC	No Connection
26	NC	No Connection
27	NC	No Connection
28	Tab (GND)	Tab ※Internally shorted to the GND

⁽¹⁾The tab on the bottom of the package is substrate level (GND). It is recommended that the tab be connected to the ground plane on the board.

PIN EQUIVALENT CIRCUIT DIAGRAMS

< VOUT Pin >

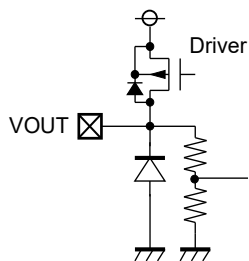

< CE Pin >

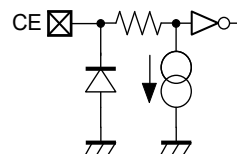

< CD Pin >

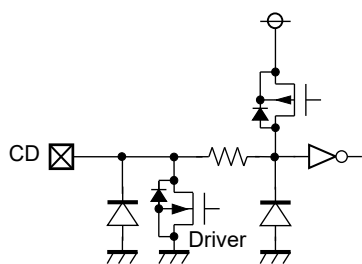

< OV Pin >

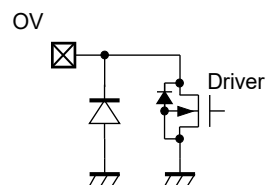

< UV Pin >

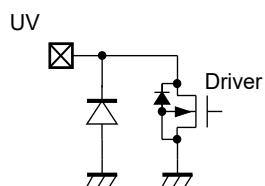

< SENSE Pin >

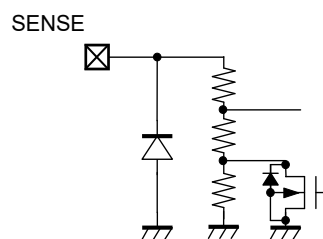

ABSOLUTE MAXIMUM RATINGS

Symbol	Parameter	Rating	Unit
V_{IN}	Input Voltage	-0.3 to 50	V
	Peak Input Voltage ⁽¹⁾	60	V
V_{CE}	CE Pin Input Voltage	-0.3 to 50	V
V_{OUT}	Output Voltage	-0.3 to $V_{IN} + 0.3 \leq 50$	V
V_{SENSE}	SENSE Pin Voltage	-0.3 to 50	V
V_{CD}	CD Pin Output Voltage	-0.3 to 50	V
V_{OVOUT}	OV Pin Output Voltage	-0.3 to 7.0	V
V_{UVOUT}	UV Pin Output Voltage	-0.3 to 7.0	V
P_D	Power Dissipation	Refer to Appendix "Power Dissipation"	
T_j	Junction Temperature	-40 to 150	°C
T_{stg}	Storage Temperature	-55 to 150	°C

ABSOLUTE MAXIMUM RATINGS

Electronic and mechanical stress momentarily exceeded absolute maximum ratings may cause permanent damage and may degrade the lifetime and safety for both device and system using the device in the field. The functional operation at or over these absolute maximum ratings are not assured.

RECOMMENDED OPERATING CONDITIONS

Symbol	Parameter	Rating	Unit
V_{IN}	Input Voltage	3.5 to 42	V
V_{CE}	CE Pin Input Voltage	0 to 42	V
V_{SENSE}	SENSE Pin Input Voltage	0 to 6.0	V
V_{OVOUT}	OV Pin Output Voltage	0 to 6.0	V
V_{UVOUT}	UV Pin Output Voltage	0 to 6.0	V
T_a	Operating Temperature	-40 to 125	°C

RECOMMENDED OPERATING CONDITIONS

All of electronic equipment should be designed that the mounted semiconductor devices operate within the recommended operating conditions. The semiconductor devices cannot operate normally over the recommended operating conditions, even if they are used over such conditions by momentary electronic noise or surge. And the semiconductor devices may receive serious damage when they continue to operate over the recommended operating conditions.

⁽¹⁾Duration time: 200 ms

ELECTRICAL CHARACTERISTICS

$C_{IN} = 1.0 \mu\text{F}$, $C_{OUT} = 10 \mu\text{F}$, $V_{IN} = 14 \text{ V}$, unless otherwise noted.

The specifications surrounded by are guaranteed by design engineering at $-40^\circ\text{C} \leq T_a \leq 125^\circ\text{C}$.

R5116xxxx-AE

For All

($T_a = 25^\circ\text{C}$)

Symbol	Parameter	Condition	Min.	Typ.	Max.	Unit
I_{SS}	Supply Current	$I_{OUT} = 0 \text{ mA}$		25	50	μA
$I_{STANDBY}$	Standby Current	$V_{IN} = 42 \text{ V}$, $V_{CE} = 0 \text{ V}$		1.5	5.0	μA
I_{PD}	CE Pull-down Current			0.2	0.6	μA
V_{CEH}	CE Input Voltage, high		2.0		42	V
V_{CEL}	CE Input Voltage, low		0		1.0	V

All test items listed under Electrical Characteristics are done under the pulse load condition ($T_j \approx T_a = 25^\circ\text{C}$).

VR Section

($T_a = 25^\circ\text{C}$)

Symbol	Parameter	Condition	Min.	Typ.	Max.	Unit	
V_{OUT}	Output Voltage	$V_{IN} = 14 \text{ V}$, $I_{OUT} = 1 \text{ mA}$	$T_a = 25^\circ\text{C}$	$\times 0.995$		$\times 1.005$	V
			$-40^\circ\text{C} \leq T_a \leq 125^\circ\text{C}$	$\times 0.9875$		$\times 1.0075$	
$\frac{\Delta V_{OUT}}{\Delta I_{OUT}}$	Load Regulation	$V_{IN} = V_{SET} + 3.0 \text{ V}$	$1 \text{ mA} \leq I_{OUT} \leq 300 \text{ mA}$	-10	0	10	mV
			$1 \text{ mA} \leq I_{OUT} \leq 500 \text{ mA}$	-15		15	
V_{DIF}	Dropout Voltage	$I_{OUT} = 500 \text{ mA}$	$V_{SET} = 3.3 \text{ V}$		1.1	1.7	V
			$V_{SET} = 5.0 \text{ V}$		0.9	1.5	
$\frac{\Delta V_{OUT}}{\Delta V_{IN}}$	Line Regulation	$I_{OUT} = 1 \text{ mA}$	$8.0 \text{ V} \leq V_{IN} \leq 16 \text{ V}$	-10	0	10	mV
			$6.0 \text{ V} \leq V_{IN} \leq 32 \text{ V}$	-25		25	
I_{LIM}	Output Current Limit	$V_{IN} = 8.0 \text{ V}$	500	750		mA	
I_{SC}	Short Current Limit	$V_{OUT} = 0 \text{ V}$	70	105	150	mA	
T_{TSD}	Thermal Shutdown Temperature	Junction Temperature	165	175		$^\circ\text{C}$	
T_{TSR}	Thermal Shutdown Release Temperature	Junction Temperature	125	145		$^\circ\text{C}$	

All test items listed under Electrical Characteristics are done under the pulse load condition ($T_j \approx T_a = 25^\circ\text{C}$).

ELECTRICAL CHARACTERISTICS

$C_{IN} = 1.0 \mu\text{F}$, $C_{OUT} = 10 \mu\text{F}$, $V_{IN} = 14 \text{V}$, unless otherwise noted.

The specifications surrounded by are guaranteed by design engineering at $-40^\circ\text{C} \leq T_a \leq 125^\circ\text{C}$.

VD Section

($T_a = 25^\circ\text{C}$)

Symbol	Parameter	Condition	Min.	Typ.	Max.	Unit
V_{OVDET}	OV Detector Threshold	$T_a = 25^\circ\text{C}$	$\times 0.995$		$\times 1.005$	V
		$-40^\circ\text{C} \leq T_a \leq 125^\circ\text{C}$	$\times 0.9875$		$\times 1.0075$	
V_{UVDET}	UV Detector Threshold	$T_a = 25^\circ\text{C}$	$\times 0.995$		$\times 1.005$	V
		$-40^\circ\text{C} \leq T_a \leq 125^\circ\text{C}$	$\times 0.9875$		$\times 1.0075$	
V_{OVHYS}	OV Detector Threshold Hysteresis		$\frac{V_{OVDET}}{\times 0.003}$	$V_{OVDET} \times 0.005$	$\frac{V_{OVDET}}{\times 0.007}$	V
V_{UVHYS}	UV Detector Threshold Hysteresis		$\frac{V_{UVDET}}{\times 0.003}$	$V_{UVDET} \times 0.005$	$\frac{V_{UVDET}}{\times 0.007}$	V
t_{DELAY}	Release Output Delay Time (Power-on Reset)	$C_D = 10 \text{ nF}$	2	4	8	ms
V_{UVLO}	UVLO Detector Threshold			1.8	2.8	V
$V_{UVLOHYS}$	UVLO Detector Threshold Hysteresis			0.1	0.2	V
V_{OVOUT}	OV Pull-up Current				6.0	V
V_{UVOUT}	UV Pull-up Current				6.0	V
I_{OUTOV}	Nch Output Current (OV Output Pin)	$V_{IN} = 3.0 \text{ V}$, $V_{DS} = 0.1 \text{ V}$	0.8	2.0		mA
I_{OUTUV}	Nch Output Current (UV Output Pin)	$V_{IN} = 3.0 \text{ V}$, $V_{DS} = 0.1 \text{ V}$	0.8	2.0		mA
I_{LEAKOV}	Nch Leakage Current (OV Output Pin)	$V_{OVOUT} = 5.5 \text{ V}$			0.3	μA
I_{LEAKUV}	Nch Leakage Current (UV Output Pin)	$V_{UVOUT} = 5.5 \text{ V}$			0.3	μA
R_{LCD}	C_D Pin Discharge Nch Tr.ON Resistance	$V_{CE} = 0 \text{ V}$, $V_{CD} = 0.1 \text{ V}$		1.2	3.0	k Ω

All test items listed under Electrical Characteristics are done under the pulse load condition ($T_j \approx T_a = 25^\circ\text{C}$).

ELECTRICAL CHARACTERISTICS

$C_{IN} = 1.0 \mu\text{F}$, $C_{OUT} = 10 \mu\text{F}$, $V_{IN} = 14 \text{ V}$, unless otherwise noted.

R5116xxxx-KE

For All

($-40^{\circ}\text{C} \leq T_a \leq 125^{\circ}\text{C}$)

Symbol	Parameter	Condition	Min.	Typ.	Max.	Unit
I_{SS}	Supply Current	$I_{OUT} = 0 \text{ mA}$		25	50	μA
$I_{STANDBY}$	Standby Current	$V_{IN} = 42 \text{ V}$, $V_{CE} = 0 \text{ V}$		1.5	5.0	μA
I_{PD}	CE Pull-down Current			0.2	0.6	μA
V_{CEH}	CE Input Voltage,high		2.0		42	V
V_{CEL}	CE Input Voltage,low		0		1.0	V

VR Section

($-40^{\circ}\text{C} \leq T_a \leq 125^{\circ}\text{C}$)

Symbol	Parameter	Condition	Min.	Typ.	Max.	Unit	
V_{OUT}	Output Voltage	$V_{IN} = 14 \text{ V}$, $I_{OUT} = 1 \text{ mA}$	$T_a = 25^{\circ}\text{C}$	$\times 0.995$		$\times 1.005$	V
			$-40^{\circ}\text{C} \leq T_a \leq 125^{\circ}\text{C}$	$\times 0.9875$		$\times 1.0075$	
$\frac{\Delta V_{OUT}}{\Delta I_{OUT}}$	Load Regulation	$V_{IN} = V_{SET} + 3.0 \text{ V}$	$1 \text{ mA} \leq I_{OUT} \leq 300 \text{ mA}$	-10	0	10	mV
			$1 \text{ mA} \leq I_{OUT} \leq 500 \text{ mA}$	-15		15	
V_{DIF}	Dropout Voltage	$I_{OUT} = 500 \text{ mA}$	$V_{SET} = 3.3 \text{ V}$		1.1	1.7	V
			$V_{SET} = 5.0 \text{ V}$		0.9	1.5	
$\frac{\Delta V_{OUT}}{\Delta V_{IN}}$	Line Regulation	$I_{OUT} = 1 \text{ mA}$	$8.0 \text{ V} \leq V_{IN} \leq 16 \text{ V}$	-10	0	10	mV
			$6.0 \text{ V} \leq V_{IN} \leq 32 \text{ V}$	-25		25	
I_{LIM}	Output Current Limit	$V_{IN} = 8.0 \text{ V}$	500	750		mA	
I_{SC}	Short Current Limit	$V_{OUT} = 0 \text{ V}$	70	105	150	mA	
T_{TSD}	Thermal Shutdown Temperature	Junction Temperature	165	175		$^{\circ}\text{C}$	
T_{TSR}	Thermal Shutdown Release Temperature	Junction Temperature	125	145		$^{\circ}\text{C}$	

ELECTRICAL CHARACTERISTICS

$C_{IN} = 1.0 \mu\text{F}$, $C_{OUT} = 10 \mu\text{F}$, $V_{IN} = 14 \text{V}$, unless otherwise noted.

VD Section

($-40^\circ\text{C} \leq T_a \leq 125^\circ\text{C}$)

Symbol	Parameter	Condition	Min.	Typ.	Max.	Unit
V_{OVDET}	OV Detector Threshold	$T_a = 25^\circ\text{C}$	$\times 0.995$		$\times 1.005$	V
		$-40^\circ\text{C} \leq T_a \leq 125^\circ\text{C}$	$\times 0.9875$		$\times 1.0075$	
V_{UVDET}	UV Detector Threshold	$T_a = 25^\circ\text{C}$	$\times 0.995$		$\times 1.005$	V
		$-40^\circ\text{C} \leq T_a \leq 125^\circ\text{C}$	$\times 0.9875$		$\times 1.0075$	
V_{OVHYS}	OV Detector Threshold Hysteresis		$V_{OVDET} \times 0.003$	$V_{OVDET} \times 0.005$	$V_{OVDET} \times 0.007$	V
V_{UVHYS}	UV Detector Threshold Hysteresis		$V_{UVDET} \times 0.003$	$V_{UVDET} \times 0.005$	$V_{UVDET} \times 0.007$	V
t_{DELAY}	Release Output Delay Time (Power-on Reset)	$C_D = 10 \text{ nF}$	2	4	8	ms
V_{UVLO}	UVLO Detector Threshold			1.8	2.8	V
$V_{UVLOHYS}$	UVLO Detector Threshold Hysteresis			0.1	0.2	V
V_{OVOUT}	OV Pull-up Voltage				6.0	V
V_{UVOUT}	UV Pull-up Voltage				6.0	V
I_{OUTOV}	Nch Output Current (OV Output Pin)	$V_{IN} = 3.0 \text{ V}$, $V_{DS} = 0.1 \text{ V}$	0.8	2.0		mA
I_{OUTUV}	Nch Output Current (UV Output Pin)	$V_{IN} = 3.0 \text{ V}$, $V_{DS} = 0.1 \text{ V}$	0.8	2.0		mA
I_{LEAKOV}	Nch Leakage Current (OV Output Pin)	$V_{OVOUT} = 5.5 \text{ V}$			0.3	μA
I_{LEAKUV}	Nch Leakage Current (UV Output Pin)	$V_{UVOUT} = 5.5 \text{ V}$			0.3	μA
R_{LCD}	CD Pin Discharge Nch Tr.ON Resistance	$V_{CE} = 0 \text{ V}$, $V_{CD} = 0.1 \text{ V}$		1.2	3.0	k Ω

R5116x (-AE) Product-specific Electrical Characteristics

The specifications surrounded by are guaranteed by design engineering at $-40^{\circ}\text{C} \leq T_a \leq 125^{\circ}\text{C}$

Product Name	V _{OUT}			V _{OUT}		
	Ta=25°C			-40°C ≤ Ta ≤ 125°C		
	Min.	Typ.	Max.	Min.	Typ.	Max.
R5116x001A	4.975	5.000	5.025	4.938	5.000	5.037
R5116x002A	3.284	3.300	3.316	3.259	3.300	3.324
R5116x003A	4.975	5.000	5.025	4.938	5.000	5.037

Product Name	V _{OVDET}			V _{OVDET}			V _{OVHYS}		
	Ta=25°C			-40°C ≤ Ta ≤ 125°C			Ta=25°C		
	Min.	Typ.	Max.	Min.	Typ.	Max.	Min.	Typ.	Max.
R5116x001A	5.274	5.300	5.326	5.234	5.300	5.339	0.01590	0.02650	0.03710
R5116x002A	3.523	3.540	3.557	3.496	3.540	3.566	0.01062	0.01770	0.02478
R5116x003A	5.234	5.260	5.286	5.195	5.260	5.299	0.01578	0.02630	0.03682

Product Name	V _{UVDET}			V _{UVDET}			V _{UVHYS}		
	Ta=25°C			-40°C ≤ Ta ≤ 125°C			Ta=25°C		
	Min.	Typ.	Max.	Min.	Typ.	Max.	Min.	Typ.	Max.
R5116x001A	4.677	4.700	4.723	4.642	4.700	4.735	0.01410	0.02350	0.03290
R5116x002A	3.035	3.050	3.065	3.012	3.050	3.072	0.00915	0.01525	0.02135
R5116x003A	2.488	2.500	2.512	2.469	2.500	2.518	0.00750	0.01250	0.01750

R5116x (-KE) Product-specific Electrical Characteristics

Product Name	V _{OUT}			V _{OUT}		
	Ta=25°C			-40°C ≤ Ta ≤ 125°C		
	Min.	Typ.	Max.	Min.	Typ.	Max.
R5116x001A	4.975	5.000	5.025	4.938	5.000	5.037
R5116x002A	3.284	3.300	3.316	3.259	3.300	3.324
R5116x003A	4.975	5.000	5.025	4.938	5.000	5.037

Product Name	V _{OVDET}			V _{OVDET}			V _{OVHYS}		
	Ta=25°C			-40°C ≤ Ta ≤ 125°C			Ta=25°C		
	Min.	Typ.	Max.	Min.	Typ.	Max.	Min.	Typ.	Max.
R5116x001A	5.274	5.300	5.326	5.234	5.300	5.339	0.01590	0.02650	0.03710
R5116x002A	3.523	3.540	3.557	3.496	3.540	3.566	0.01062	0.01770	0.02478
R5116x003A	5.234	5.260	5.286	5.195	5.260	5.299	0.01578	0.02630	0.03682

Product Name	V _{UVDET}			V _{UVDET}			V _{UVHYS}		
	Ta=25°C			-40°C ≤ Ta ≤ 125°C			Ta=25°C		
	Min.	Typ.	Max.	Min.	Typ.	Max.	Min.	Typ.	Max.
R5116x001A	4.677	4.700	4.723	4.642	4.700	4.735	0.01410	0.02350	0.03290
R5116x002A	3.035	3.050	3.065	3.012	3.050	3.072	0.00915	0.01525	0.02135
R5116x003A	2.488	2.500	2.512	2.469	2.500	2.518	0.00750	0.01250	0.01750

THEORY OF OPERATION

Thermal Shutdown

When the junction temperature of this device exceeds 175°C (Typ.), the built-in thermal shutdown circuit stops the regulator operation. After that, when the temperature drops to 145°C (Typ.) or lower, the regulator restarts the operation. Unless eliminating the overheating problem, the regulator turns on and off repeatedly and a pulse shaped output voltage occurs as result.

R5116xxx Voltage Detector

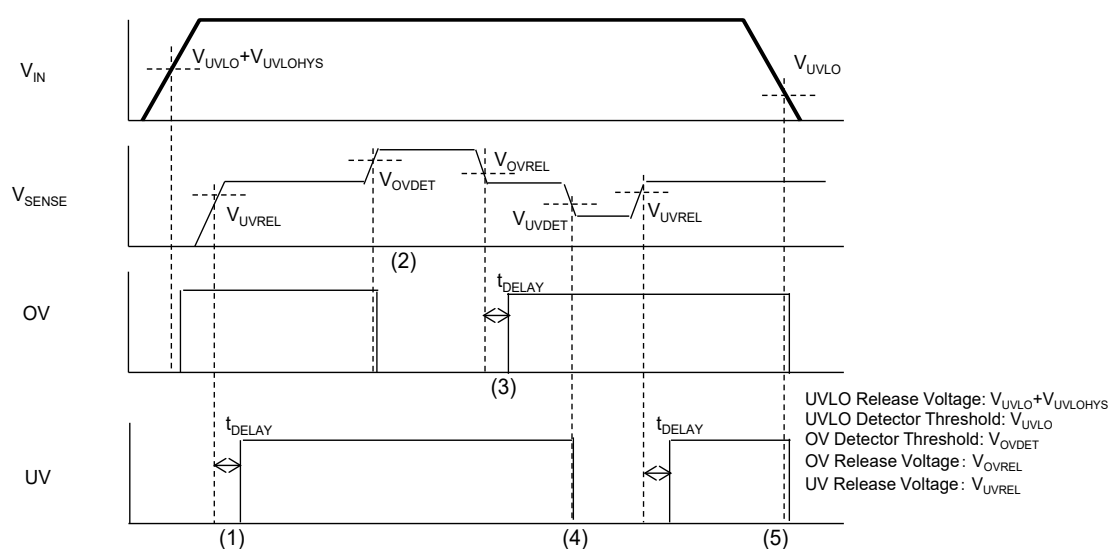

R5116xxx Voltage Detector Timing Chart

- (1) When the SENSE pin voltage (V_{SENSE}) exceed the UV release voltage (V_{UVREL}), the UV pin output becomes "High" after the release delay time (t_{DELAY}).
- (2) When V_{SENSE} exceed the OV detector threshold (V_{OVDET}) by increasing in voltage, the OV pin output becomes "Low" after the detection delay time (Typ.100 μ s) and enters the OV detecting state.
- (3) When V_{SENSE} decreases less than the OV release voltage (V_{OVREL}), the OV pin output becomes "High" after the release delay time (t_{DELAY}).
- (4) When V_{SENSE} decreases less than the UV detector threshold (V_{UVDET}), the UV pin output becomes "Low" after the detection delay time (Typ.100 μ s) and enters the UV detecting state.
- (5) When the input pin voltage (V_{IN}) decreases less than the UVLO detector threshold (V_{UVLO}), the OV and UV pins output become "Low".

VD Delay Operation and Release Delay Time (t_{DELAY})

At Undervoltage Detection

When supplying a voltage higher than the UV release voltage (V_{UVREL}) to the SENSE pin, a charging to an external capacitor starts and the CD pin voltage (V_{CD}) increases. The UV pin voltage (V_{UV}) maintains “Low” until V_{CD} reaches the CD pin threshold voltage (V_{TCD}). When V_{CD} exceeds V_{TCD} , V_{UV} is inverted from “Low” to “High”. The release delay time (t_{DELAY}) is the period from the time the SENSE pin voltage (V_{SENSE}) exceeds V_{UVREL} to a rising edge of V_{UV} . When the output voltage turns from “Low” to “High”, a charge carrier of the external capacitor starts discharging. When supplying a voltage lower than the UV detector threshold (V_{UVDET}) to the SENSE pin, the detection delay time (t_{PHL}) remains constant independently of the external capacitor. t_{PHL} is the time V_{UV} is inverted from “High” to “Low”.

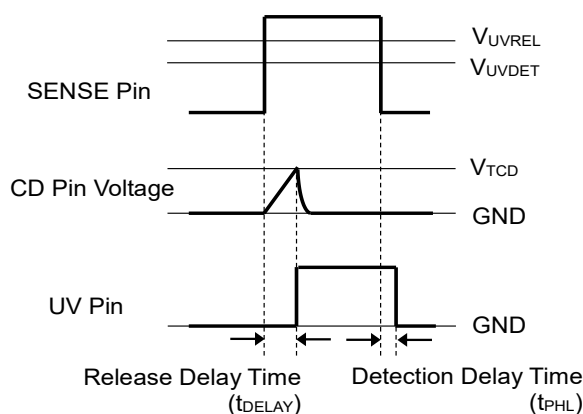

Undervoltage Release Delay Timing Diagram

Calculation of Undervoltage Release Delay Time

The following equation can calculate a typical value of the release delay time (t_{DELAY}) with using the external capacitor (C_{D}).

$$t_{\text{DELAY}} (\text{s}) = 0.72 \times C_{\text{D}} (\text{F}) / (1.8 \times 10^{-6})$$

t_{DELAY} is the period from supplying a pulse voltage of 1.0 V to ($V_{\text{UVDET}} + 1.0 \text{ V}$) to the SENSE pin to the UV pin reached 2.5 V after the UV pin is pulled up to 5V by connecting with a resistor of 100k Ω .

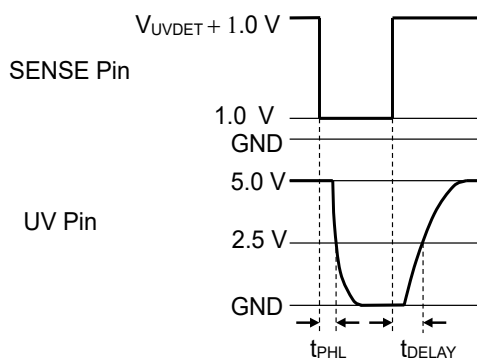

At Overvoltage Detection

When supplying a voltage lower than the OV release voltage (V_{OVREL}) to the SENSE pin, a charging to an external capacitor starts and the CD pin voltage (V_{CD}) increases. The OV pin voltage (V_{OV}) maintains “Low” until V_{CD} reaches the CD pin threshold voltage (V_{TCD}). When V_{CD} exceeds V_{TCD} , V_{OV} is inverted from “Low” to “High”. The release delay time (t_{DELAY}) is the period from the time the SENSE pin voltage (V_{SENSE}) falls below V_{OVREL} to a rising edge of V_{OV} . When the output voltage turns from “Low” to “High”, a charge carrier of the external capacitor starts discharging. When the voltage higher than OV detector threshold (V_{OVDED}) is supplied to the SENSE pin, the detection delay time (t_{PHL}) remains constant independently of the external capacitor. t_{PHL} is the period that V_{OV} is inverted from “High” to “Low”.

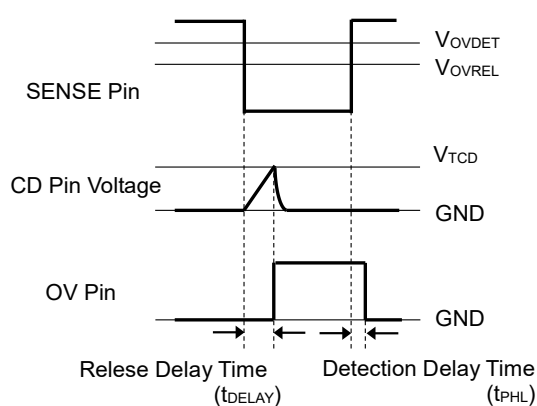

Overvoltage Release Delay Timing Diagram

Calculation of Overvoltage Release Delay Time

The following equation can calculate a typical value of the release delay time (t_{DELAY}) with using the external capacitor (C_D).

$$t_{DELAY} (s) = 0.72 \times C_D (F) / (1.8 \times 10^{-6})$$

t_{DELAY} is the period from supplying a pulse voltage of 6.0 V to (V_{OVREL}) - 1.0 V to the SENSE pin to the OV pin reached 2.5 V after the OV pin is pulled up to 5V by connecting with a resistor of 100k Ω .

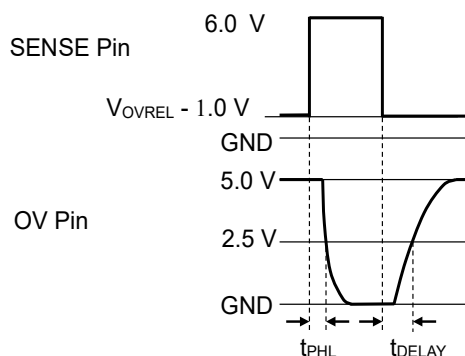

Voltage Setting of Voltage Regulator

The Window Voltage Detector (Window VD) detects the drop and rise of the Voltage Regulator (VR). When the UV release voltage (V_{UVREL}) is set to a voltage above the VR output voltage (V_{OUT}), the reset signal of Window VD is not released even if Window VD monitors the VR output voltage returns to the normal value after detecting the drop of VR. When the OV release voltage (V_{OVREL}) is set to a voltage under the VR output voltage (V_{OUT}), the reset signal of Window VD is not released even if Window VD monitors the VR output voltage returns to the normal value after detecting the rise of VR.

To prevent this issue, the following conditions are required between V_{OUT} and V_{UVREL} , and between V_{OUT} and V_{OVREL} .

$$(VR \text{ Set Output Voltage}) \times 0.9875 - 15 \text{ mV}^* > (UV \text{ Set Detector Threshold}) \times 1.0075 \times 1.007$$

$$(OV \text{ Set Detector Threshold}) \times 0.9875 \times 0.993 > (VR \text{ Set Output Voltage}) \times 1.0075 + 15 \text{ mV}^*$$

* 15mV is the worst value of load regulation

When using a device without the above conditions of V_{OUT} and V_{DET} , careful consideration must be given to the system operation before use.

APPLICATION INFORMATION

TYPICAL APPLICATIONS

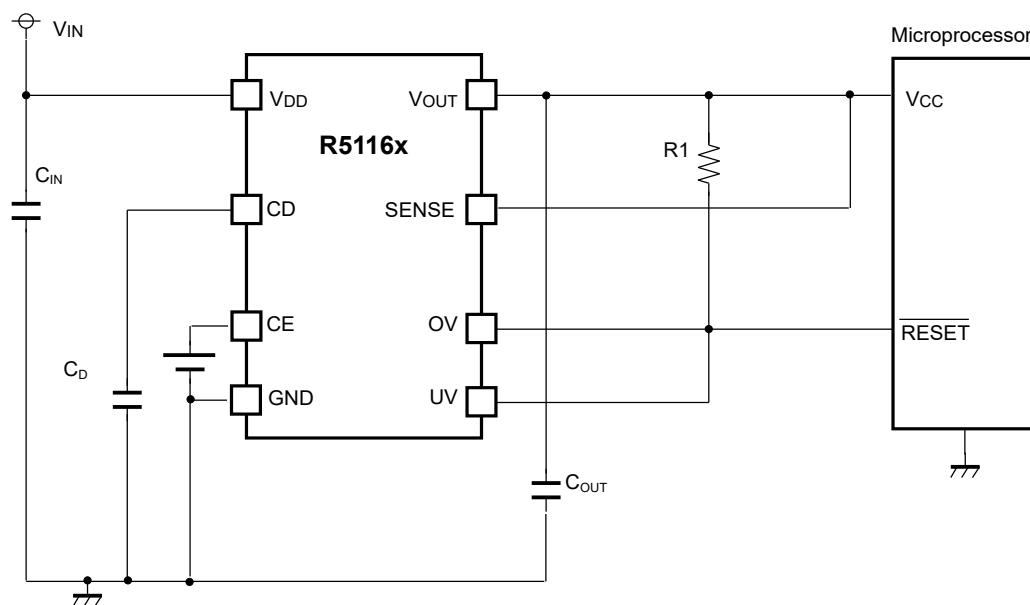

R5116xxx TYPICAL APPLICATIONS

Recommended Components

Symbol	Description
C _{IN}	Ceramic Capacitor, 1.0 μ F or more, 50V Rated Voltage, CGA4J3X7R1H105K, TDK
C _{OUT}	Ceramic Capacitor, 10 μ F or more, 50V Rated Voltage, CGA4J1X7R0J106K, TDK
C _D	A capacitor corresponding to setting of Release Output Delay Time
R1	A resistor covering the output current at Nch. driver ON and the leakage current at Nch. driver OFF. Refer to "Electrical Characteristic" providing the evaluation result with using a resistor of 100k Ω .

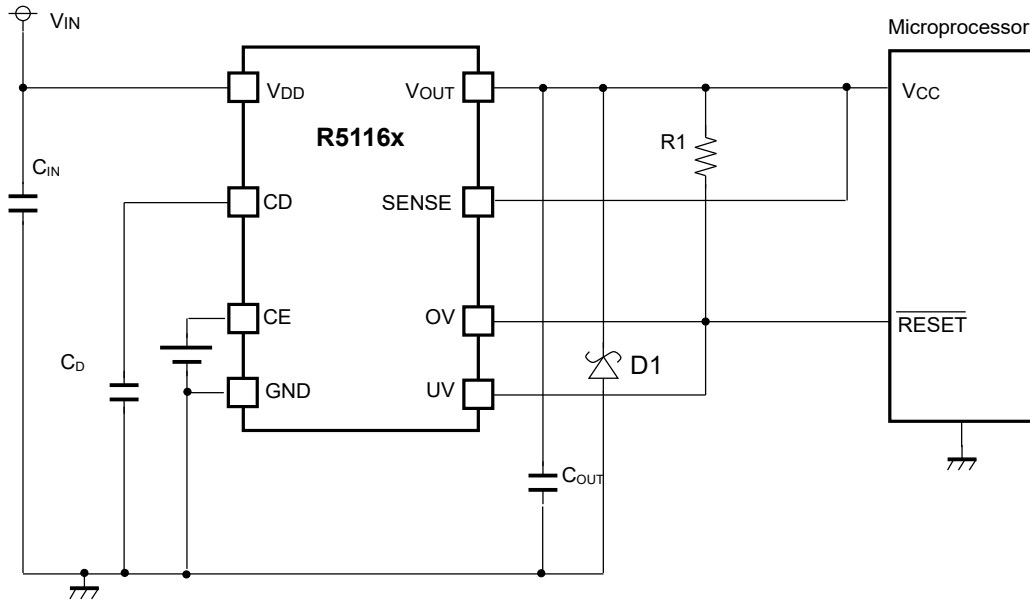
TYPICAL APPLICATION FOR IC CHIP BREAKDOWN PREVENTION**R5116xxx Typical Application for IC Chip Breakdown Prevention**

When a sudden surge of electrical current travels along the VOUT pin and GND due to a short-circuit, electrical resonance of a circuit involving an output capacitor (C_{OUT}) and a short circuit inductor generates a negative voltage and may damage the device or the load devices. Connecting a schottky diode (D1) between the VOUT pin and GND has the effect of preventing damage to them.

TECHNICAL NOTES

The performance of a power source circuit using this device is highly dependent on a peripheral circuit. A peripheral component or the device mounted on PCB should not exceed a rated voltage, a rated current or a rated power. When designing a peripheral circuit, please be fully aware of the following points.

Phase Compensation

Phase compensation is provided to secure stable operation even when the load current is varied by utilizing capacity of the output ceramic capacitor and Equivalent Series Resistance (ESR). For this purpose, be sure to use a capacitor with 10 μF or more (C_{OUT}) and wire it to the pin as short as possible.

Evaluate the circuit with consideration of temperature and frequency characteristics, in case ESR value of the capacitor is large and the output is unstable. The capacitor with 1.0 μF or more (C_{IN}) connected in between VDD pin and GND pin must be wired the shortest.

TYPICAL CHARACTERISTICS

Note: Typical Characteristics are intended to be used as reference data; they are not guaranteed.

1) Supply Current vs. Temperature ($V_{IN} = 14V$)

$V_{VRSET} = 3.3V, V_{UVSET} = 3.18V, V_{OVSET} = 3.43V$

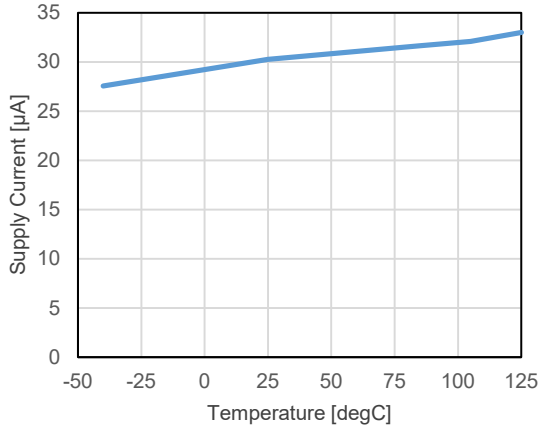

$V_{VRSET} = 5.0V, V_{UVSET} = 4.83V, V_{OVSET} = 5.17V$

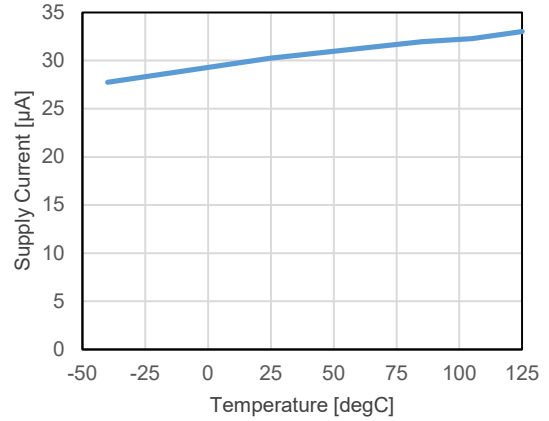

2) Supply Current vs. Input Voltage

$V_{VRSET} = 3.3V, V_{UVSET} = 3.18V, V_{OVSET} = 3.43V$

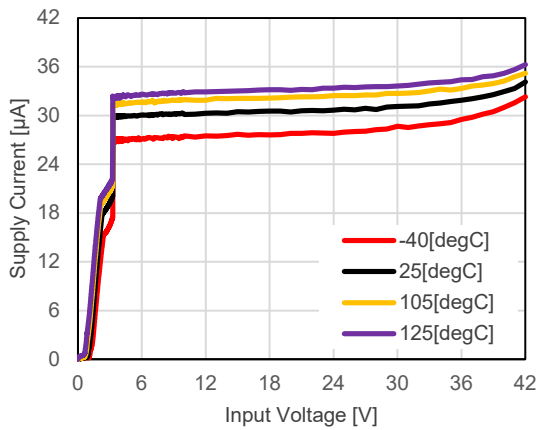

$V_{VRSET} = 5.0V, V_{UVSET} = 4.83V, V_{OVSET} = 5.17V$

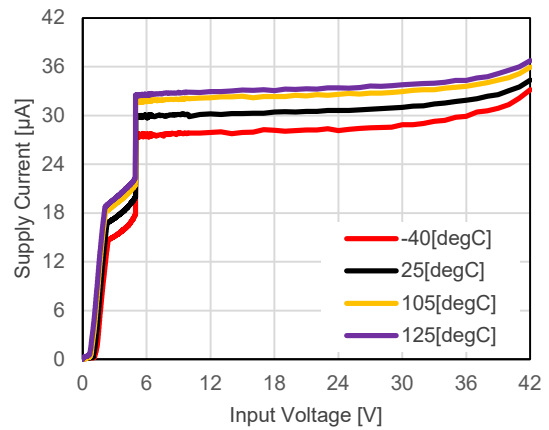

3) Supply Current vs. SENSE Voltage

$V_{VRSET} = 3.3V, V_{UVSET} = 3.18V, V_{OVSET} = 3.43V$

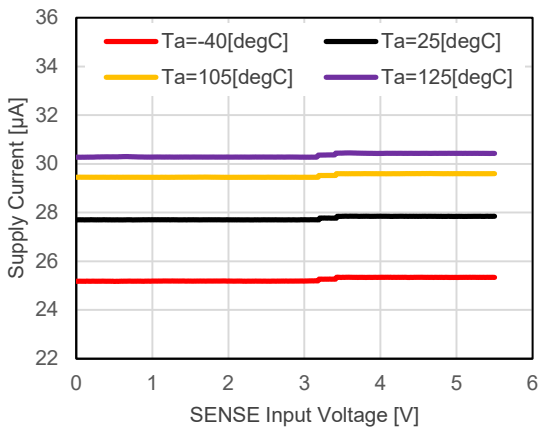

$V_{VRSET} = 5.0V, V_{UVSET} = 4.83V, V_{OVSET} = 5.17V$

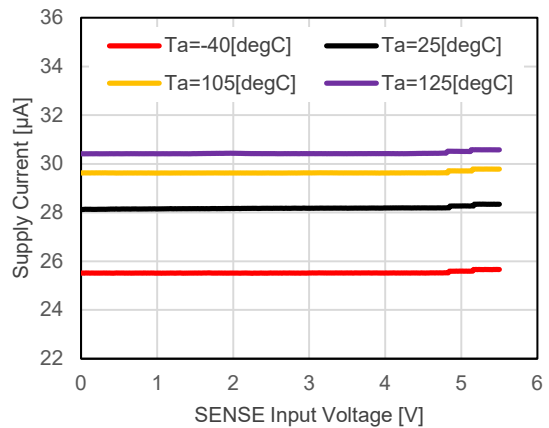

4) Output Voltage vs. Output Current ($V_{IN} = V_{VRSET} + 3.0\text{ V}$, $T_a = 25\text{ }^\circ\text{C}$)

$V_{VRSET} = 3.3\text{V}$

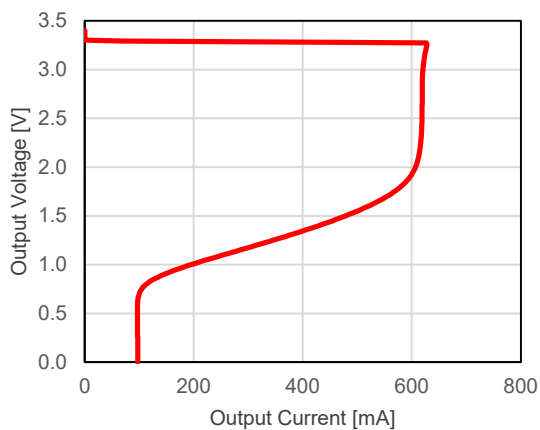

$V_{VRSET} = 5.0\text{V}$

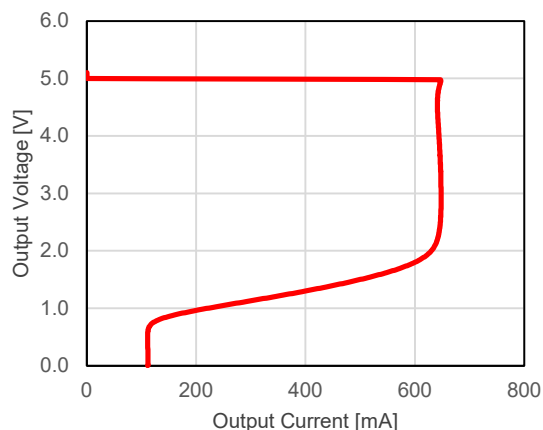

5) Output Voltage vs. Input Voltage ($T_a = 25\text{ }^\circ\text{C}$)

$V_{VRSET} = 3.3\text{V}$

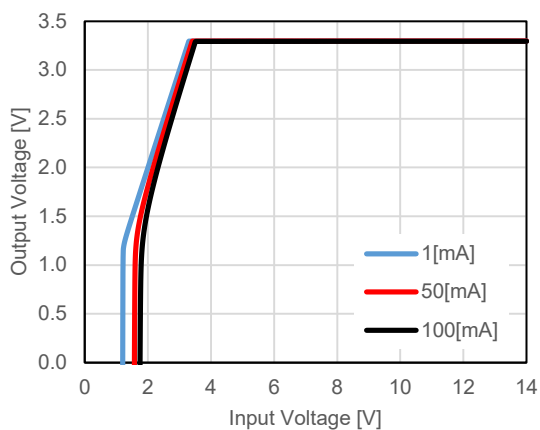

$V_{VRSET} = 5.0\text{V}$

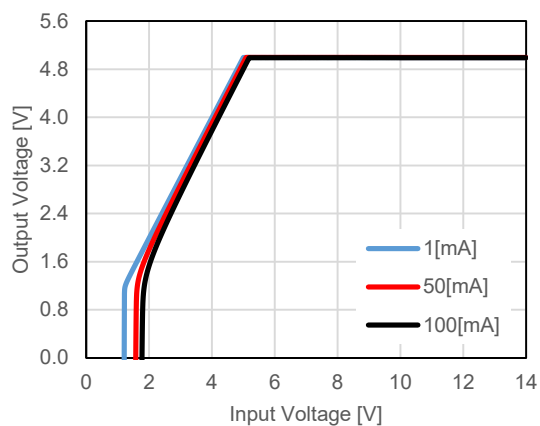

6) Output Voltage vs. Temperature ($V_{IN} = 14\text{V}$, $I_{OUT} = 1\text{ mA}$)

$V_{VRSET} = 3.3\text{V}$

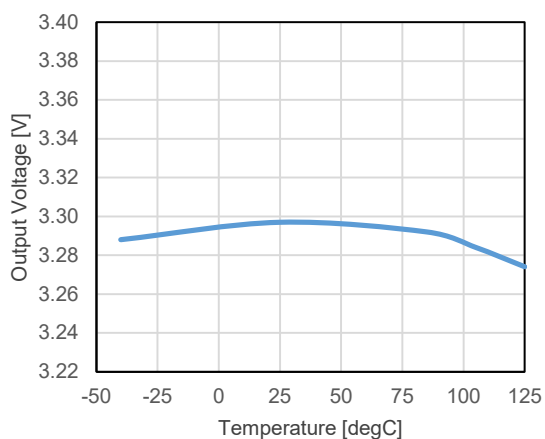

$V_{VRSET} = 5.0\text{V}$

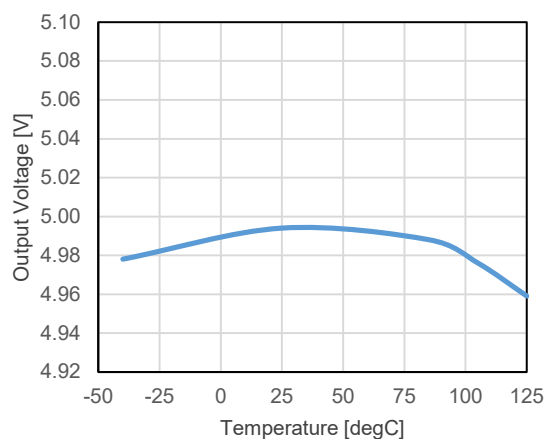

7) Dropout Voltage vs. Output Current

$V_{VRSET} = 3.3V$

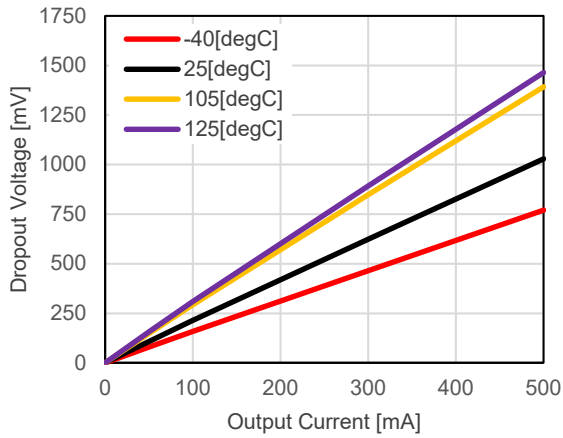

$V_{VRSET} = 5.0V$

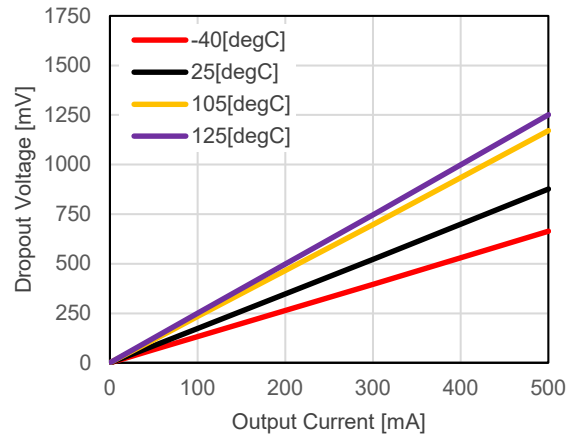

8) Ripple Rejection vs. Input Voltage ($T_a=25\text{ }^\circ\text{C}$, $V_{ripple} = \pm 0.2V$)

$V_{VRSET} = 3.3V$

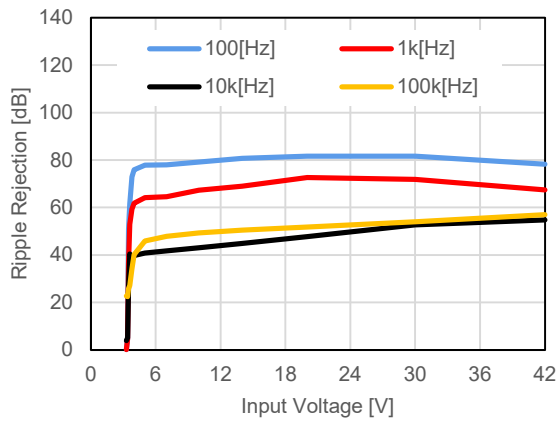

$V_{VRSET} = 5.0V$

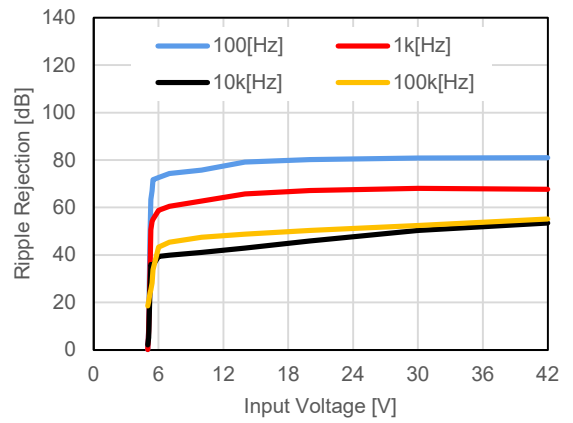

9) Ripple Rejection vs. Frequency ($T_a=25\text{ }^\circ\text{C}$, $V_{IN} = 14V \pm 0.2V_{ripple}$)

$V_{VRSET} = 3.3V$

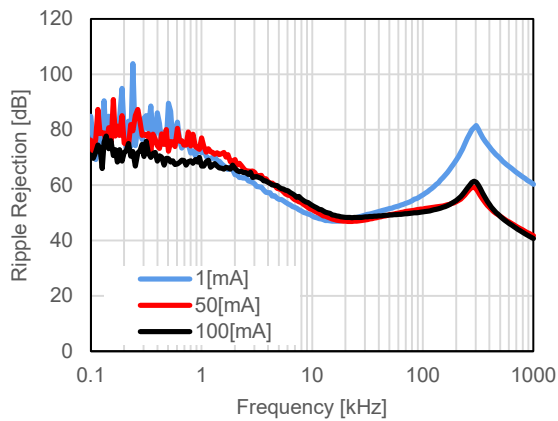

$V_{VRSET} = 5.0V$

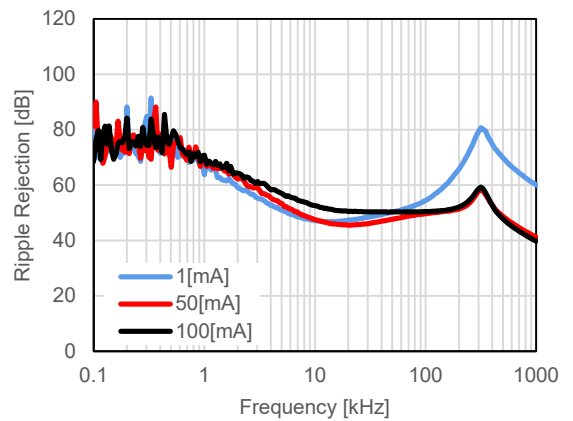

10) Input Transient Response ($T_a=25\text{ }^\circ\text{C}$, $V_{IN} = V_{VRSET} + 3.0\text{ V} \Leftrightarrow V_{VRSET} + 8.0\text{ V}$, $I_{OUT} = 1\text{ mA}$)

$V_{VRSET} = 3.3\text{V}$

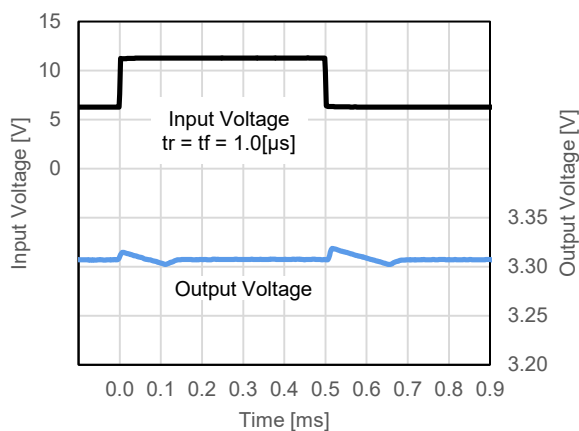

$V_{VRSET} = 5.0\text{V}$

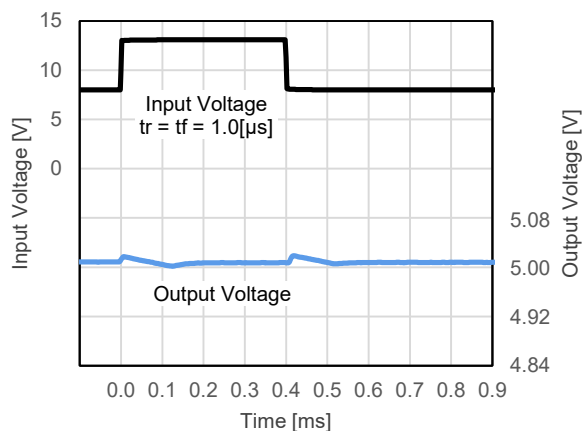

11) Load Transient Response ($T_a=25\text{ }^\circ\text{C}$, $I_{OUT} = 1\text{ }\Leftrightarrow\text{ }20\text{mA}$, $V_{IN} = 14\text{V}$)

$V_{VRSET} = 3.3\text{V}$

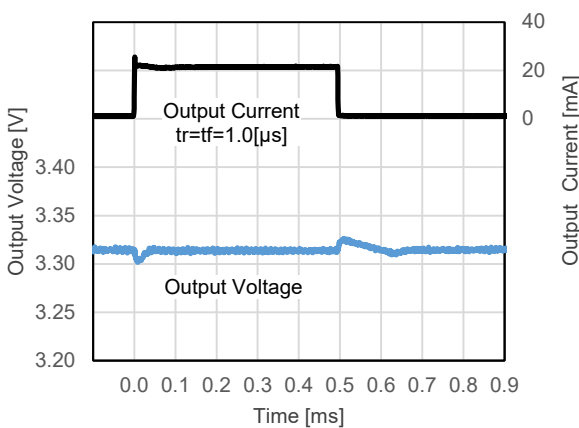

$V_{VRSET} = 5.0\text{V}$

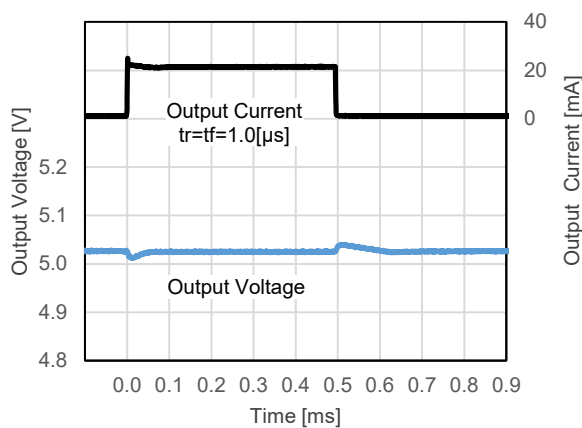

12) CE Transient Response ($T_a=25\text{ }^\circ\text{C}$, $V_{IN} = 14\text{V}$, $I_{OUT} = 1\text{ mA}$)

$V_{VRSET} = 3.3\text{V}$

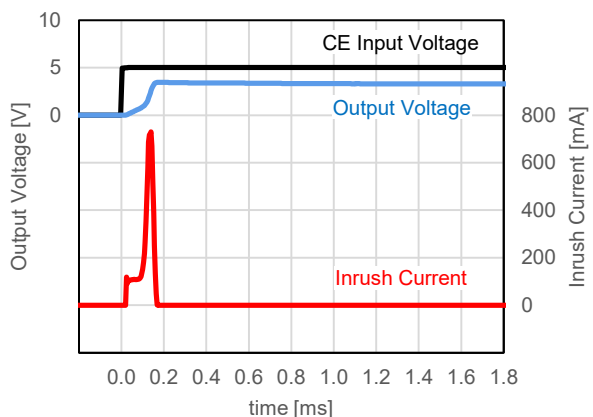

$V_{VRSET} = 3.3\text{V}$

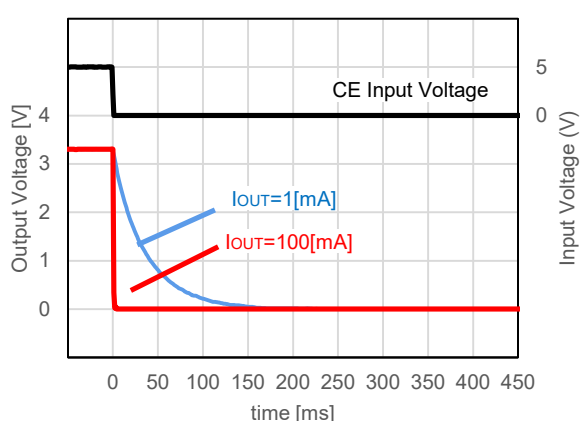

$V_{VRSET} = 5.0V$

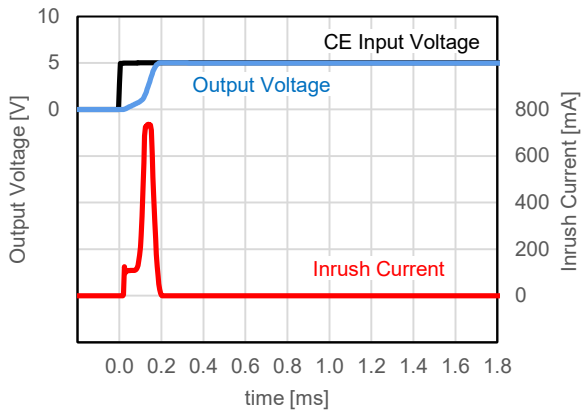

$V_{VRSET} = 5.0V$

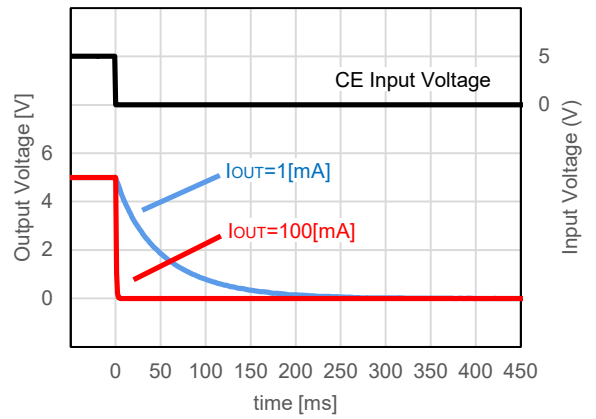

13) Load Dump ($T_a = 25^\circ C$, $I_{OUT} = 1 mA$)

$V_{VRSET} = 3.3V$

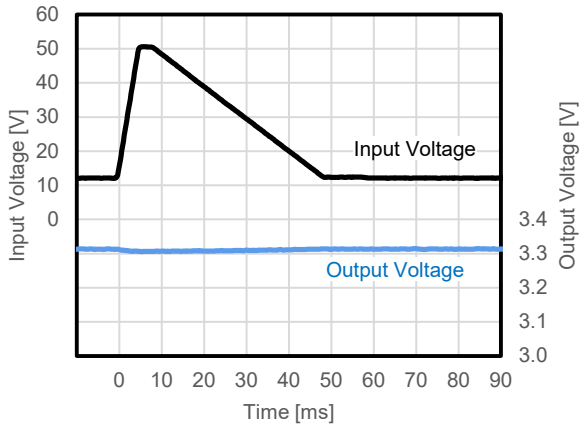

$V_{VRSET} = 5.0V$

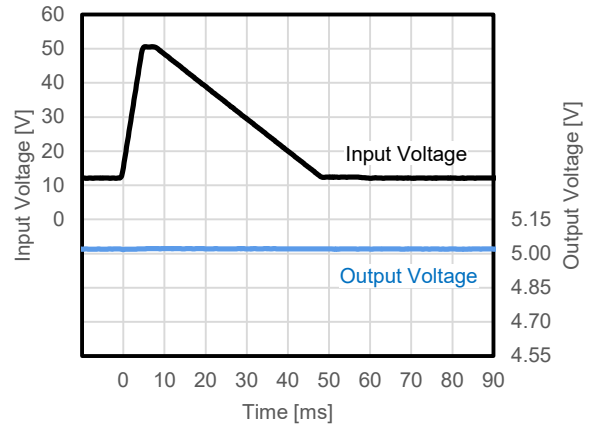

14) Cranking ($T_a = 25^\circ C$, $I_{OUT} = 1 mA$)

$V_{VRSET} = 3.3V$

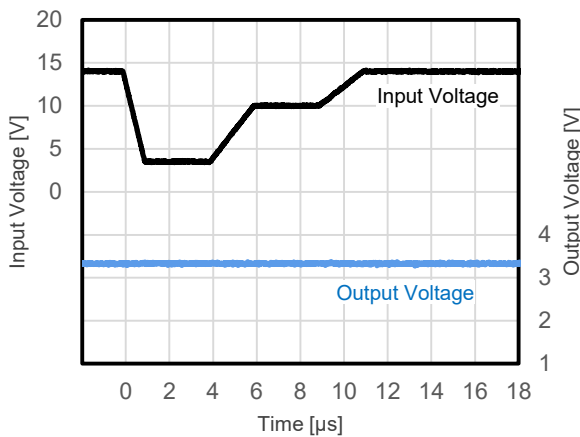

$V_{VRSET} = 5.0V$

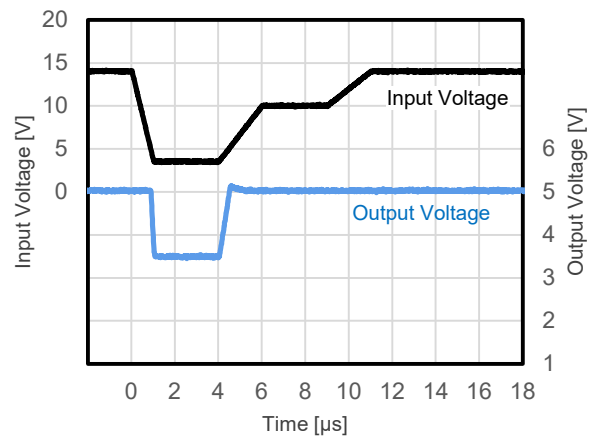

15) UV/OV Detection Voltage vs. Temperature

$V_{UVSET} = 3.18V$, $V_{OVSET} = 3.43V$

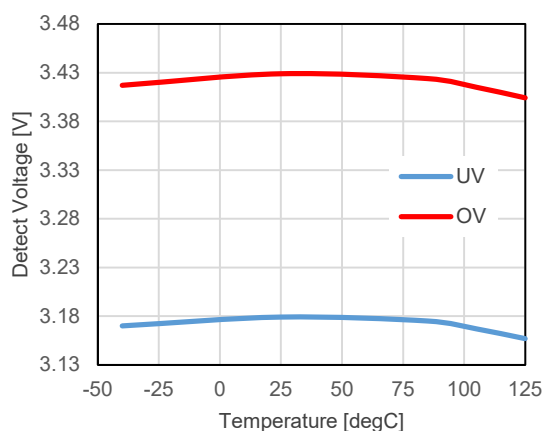

$V_{UVSET} = 4.83V$, $V_{OVSET} = 5.17V$

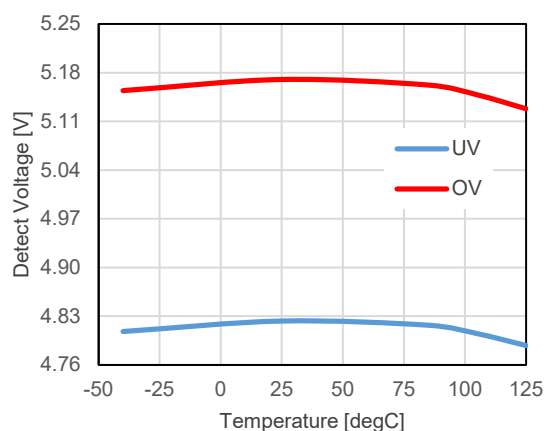

16) UV/OV Release Voltage vs. Temperature

$V_{UVSET} = 3.18V$, $V_{OVSET} = 3.43V$

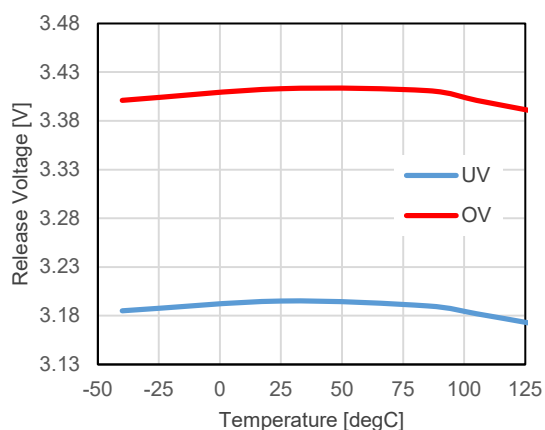

$V_{UVSET} = 4.83V$, $V_{OVSET} = 5.17V$

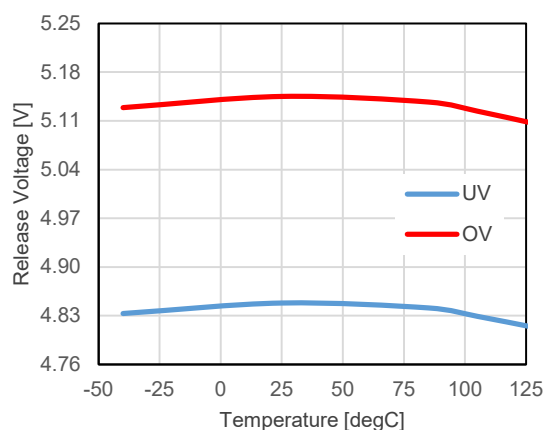

17) UV/OV Detection Voltage vs. Input Voltage

$V_{UVSET} = 3.18V$

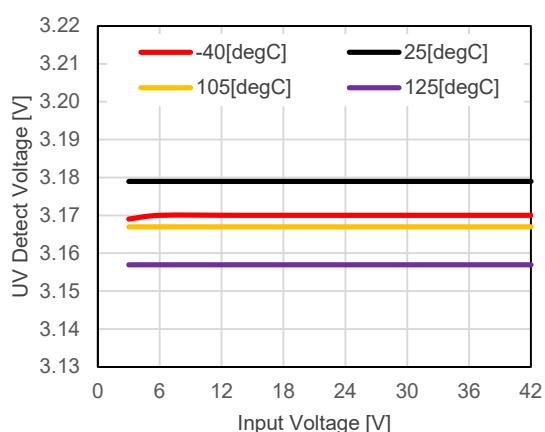

$V_{OVSET} = 3.43V$

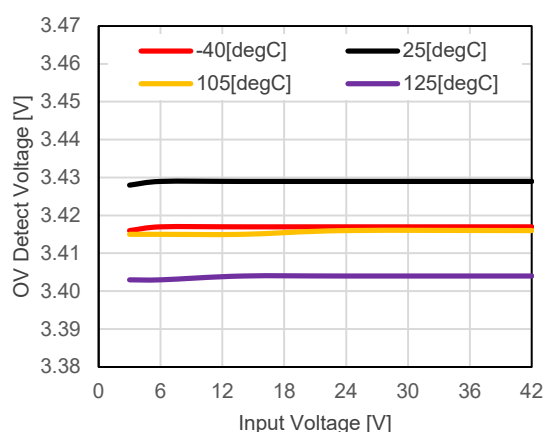

V_{UVSET} = 4.83V

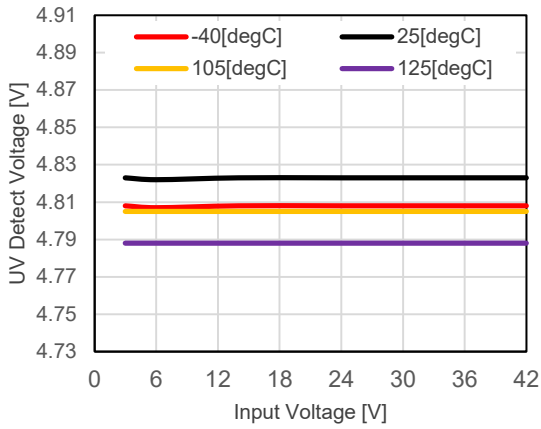

V_{OVSET} = 5.17V

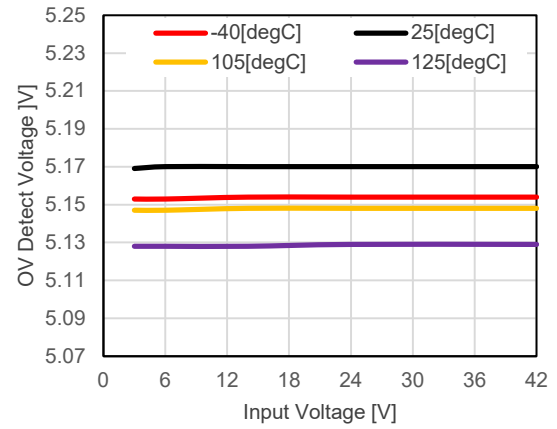

18) UV/OV Release Voltage vs. Input Voltage

V_{UVSET} = 3.18V

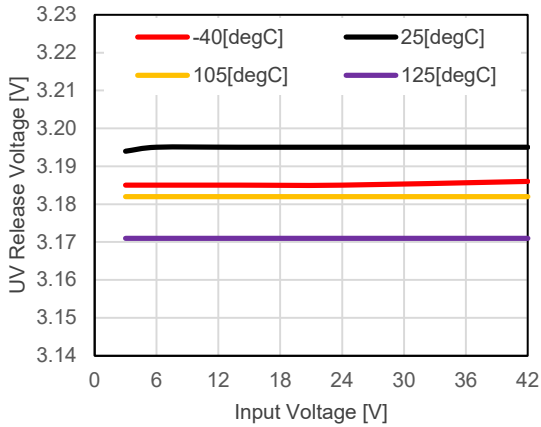

V_{OVSET} = 3.43V

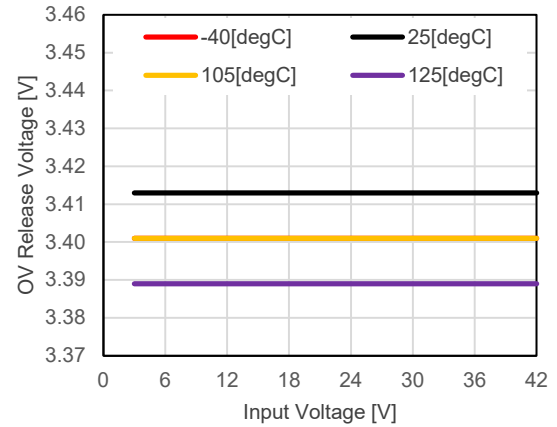

V_{UVSET} = 4.83V

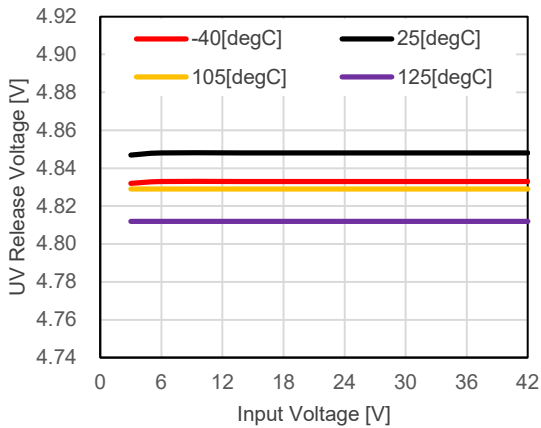

V_{OVSET} = 5.17V

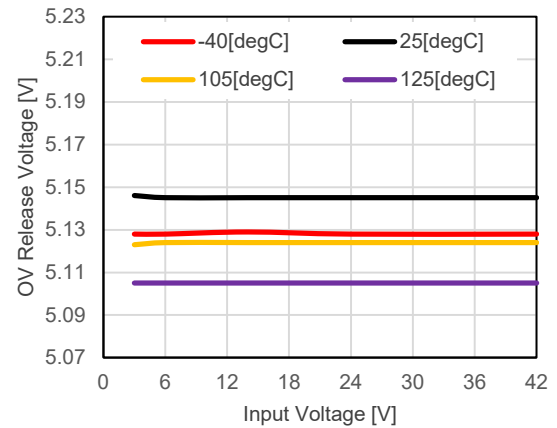

19) UV/OV Voltage vs. Input Voltage (Ta =25 °C) Pull-up Voltage 5.0 V

$V_{UVSET} = 3.18V, V_{OVSET} = 3.43V$

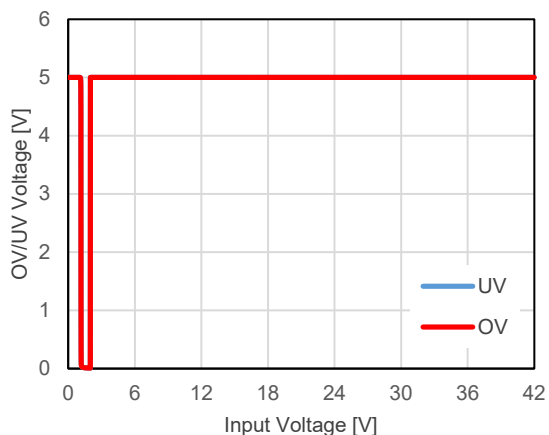

$V_{UVSET} = 4.83V, V_{OVSET} = 5.17V$

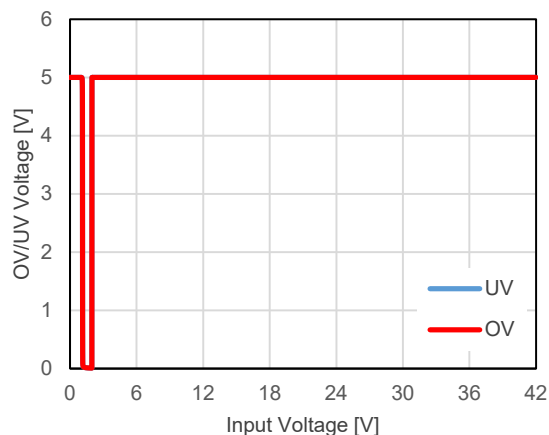

20) UV/OV Voltage vs. SENSE Voltage (Ta =25 °C) Pull-up Voltage 5.0 V

$V_{UVSET} = 3.18V, V_{OVSET} = 3.43V$

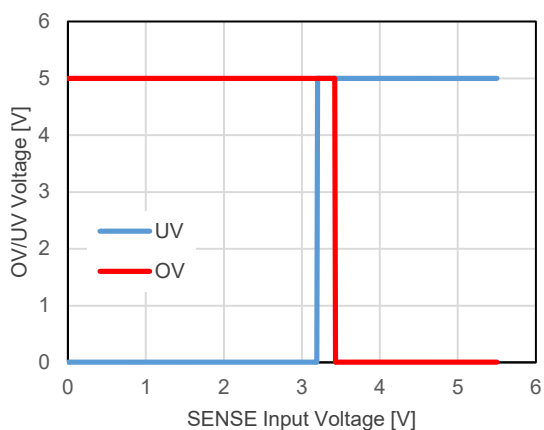

$V_{UVSET} = 4.83V, V_{OVSET} = 5.17V$

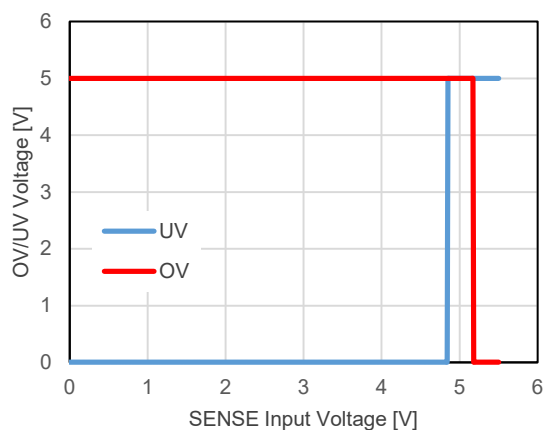

21) UV/OV Driver Output Current vs. Input Voltage

$V_{UVSET} = 4.83V$

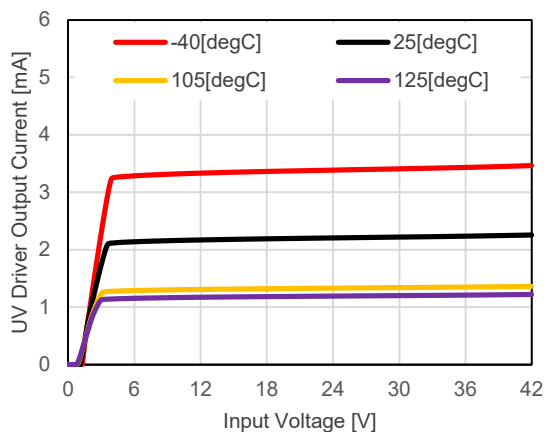

$V_{OVSET} = 5.17V$

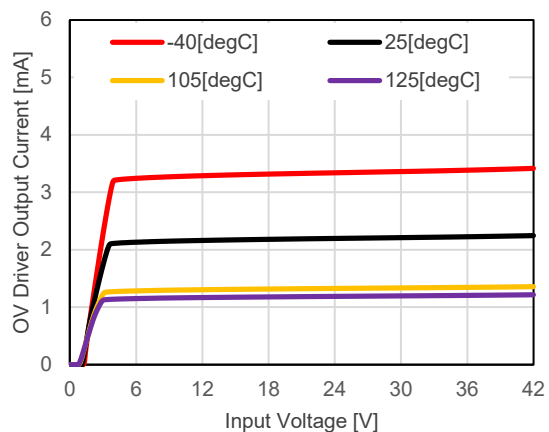

22) UV/OV Driver Output Current vs. V_{DS} ($T_a = 25\text{ }^\circ\text{C}$)

$V_{UVSET} = 4.83\text{V}$

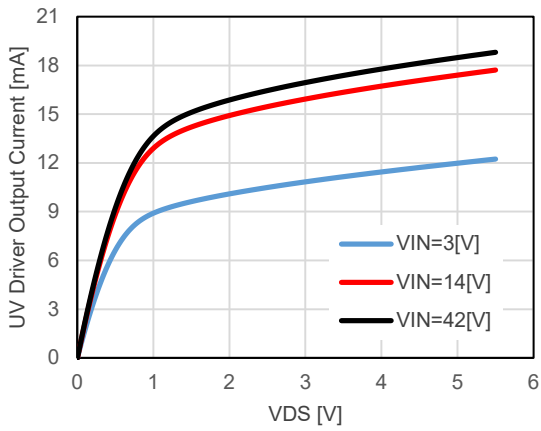

$V_{OVSET} = 5.17\text{V}$

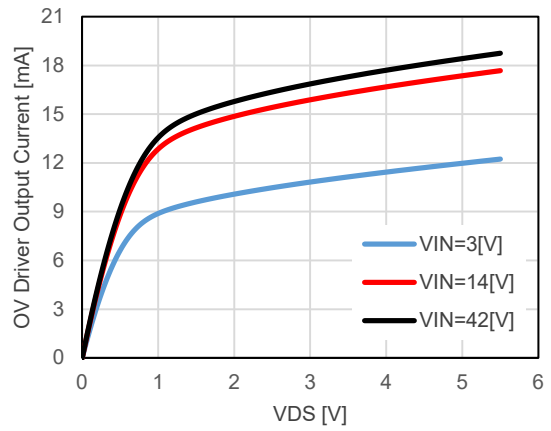

23) Release Delay Time vs. Temperature

$V_{UVSET} = 4.83\text{V}$, $V_{OVSET} = 5.17\text{V}$

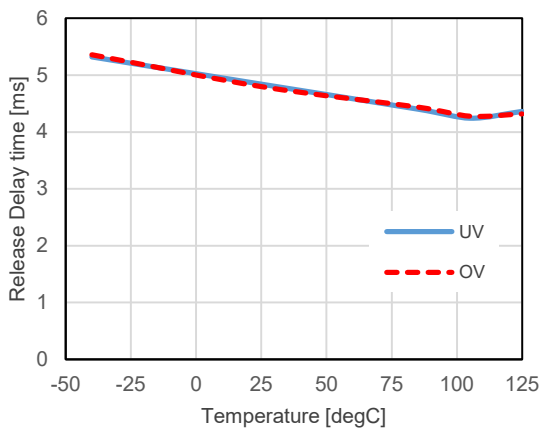

24) Detection Delay Time vs. Temperature

$V_{UVSET} = 4.83\text{V}$, $V_{OVSET} = 5.17\text{V}$

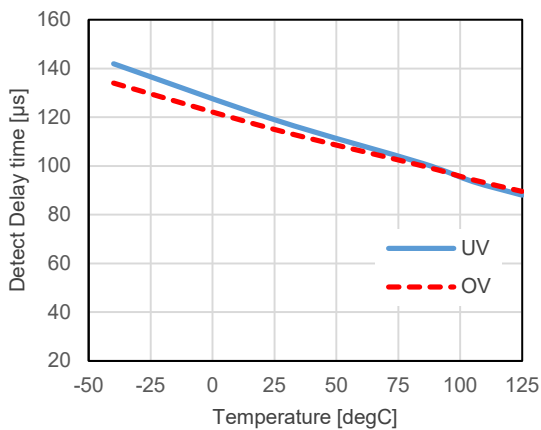

25) Release Delay Time vs. Input Voltage

$V_{UVSET} = 4.83V$

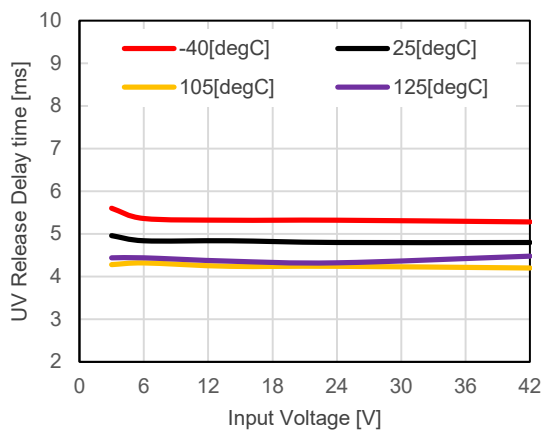

$V_{OVSET} = 5.17V$

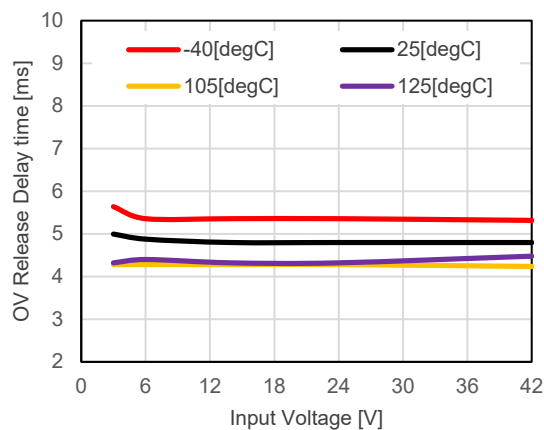

26) Detection/Release Delay Time vs. External Capacitance for CD Pin ($T_a = 25\text{ }^\circ\text{C}$)

$V_{UVSET} = 4.83V, V_{OVSET} = 5.17V$

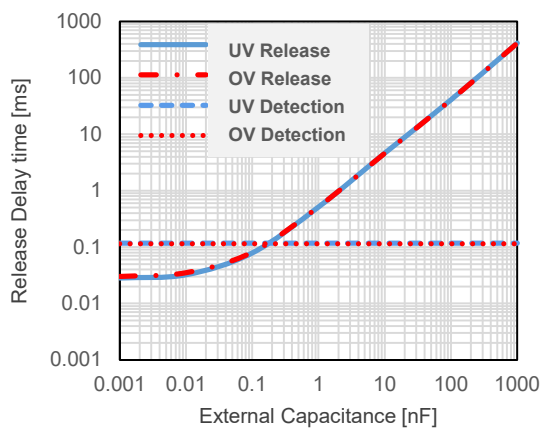

27) SENSE Pulse Width vs. SENSE Overdrive Voltage ($T_a = 25\text{ }^\circ\text{C}$)

Limit Pulse of Release State

$V_{UVSET} = 4.83V, V_{OVSET} = 5.17V$

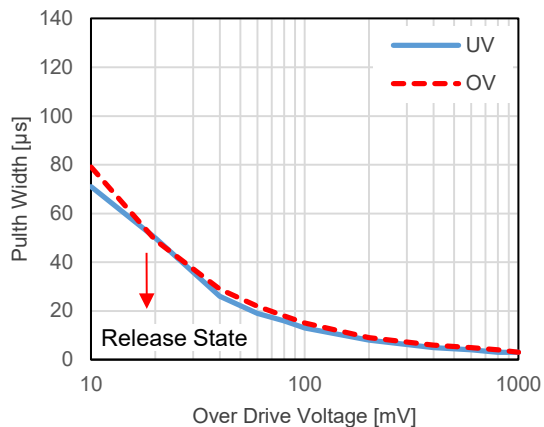

The power dissipation of the package is dependent on PCB material, layout, and environmental conditions. The following measurement conditions are based on JEDEC STD. 51-7.

Measurement Conditions

Item	Measurement Conditions
Environment	Mounting on Board (Wind Velocity = 0 m/s)
Board Material	Glass Cloth Epoxy Plastic (Four-Layer Board)
Board Dimensions	76.2 mm × 114.3 mm × 0.8 mm
Copper Ratio	Outer Layer (First Layer): Less than 95% of 50 mm Square Inner Layers (Second and Third Layers): Approx. 100% of 50 mm Square Outer Layer (Fourth Layer): Approx. 100% of 50 mm Square
Through-holes	φ 0.3 mm × 21 pcs

Measurement Result

(Ta = 25°C, Tjmax = 150°C)

Item	Measurement Result
Power Dissipation	3600 mW
Thermal Resistance (θja)	θja = 34.5°C/W
Thermal Characterization Parameter (ψjt)	ψjt = 10°C/W

θja: Junction-to-Ambient Thermal Resistance

ψjt: Junction-to-Top Thermal Characterization Parameter

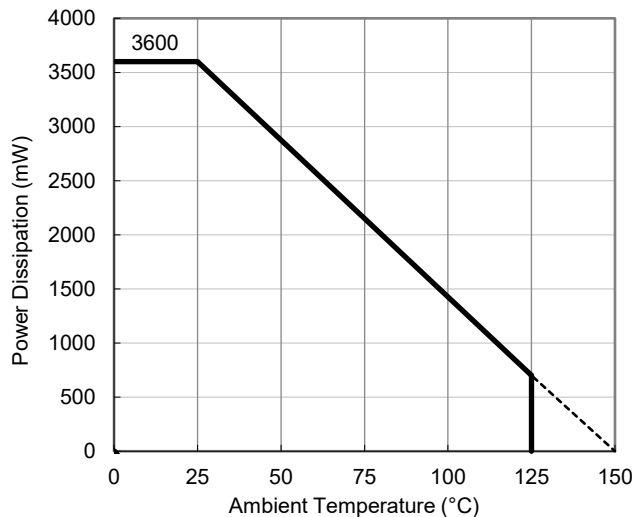

Power Dissipation vs. Ambient Temperature

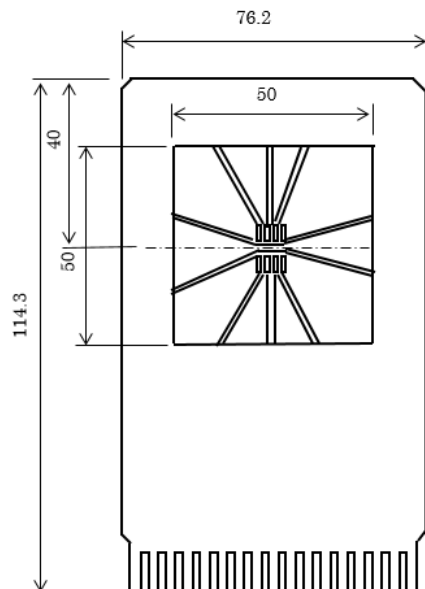

Measurement Board Pattern

PACKAGE DIMENSIONS

HSOP-8E

DM-HSOP-8E-JE-B

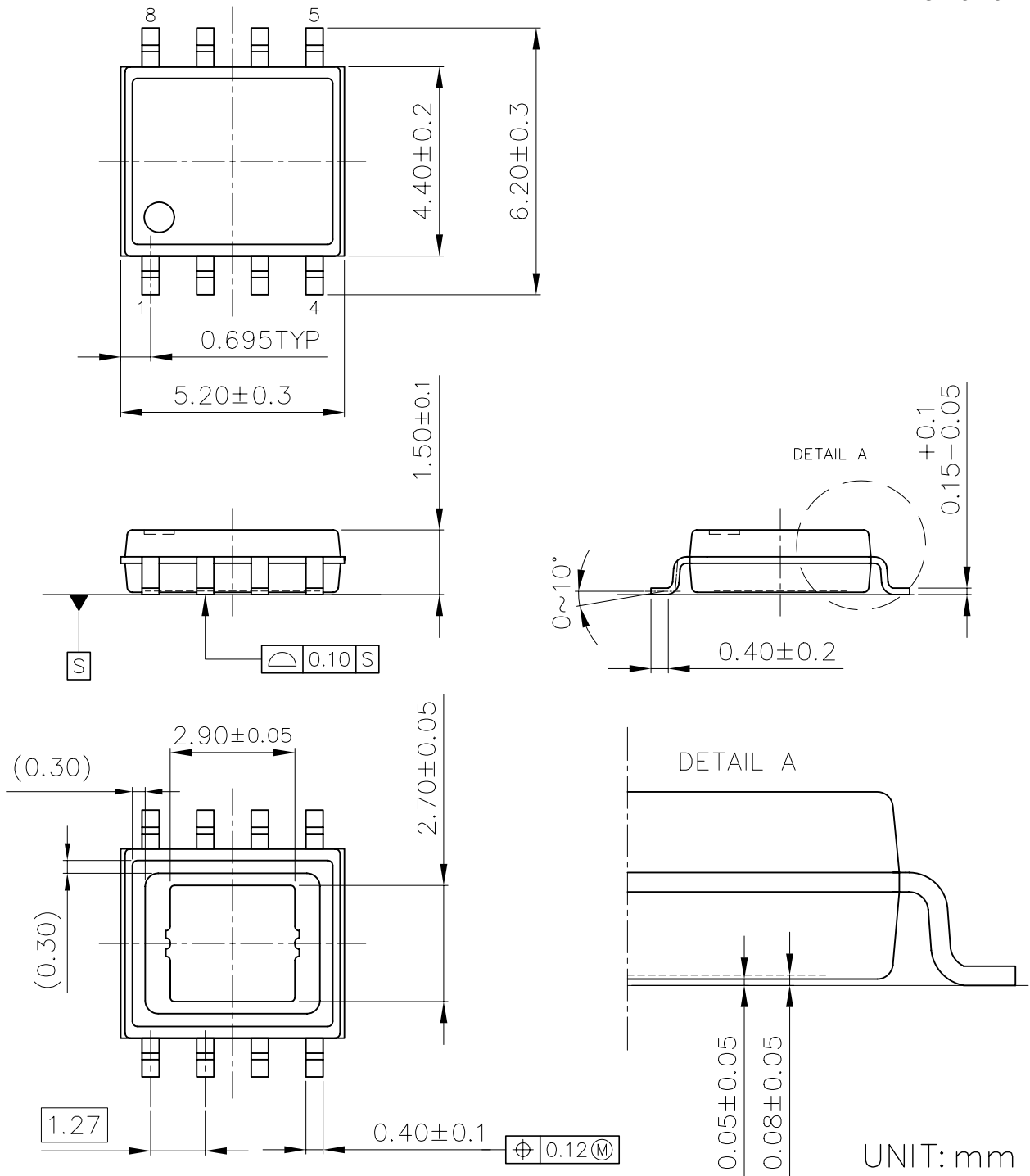

UNIT: mm

HSOP-8E Package Dimensions

The power dissipation of the package is dependent on PCB material, layout, and environmental conditions. The following measurement conditions are based on JEDEC STD. 51-7.

Measurement Conditions

Item	Measurement Conditions
Environment	Mounting on Board (Wind Velocity = 0 m/s)
Board Material	Glass Cloth Epoxy Plastic (Four-Layer Board)
Board Dimensions	76.2 mm × 114.3 mm × 0.8 mm
Copper Ratio	Outer Layer (First Layer): Less than 95% of 50 mm Square Inner Layers (Second and Third Layers): Approx. 100% of 50 mm Square Outer Layer (Fourth Layer): Approx. 100% of 50 mm Square
Through-holes	φ 0.3 mm × 72 pcs

Measurement Result

(Ta = 25°C, Tjmax = 150°C)

Item	Measurement Result
Power Dissipation	5800 mW
Thermal Resistance (θja)	θja = 21.5°C/W
Thermal Characterization Parameter (ψjt)	ψjt = 5°C/W

θja: Junction-to-ambient thermal resistance.

ψjt: Junction-to-top of package thermal characterization parameter

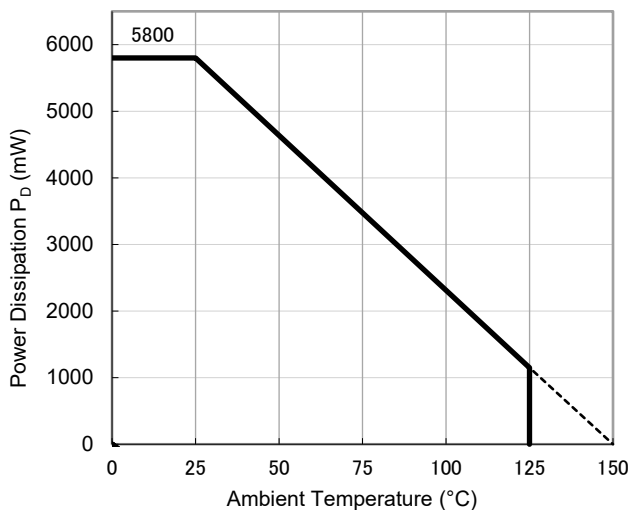

Power Dissipation vs. Ambient Temperature

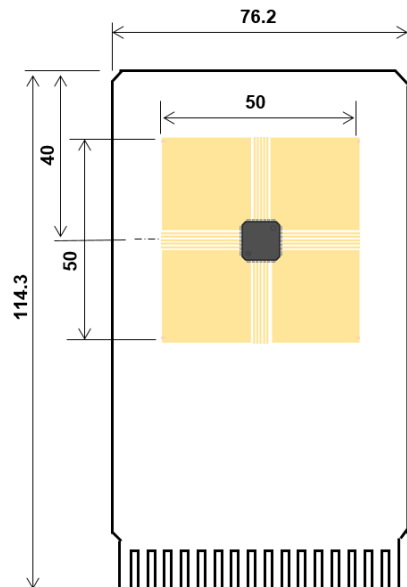

Measurement Board Pattern

1. The products and the product specifications described in this document are subject to change or discontinuation of production without notice for reasons such as improvement. Therefore, before deciding to use the products, please refer to our sales representatives for the latest information thereon.
2. The materials in this document may not be copied or otherwise reproduced in whole or in part without the prior written consent of us.
3. This product and any technical information relating thereto are subject to complementary export controls (so-called KNOW controls) under the Foreign Exchange and Foreign Trade Law, and related politics ministerial ordinance of the law. (Note that the complementary export controls are inapplicable to any application-specific products, except rockets and pilotless aircraft, that are insusceptible to design or program changes.) Accordingly, when exporting or carrying abroad this product, follow the Foreign Exchange and Foreign Trade Control Law and its related regulations with respect to the complementary export controls.
4. The technical information described in this document shows typical characteristics and example application circuits for the products. The release of such information is not to be construed as a warranty of or a grant of license under our or any third party's intellectual property rights or any other rights.
5. The products listed in this document are intended and designed for automotive applications. Those customers intending to use a product in an application requiring extreme quality and reliability, for example, in a highly specific application where the failure or misoperation of the product could result in human injury or death should first contact us.
 - Aerospace Equipment
 - Equipment Used in the Deep Sea
 - Power Generator Control Equipment (nuclear, steam, hydraulic, etc.)
 - Life Maintenance Medical Equipment
 - Fire Alarms / Intruder Detectors
 - Vehicle Control Equipment (airplane, railroad, ship, etc.)
 - Various Safety Devices
 - Traffic control system
 - Combustion equipment

In case your company desires to use this product for any applications other than general electronic equipment mentioned above, make sure to contact our company in advance. Note that the important requirements mentioned in this section are not applicable to cases where operation requirements such as application conditions are confirmed by our company in writing after consultation with your company.

6. We are making our continuous effort to improve the quality and reliability of our products, but semiconductor products are likely to fail with certain probability. In order to prevent any injury to persons or damages to property resulting from such failure, customers should be careful enough to incorporate safety measures in their design, such as redundancy feature, fire containment feature and fail-safe feature. We do not assume any liability or responsibility for any loss or damage arising from misuse or inappropriate use of the products.
7. The products have been designed and tested to function within controlled environmental conditions. Do not use products under conditions that deviate from methods or applications specified in this datasheet. Failure to employ the products in the proper applications can lead to deterioration, destruction or failure of the products. We shall not be responsible for any bodily injury, fires or accident, property damage or any consequential damages resulting from misuse or misapplication of the products.
8. Quality Warranty
 - 8-1. Quality Warranty Period

In the case of a product purchased through an authorized distributor or directly from us, the warranty period for this product shall be one (1) year after delivery to your company. For defective products that occurred during this period, we will take the quality warranty measures described in section 8-2. However, if there is an agreement on the warranty period in the basic transaction agreement, quality assurance agreement, delivery specifications, etc., it shall be followed.
 - 8-2. Quality Warranty Remedies

When it has been proved defective due to manufacturing factors as a result of defect analysis by us, we will either deliver a substitute for the defective product or refund the purchase price of the defective product.
Note that such delivery or refund is sole and exclusive remedies to your company for the defective product.
 - 8-3. Remedies after Quality Warranty Period

With respect to any defect of this product found after the quality warranty period, the defect will be analyzed by us. On the basis of the defect analysis results, the scope and amounts of damage shall be determined by mutual agreement of both parties. Then we will deal with upper limit in Section 8-2. This provision is not intended to limit any legal rights of your company.
9. Anti-radiation design is not implemented in the products described in this document.
10. The X-ray exposure can influence functions and characteristics of the products. Confirm the product functions and characteristics in the evaluation stage.
11. WLCSP products should be used in light shielded environments. The light exposure can influence functions and characteristics of the products under operation or storage.
12. Warning for handling Gallium and Arsenic (GaAs) products (Applying to GaAs MMIC, Photo Reflector). These products use Gallium (Ga) and Arsenic (As) which are specified as poisonous chemicals by law. For the prevention of a hazard, do not burn, destroy, or process chemically to make them as gas or power. When the product is disposed of, please follow the related regulation and do not mix this with general industrial waste or household waste.
13. Please contact our sales representatives should you have any questions or comments concerning the products or the technical information.



Nisshinbo Micro Devices Inc.

Official website

<https://www.nisshinbo-microdevices.co.jp/en/>

Purchase information

<https://www.nisshinbo-microdevices.co.jp/en/buy/>