



## ABSTRACT

This manual describes the design, setup and function of the DP83TG720 G-Bit Media Converter. This Media Converter converts a Standard G-Bit Ethernet Stream to a G-Bit Ethernet Stream over unshielded/shielded single-twisted pair cable. The converter offers further multiple support and debugging functions.

---

## Table of Contents

<b>1 Introduction</b> .....	2
1.1 Overview.....	2
1.2 Hardware Features.....	2
1.3 Software Features.....	2
1.4 Block Diagram.....	3
<b>2 Board Overview</b> .....	4
2.1 Components.....	4
2.2 Connectivity.....	5
<b>3 Quick Start</b> .....	6
3.1 Jumper and DIP-Switch Settings.....	6
3.2 USB 2 MDIO Tool for Debugging and Configuration.....	6
<b>4 Configuration</b> .....	7
4.1 Default Configuration.....	7
4.2 DIP-Switches and Operation Modes.....	7
4.3 DIP-Switch Settings Overview.....	7
<b>5 Update MSP430 Software Using UniFlash</b> .....	8
<b>6 Schematic, Board Layout, and Bill of Materials</b> .....	11
6.1 Schematic.....	11
6.2 Board Layout.....	14
6.3 Bill of Materials.....	15

## Trademarks

All trademarks are the property of their respective owners.

# 1 Introduction

## 1.1 Overview

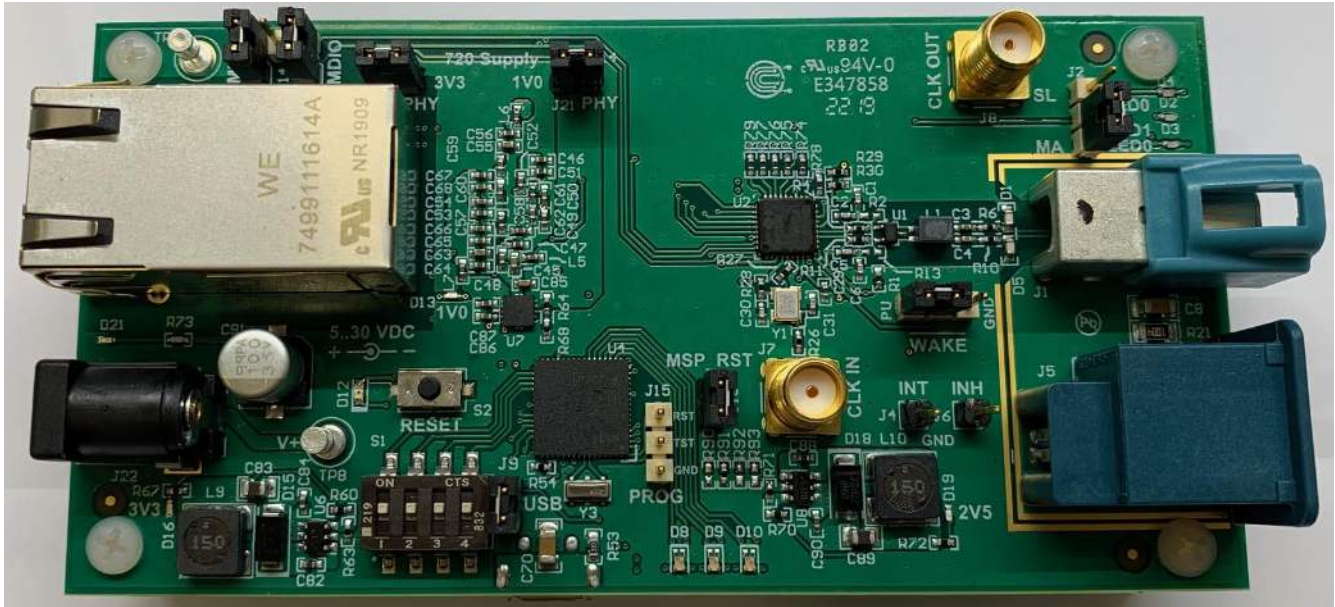

**Figure 1-1. Ethernet Media Converter Board**

This Media Converter is a tool to connect automotive gigabit Ethernet network to a 1000BASE-T1 twisted pair network using the DP83TG720-Q1 automotive Ethernet PHY. It is an easy way to evaluate the functionality of the DP83TG720-Q1 PHY within a standard computer network environment.

The Media Converter is supported by USB-2-MDIO Tool, a command line Interface and DIEP, a user interface for reading and writing all control and status registers of PHYs over a USB connection for simple debugging and startup, on this board from the DP83TG720 and the DP83867 PHY.

For easy testing and development, this converter also comes with a pre-programmed MSP430, with different modes which can be selected via four DIP-Switches. It is possible to select from a standard configuration of the PHYs

For simple debugging, the converter provides onboard LEDs to show link quality and which mode is selected. Further at the RJ45 Jack are LEDs to show speed selection and data transfer.

When more detailed information is required, the converter can send status and error information via USB to a simple terminal program.

## 1.2 Hardware Features

DP83TG720-Q1 media converter features:

- USB interface for easy configuration and debugging and for supply voltage.
- Supports TE Matenet and Rosenberger H-MTD connector (optional).
- Standalone operation mode with two predefined configurations.
- LEDs giving status information for different operation modes.
- Power connector for external 5 V DC to 30 V DC supply. The MC draws about 1.2 W .
- SMA female plug for Ext. CLK\_in and CLK\_out.

### Note

To prevent damage, the voltage applied to the power connector must not exceed 30V DC.

## 1.3 Software Features

- All MDIO registers can be accessed via USB interface.

- One preprogrammed configuration for master and slave, available in normal- or sleep-mode.
- Normal mode:
  - Full register access via USB to MDIO software.
  - Simple terminal connection via USB for status information, error reporting and full register access.
  - MCU can send detailed status information about the PHYs via USB.
- Sleep mode :
  - MCU is shut down after configuring the PHYs.

### 1.4 Block Diagram

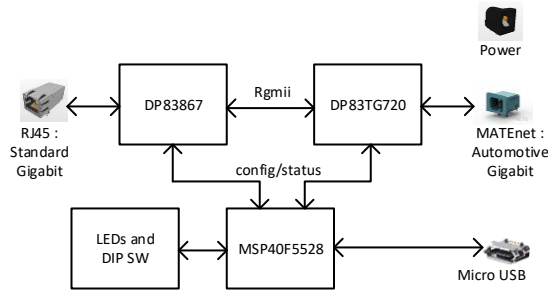

**Figure 1-2. Block Diagram**

## 2 Board Overview

### 2.1 Components

Figure below gives a quick overview of the media converter board. The marked sections are described in the table below.

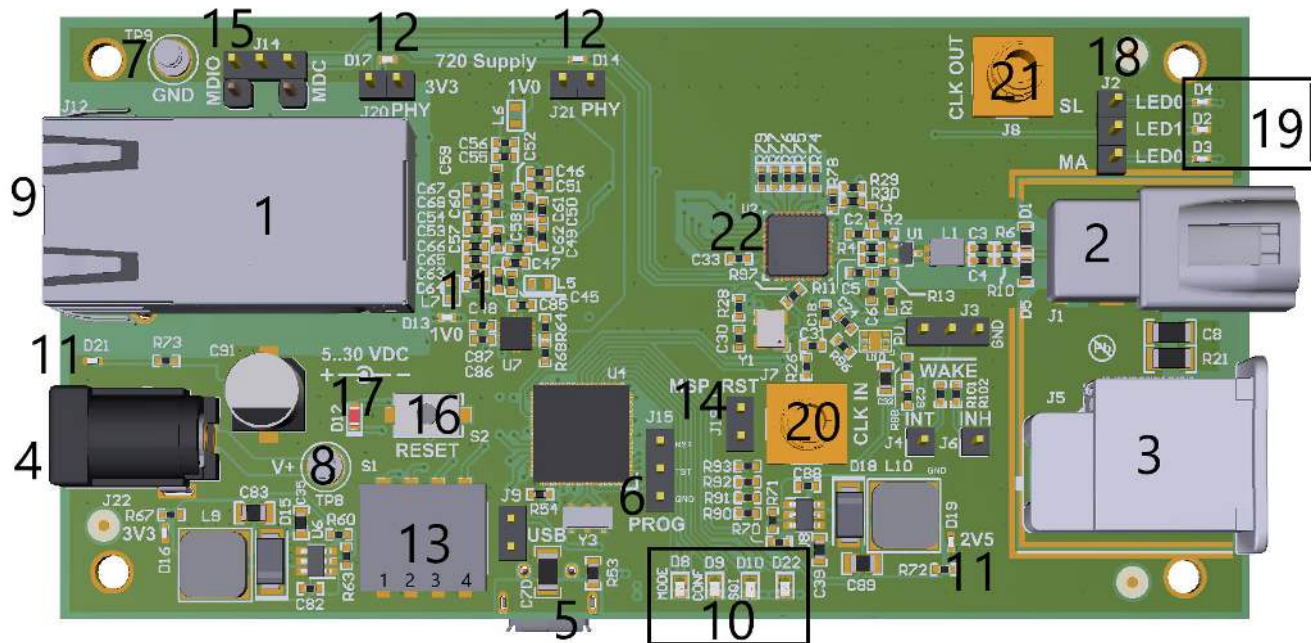

Figure 2-1. Connectors, Jumpers and LEDs

Table 2-1. Component Table

Section	Description
1	RJ45 G-Bit network connection
2	TE Matenet connector for automotive ethernet
3	Rosenberger H-MTD connector for automotive ethernet
4	5 VDC to 30 VDC auxiliary power connector. Maximum current consumption <= 500 mA
5	Micro USB connector for power supply and debugging
6	Spy-Bi-Wire JTAG connector for programming the MSP430
7	GND test connection for supply voltage or measuring
8	V+ test connection for supply voltage (5-30V) or measuring
9	867 PHY status indicator LEDs at RJ45 connector: <ul style="list-style-type: none"> <li>Green LED: on when 1000Base-T link established</li> <li>Yellow LED: on when 100Base-T link established</li> <li>Orange LED: blinks while transmit/receive activity</li> </ul>
10	<ul style="list-style-type: none"> <li>D8 on green when in normal mode.</li> <li>D8 on red when in sleep mode .</li> <li>D9 on green when standard configuration script applied.</li> <li>D10 depends on signal quality indicator : <ul style="list-style-type: none"> <li>Red = Bad</li> <li>Red and Green = Good</li> <li>Green = Excellent</li> </ul> </li> </ul>

**Table 2-1. Component Table (continued)**

Section	Description
11	Power indicator LEDs. <ul style="list-style-type: none"> <li>• D21 : Auxiliary power supply indicator</li> <li>• D23 : 1V indicator</li> <li>• D11 : 2.5V indicator</li> <li>• D16 : 3.3V indicator</li> </ul>
12	Power connection jumpers. The DP83TG720 power rail can be disconnected via the corresponding power jumper : <ul style="list-style-type: none"> <li>• J20 : 3.3V supply connection.</li> <li>• J21 : 1V supply connection.</li> </ul>
13	DIP-Switches for board configuration selection.
14	MSP430 Reset jumper J19 (disconnect when programming)
15	MDIO jumpers (J14). These jumpers determine the MDIO interface.
16	Reset button. Performs a power on reset.
17	Reset indicator LED
18	720 PHY Master/Slave selection jumper (J2). <ul style="list-style-type: none"> <li>• J2 set to 1-2 : 720 is Master</li> <li>• J2 set to 2-3 the 720 is Slave</li> </ul>
19	720 PHY status indicator LEDs: <ul style="list-style-type: none"> <li>• D2 lights up when Link is Down. Blinks while transmit/receive activity.</li> <li>• D3 lights up when Link is established and 720 is Master.</li> <li>• D4 lights up when Link is established and 720 is Slave</li> </ul>
20	SMA connector (J21) for external CLOCK_IN for 720 PHY, when no crystal is installed and R26 (0 ohms) is placed.
21	DP83TG720 Ethernet PHY.

## 2.2 Connectivity

### 2.2.1 Network Interfaces

This converter board has (configurable with 0 ohm resistors) a TE Matenet or Rosenberger H-MTD connector for automotive network connection and a RJ45 connector for twisted pair network connection. **Be aware that this adapter supports 1 Gbit only on both connectors. 10/100 Mbit connections are not supported.**

### 2.2.2 USB Connection

The USB connector on this board is used for MDIO communication, getting debug information and to power the board. For MDIO communication, either USB2MDIO Tool or any terminal program set to 115200 baud can be used to access all registers of the 720 and 867 PHYs.

### 2.2.3 Power Connection

The Media Converter can be powered via USB or via a 5 V DC to 30 V DC source applied to the dedicated power connection. The maximum voltage applied to the dedicated power connector must not exceed 30 V DC. The power connector and USB connector can be used simultaneously.

## 3 Quick Start

### 3.1 Jumper and DIP-Switch Settings

Before using the Media Converter the default settings should be verified.

**Table 3-1. Media Converter Default Settings**

Component	Type	Setting	Description
S1	DIP-Switch	<ul style="list-style-type: none"> <li>SW1=1</li> <li>SW2=1</li> <li>SW3=1</li> <li>SW4=1</li> </ul>	Normal mode standard configuration master/slave.
J2	Header-Pins	<ul style="list-style-type: none"> <li>Placed 1-2 : Configure 720 as Master</li> <li>Placed 2-3 : Configure 720 as Slave</li> </ul>	
J14	Header-Pins	<ul style="list-style-type: none"> <li>J14.1-J16.1</li> <li>J14.3-J17.1</li> </ul>	Connect MDC and MDIO from PHY to MSP
J15	Header-Pins	Not placed	Programming connector
J19	Header-Pins	Placed 1-2	Reset connector. Remove for programming
J20	Header-Pins	Placed 1-2	Power connector 3.3V 720 PHY
J21	Header-Pins	Placed 1-2	Power connector 1.0V 720 PHY
J9	Header-Pins	Placed 1-2	Power connector USB_VBUS
R6 and R10	Resistors	Populated for Rosenberger H-MTD	make sure, R8 and R9 are not populated
R8 and R9	Resistors	Populated for TE Matenet	make sure, R6 and R10 (SGMII 0: R11) are not populated
R74 to R85	Resistors	Populated	populated to connect 720 to 867 via RGMII
R95	Resistor	Populated	720 RGMII align Mode strap
R94 and R33	Resistor	Populated	867 RGMII Mirror Enable

### 3.2 USB 2 MDIO Tool for Debugging and Configuration

Open the USB2MDIO tool and under Settings select Baud Rate = 9600 plus the COM Port of the desired USB Port.

The correct USB Port can be found in the Device Manager under Ports (COM & LTP) :

- Windows 7 and older → **TI:USB-2-MDIO (COMXXX)**.
- Windows 10 → **USB Serial Device (COMXXX)**.

After that press Open Port.

Now either File à Find PHY ID is available or if already known, the PHY ID can be directly selected from the drop-down menu.

**The PHY-ID of the DP83867867 PHY is 0x00.**

**The PHY-ID of DP83TG720 PHY is 0x08.**

Now enter the register to read or write a value.

## 4 Configuration

### 4.1 Default Configuration

### 4.2 DIP-Switches and Operation Modes

The four DIP-Switches on the media converter board are used to select the desired operation mode and configuration. Possible operation modes are:

**Normal mode:** In this standalone mode, the onboard MCU configures the PHY based on the selected settings and shows status information with the onboard LEDs. LED8 green for normal mode, LED9 green for standard configuration applied. When SW 2 off, LED10 on depending of signal quality indicator from 720 PHY MDI side.

**Normal mode without configuration:** LED8 green for normal mode, LED 9 red for non-configuration applied. When SW 2 off, LED10 on depending of signal quality indicator from 720 PHY MDI side.

**Sleep Mode (for EMI testing):** Standalone mode. After applying the selected configuration, the MCU shuts down to minimize EMI emissions. The sleep mode is indicated via LED8 (on) in red.

### 4.3 DIP-Switch Settings Overview

The table below lists all possible DIP-Switch (S1) settings from the previous description.

**Table 4-1. List of DIP Switch Settings**

Mode Number	Configuration Mode	<SW1, SW2,SW3,SW4>
15	Normal mode with initialization script for master/slave, full duplex with USB debug	1,1,1,1
14	Normal mode without initialization script configuration, with USB debug	0,1,1,1
13	Same as mode 15. D10 shows MDI Link Quality.	1,0,1,1
12	Same as mode 12. D10 shows MDI Link Quality	0,0,1,1
7	Sleep mode with initialization script master/ slave, full duplex.	1,1,1,0
7	Sleep mode without initialization script configuration, full duplex.	0,1,1,0

---

**Note**

Once the sleep mode is selected, a reset must be performed to select another operation mode.

---

**Note**

MDI Link Quality produces traffic on MDIO, loading a script with USB2MDIO Tool will not work with mode number 12 and 13.

---

## 5 Update MSP430 Software Using UniFlash

To Update the Software that runs on the MSP430 on the Media Converter there is the Software UNIFLASH available. The Software can be downloaded from:

<http://www.ti.com/tool/UNIFLASH>.

The User's Guide can be found here: [http://downloads.ti.com/ccs/esd/uniflash/docs/latest\\_qsguide.html](http://downloads.ti.com/ccs/esd/uniflash/docs/latest_qsguide.html).

The MSP430 Launchpad including the eZ-FET can be used as a Programmer for external MSP430 devices, and so, the MSP430F5528 can get programmed on the 720 Media Converter.

<http://www.ti.com/tool/MSP-EXP430F5529LP>.

### Launchpad preparations:

Remove all stock jumpers marked in blue and connect as stated in this table:

**Table 5-1. Wiring Table**

Launchpad	720 Media Converter
GND	GND
SBW TST (SBWTCK)	TST
SBW RST (SBWTDIO)	RST



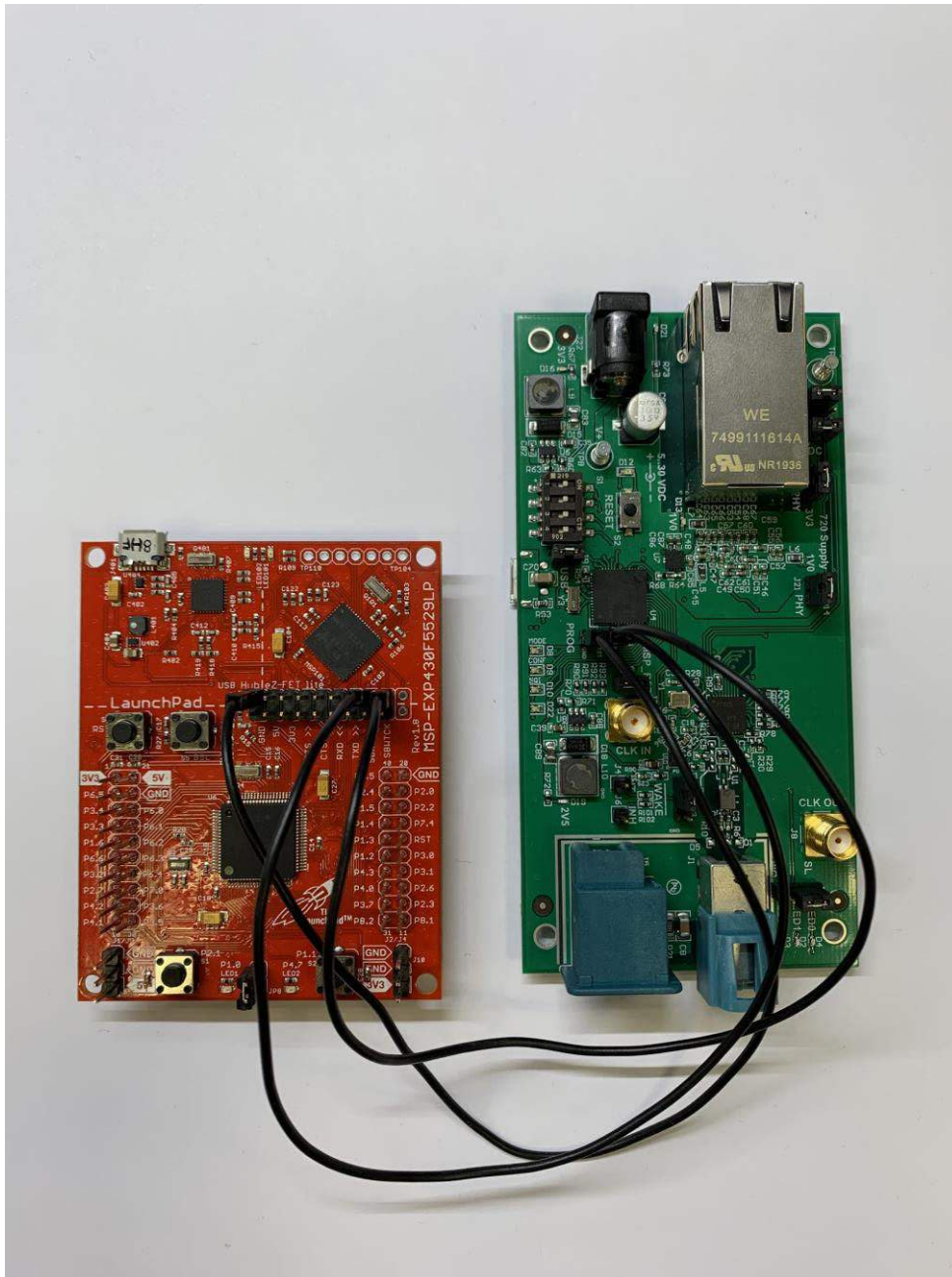

**Figure 5-1. Launchpad Connected To 720 Media Converter**

Connect the MSP430 Launchpad and the 720 Media Converter to the Computer and open UniFlash. UniFlash should now Auto-Detect the MSP430F5528.

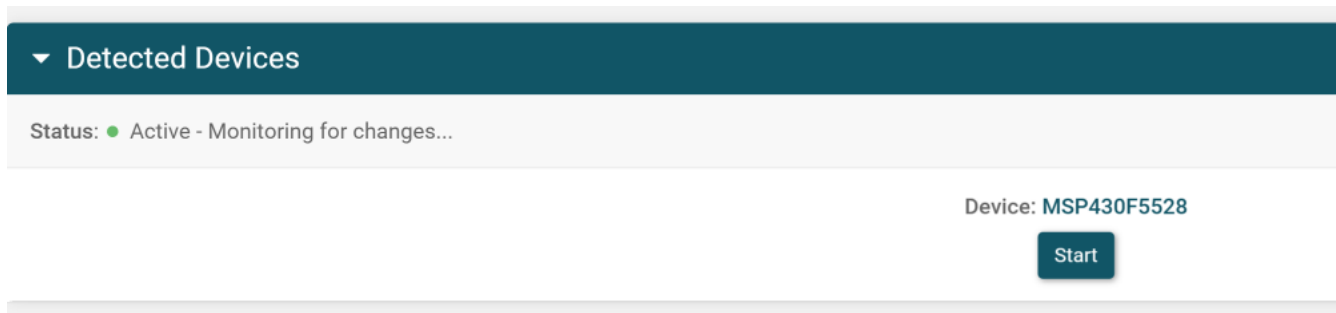
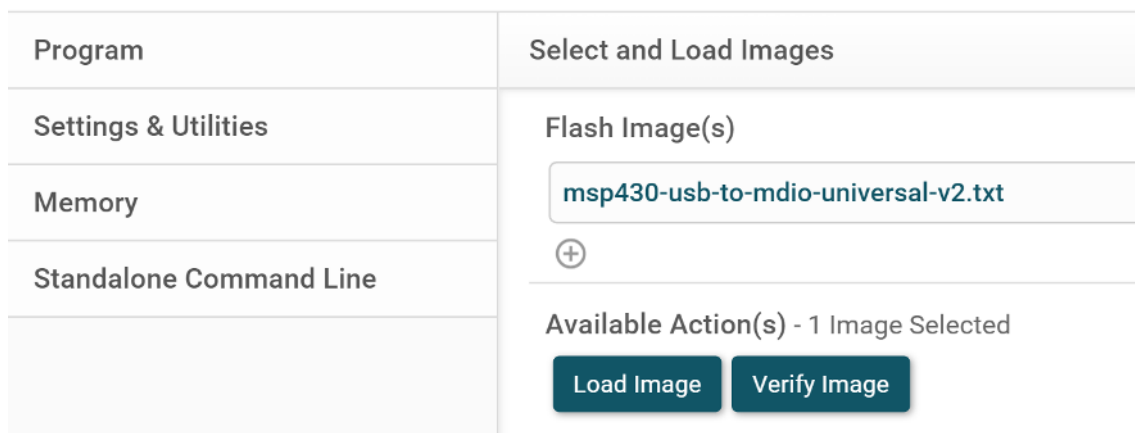

**Figure 5-2. Uniflash : Device Detection**

Click Start.

Now browse for the Flash File :

Configured Device : TI MSP430 USB1 > MSP430F5528 [\[more info\]](#) [\[download ccxml\]](#)



**Figure 5-3. Uniflash : Flash File**

Press load image to flash the file to the MSP430F5528 on the 720 Media Converter.

## 6 Schematic, Board Layout, and Bill of Materials

### 6.1 Schematic

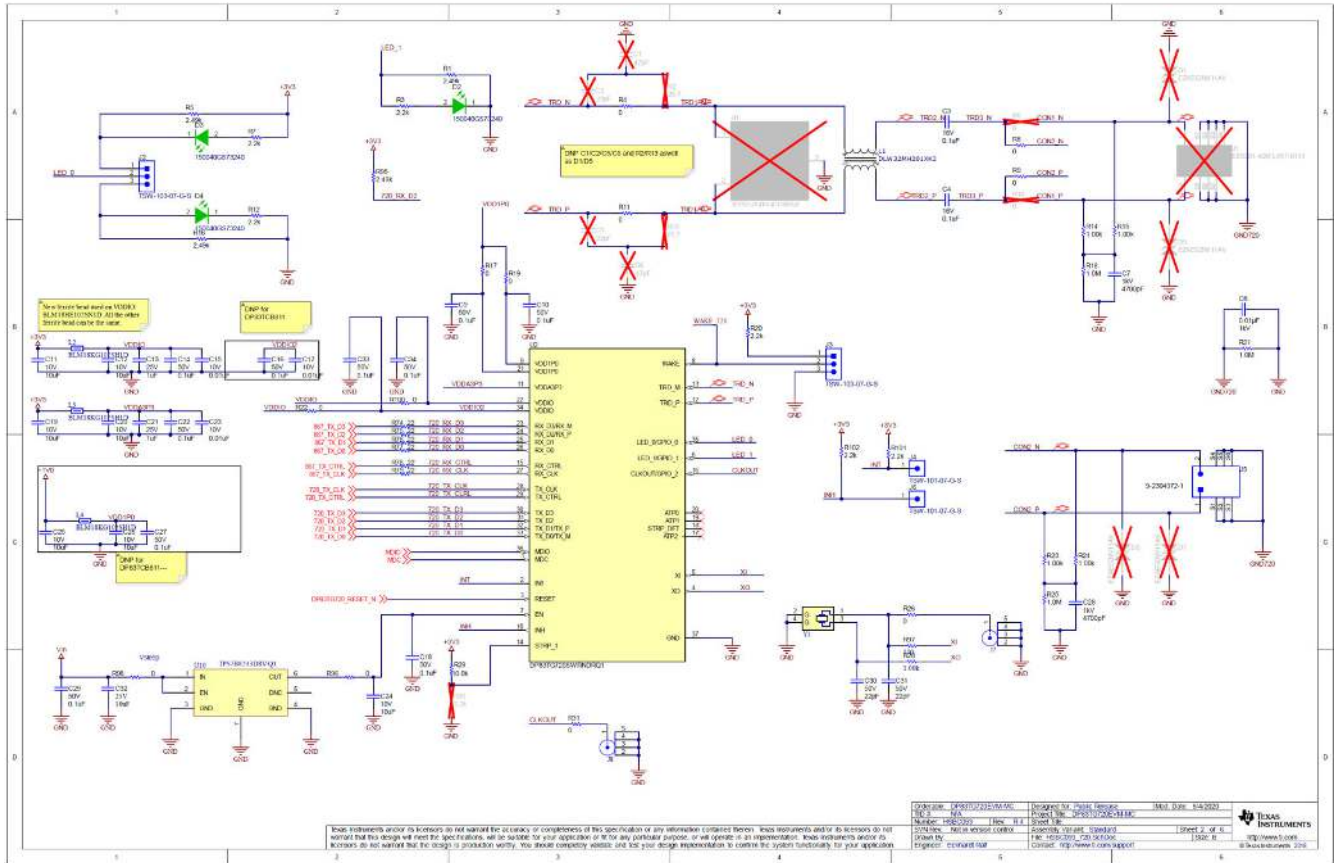

Figure 6-1. Schematic : DP83TG720 Schematic



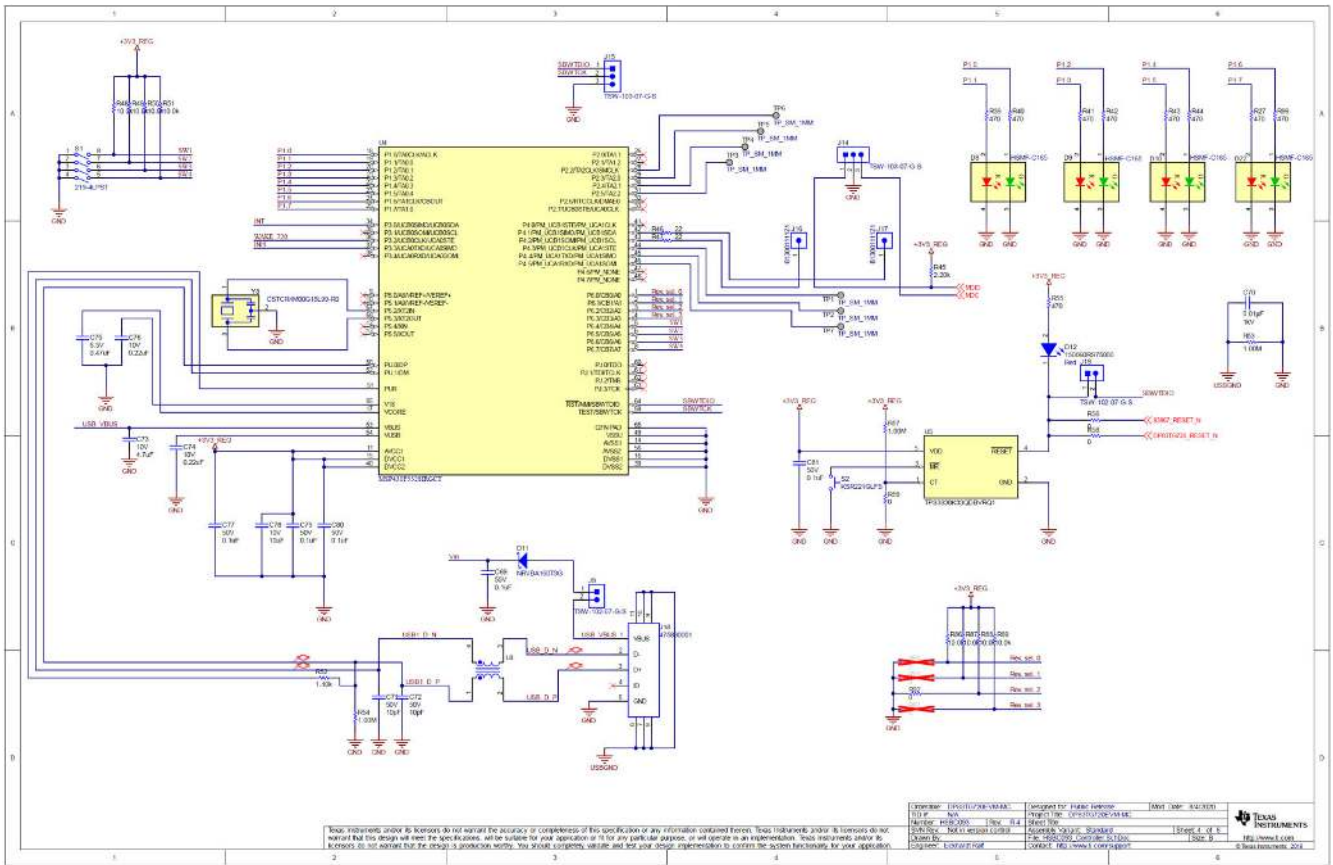

Figure 6-3. Schematic : MCU

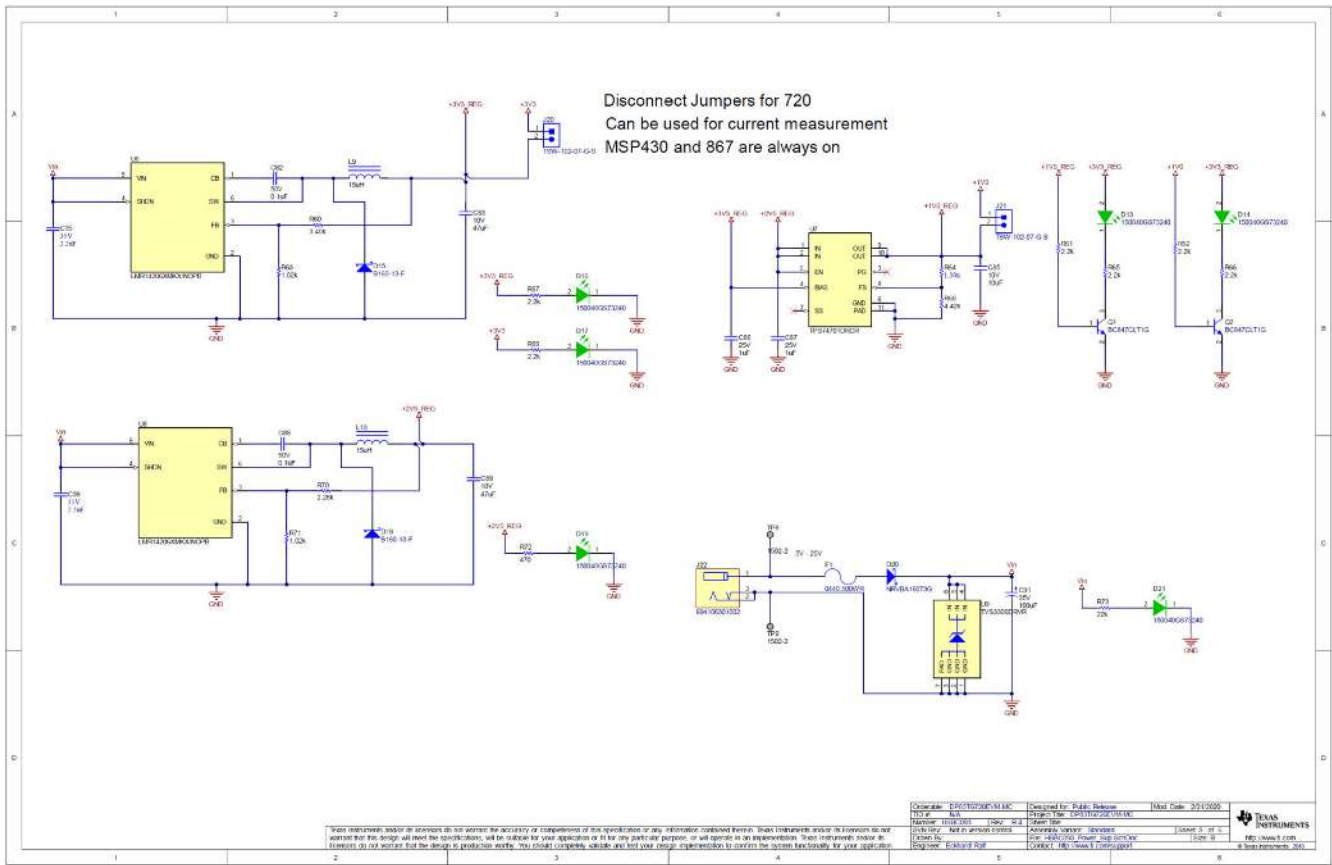

Figure 6-4. Schematic : Power

## 6.2 Board Layout

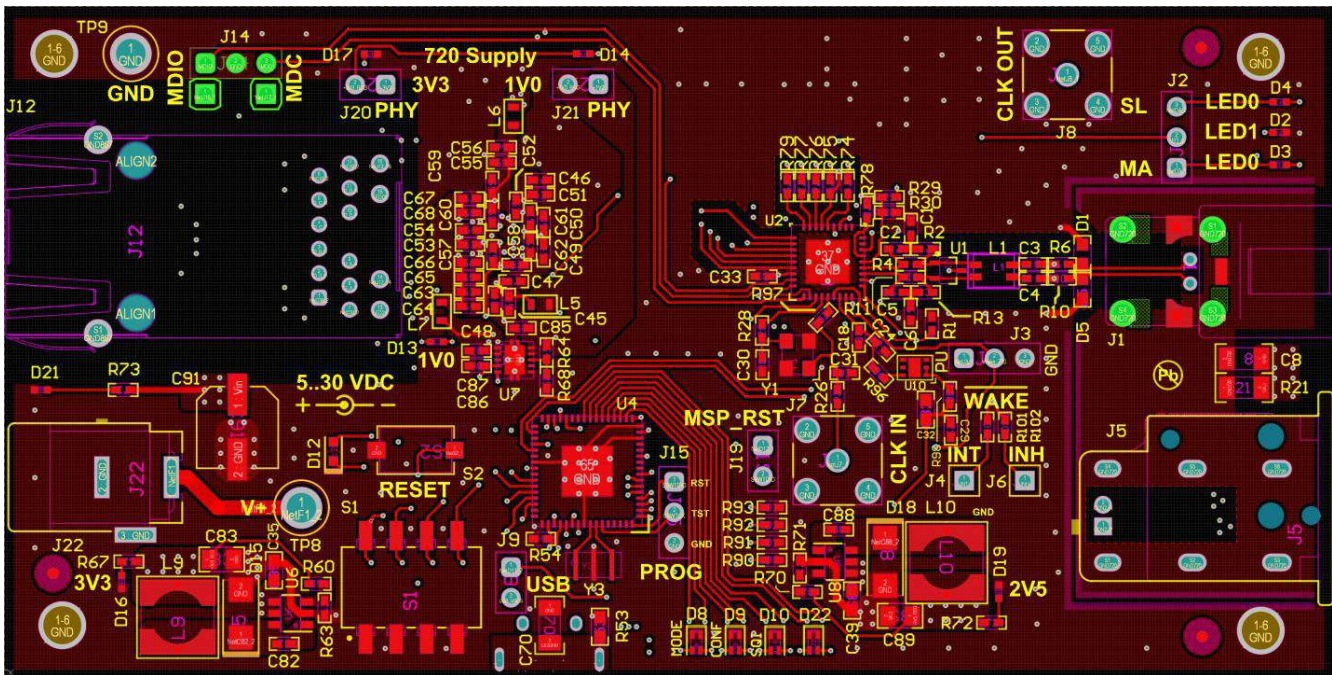

Figure 6-5. Top Layer

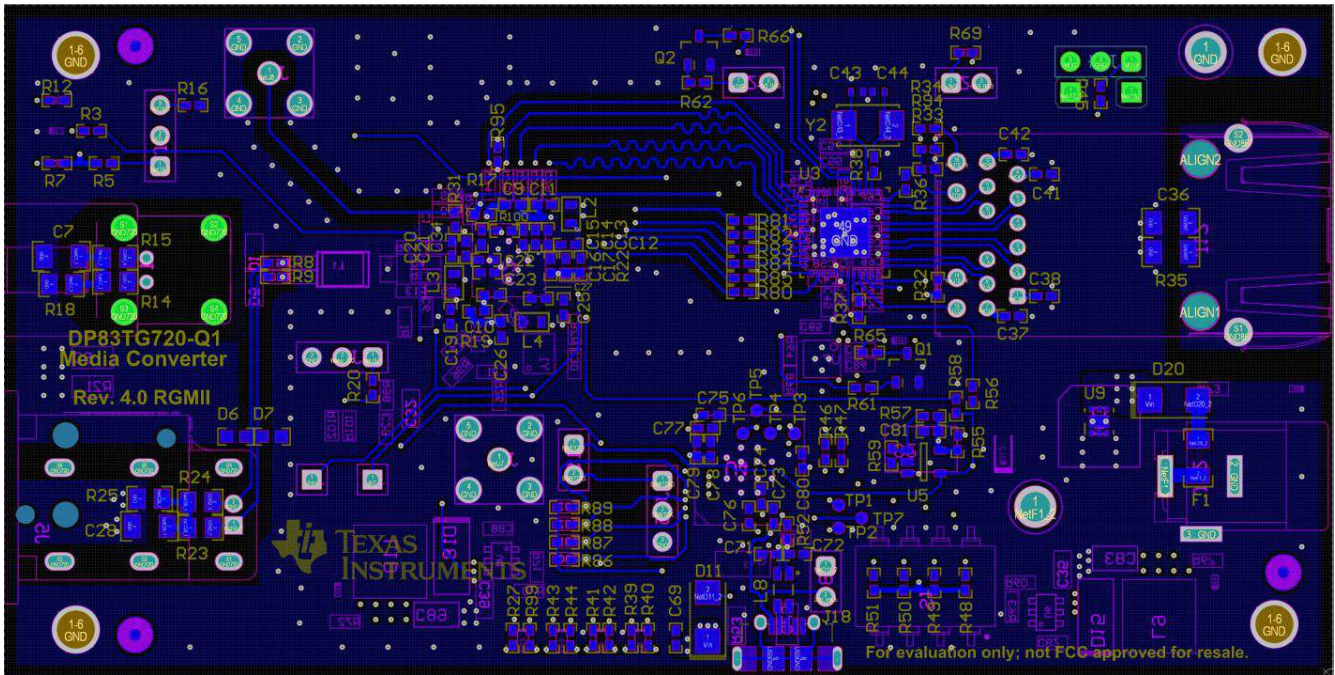

Figure 6-6. Bottom Layer

### 6.3 Bill of Materials

Designator	Quantity	Part Number	Description	Footprint
Y3	1	CSTCR4M00G15L99-R0	Resonator, 4 MHz, 1000 ppm, 39 pF, SMD	Murata_CSTCR_G15L
Y2	1	NX5032GA-25.000M-STD-CSK-4	Crystal, 25 MHz, SMD	NDK_NX5032GA
Y1	1	ABM8AIG-25.000MHZ-12-2Z-T3	Crystal, 25 MHz, 12pF, AEC-Q200 Grade 1, SMD	Abracon_ABM8AIG
U10	1	TPS7B8233DRV-Q1	300-mA High-Voltage Ultralow-IQ Low-Dropout Regulator	PCBComponent_1
U9	1	TVS3300DRVR	33-V Precision Surge Protection Clamp, DRV0006A (WSON-6)	DRV0006A
U7	1	TPS74701DRCR	Single Output LDO, 500mA, Adj. (0.8 to 3.6V), Programmable Soft-Start, DRC0010J (VSON-10)	DRC0010J
U6, U8	2	LMR14206XMKX/NOPB	SIMPLE SWITCHER(R) 4.5V to 42V, 0.6A Step-Down DC/DC Switching Regulator in SOT-23 Package, DDC0006A (SOT-23-T-6)	DDC0006A_N
U5	1	TPS3838K33QDBVRQ1	Nanopower Supervisory Circuits for Automotive, DBV0005A (SOT-23-5)	DBV0005A_N

Designator	Quantity	Part Number	Description	Footprint
U4	1	MSP430F5528IRGCT	16-Bit Ultra-Low-Power Microcontroller, 128KB Flash, 8KB RAM, USB, 12Bit ADC, 2 USCIs, 32Bit HW MPY, RGC0064B (VQFN-64)	RGC0064B
U3	1	DP83867ERGZR	Extended Temperature Gigabit Ethernet PHY with SGMII, RGZ0048B (VQFN-48)	RGZ0048B
U2	1	DP83TG720SWRNDRQ1	Low Power Auto PHY 1000BASE-T1 Automotive Ethernet Physical Layer Transceiver, RND0036A (VQFNP-36)	RND0036A
TP8, TP9	2	1502-2	Terminal, Turret, TH, Double	Keystone1502-2
S2	1	KSR221GLFS	Switch, Normally open, 2.3N force, 200k operations, SMD	KSR
S1	1	219-4LPST	Switch, SPST 4 Pos, Top Actuated, SMT	SW_219-4LPST
R97	1	CRCW0402100RFKED	RES, 100, 1%, 0.063 W, AEC-Q200 Grade 0, 0402	0402
R94	1	CRCW04025K76FKED	RES, 5.76 k, 1%, 0.063 W, AEC-Q200 Grade 0, 0402	0402
R74, R75, R76, R77, R78, R79, R80, R81, R82, R83, R84, R85	12	CRCW040222R0JNED	RES, 22, 5%, 0.063 W, 0402	0402
R73	1	CRCW040222K0JNED	RES, 22 k, 5%, 0.063 W, AEC-Q200 Grade 0, 0402	0402
R70	1	CRCW04022K26FKED	RES, 2.26 k, 1%, 0.063 W, AEC-Q200 Grade 0, 0402	0402
R68	1	CRCW04024K42FKED	RES, 4.42 k, 1%, 0.063 W, AEC-Q200 Grade 0, 0402	0402
R64	1	CRCW04021K30FKED	RES, 1.30 k, 1%, 0.063 W, AEC-Q200 Grade 0, 0402	0402
R63, R71	2	CRCW04021K02FKED	RES, 1.02 k, 1%, 0.063 W, AEC-Q200 Grade 0, 0402	0402
R60	1	CRCW04023K40FKED	RES, 3.40 k, 1%, 0.063 W, AEC-Q200 Grade 0, 0402	0402
R54, R57	2	ERJ-2RKF1004X	RES, 1.00 M, 1%, 0.1 W, 0402	0402
R53	1	RMCF0603FG1M00	RES, 1.00 M, 1%, 0.1 W, AEC-Q200 Grade 0, 0603	0603
R52	1	CRCW04021K40FKED	RES, 1.40 k, 1%, 0.063 W, AEC-Q200 Grade 0, 0402	0402



Designator	Quantity	Part Number	Description	Footprint
R46, R47	2	ERJ-2GEJ220X	RES, 22, 5%, 0.1 W, AEC-Q200 Grade 0, 0402	0402
R37, R45	2	ERJ-2RKF2201X	RES, 2.20 k, 1%, 0.1 W, 0402	0402
R36	1	CRCW040211K0FKED	RES, 11.0 k, 1%, 0.063 W, AEC-Q200 Grade 0, 0402	0402
R29, R48, R49, R50, R51, R86, R87, R88, R89	9	RT0402BRD0710KL	RES, 10.0 k, .1%, .0625 W, 0402	0402
R28	1	CRCW04021K00FKED	RES, 1.00 k, 1%, 0.063 W, AEC-Q200 Grade 0, 0402	0402
R27, R32, R34, R39, R40, R41, R42, R43, R44, R55, R72, R99	12	RC0402FR-07470RL	RES, 470, 1%, 0.063 W, 0402	0402
R26, R31	2	ERJ-2GE0R00X	RES, 0, 5%, 0.1 W, AEC-Q200 Grade 0, 0402	0402
R21, R35	2	CRCW12061M00JNEA	RES, 1.0 M, 5%, 0.25 W, AEC-Q200 Grade 0, 1206	1206
R18, R25	2	CRCW08051M00JNEA	RES, 1.0 M, 5%, 0.125 W, AEC-Q200 Grade 0, 0805	0805_HV
R14, R15, R23, R24	4	ERJ-P06F1001V	RES, 1.00 k, 1%, 0.25 W, 0805	0805_HV
R4, R8, R9, R11, R17, R19, R22, R38, R56, R58, R59, R92, R96, R98, R100	15	CRCW04020000Z0EDHP	RES, 0, 0%, 0.2 W, AEC-Q200 Grade 0, 0402	0402
R3, R7, R12, R20, R61, R62, R65, R66, R67, R69, R101, R102	12	CRCW04022K20JNED	RES, 2.2 k, 5%, 0.063 W, AEC-Q200 Grade 0, 0402	0402
R1, R5, R16, R33, R95	5	CRCW04022K49FKED	RES, 2.49 k, 1%, 0.063 W, AEC-Q200 Grade 0, 0402	0402
Q1, Q2	2	BC847CLT1G	Transistor, NPN, 45 V, 0.1 A, SOT-23	SOT-23
L9, L10	2	744053150	Inductor, Shielded Drum Core, Ferrite, 15 uH, 1.15 A, 0.07 ohm, SMD	WE-TPC-LH
L8	1	744232090	Coupled inductor, A, 0.3 ohm, SMD	WE-CNSW_1206
L2, L3, L4, L5, L6, L7	6	BLM18KG102SH1D	FERRITE BEAD 1 KOHM 0603 1LN	Ferrit Bead
L1	1	DLW32MH201XK2	200µH @ 100kHz 2 Line Common Mode Choke Surface Mount 70mA DCR 4.8 Ohm	FP-DLW32MH201XK2_1210-MFG
J22	1	694106301002	WR-DC DC Power Jack, R/A, TH	Wurth_694106301002
J18	1	475890001	Connector, Receptacle, Micro-USB Type AB, R/A, Bottom Mount SMT	Molex_0475890001

Designator	Quantity	Part Number	Description	Footprint
J16, J17	2	61300111121	Header, 2.54 mm, 1x1, Gold, TH	WURTH_61300111121
J12	1	7499111614A	Connector, 1 Port RJ45, Gold, R/A, TH	Wurth_7499111614A
J9, J19, J20, J21	4	TSW-102-07-G-S	Header, 100mil, 2x1, Gold, TH	TSW-102-07-G-S
J7, J8	2	901-144-8RFX	SMA Straight Jack, Gold, 50 Ohm, TH	AMPHENOL_901-144-8RFX
J5	1	9-2304372-1	Header(shrouded), 2x1, R/A, TH	TE_1PORT_B1-B
J4, J6	2	TSW-101-07-G-S	Header, 100mil, 1pos, Gold, TH	TSW-101-07-G-S
J2, J3, J14, J15	4	TSW-103-07-G-S	Header, 100mil, 3x1, Gold, TH	TSW-103-07-G-S
FID1, FID2, FID3, FID4, FID5, FID6	6	Fiducial	Fiducial mark. There is nothing to buy or mount.	Fiducial10-30
F1	1	0440.500WR	Fuse, 0.5 A, 63VAC/VDC, SMD	1206
D15, D18	2	B160-13-F	Diode, Schottky, 60 V, 1 A, SMA	SMA
D12	1	150060RS75000	LED, Red, SMD	WL-SMCW_RED
D11, D20	2	NRVBA160T3G	Diode, Schottky, 60 V, 1 A, AEC-Q101, SMA	SMA
D8, D9, D10, D22	4	HSMF-C165	LED, Rg, SMD	HSMF-C165_RG
D2, D3, D4, D13, D14, D16, D17, D19, D21	9	150040GS73240	LED, Green, SMD	WL-SMCC_0402_Green
C91	1	EMVA350ADA101MF80G	CAP, AL, 100 uF, 35 V, +/- 20%, SMD	CAPSMT_62_F80
C83, C89	2	C2012X5R1A476M125AC	CAP, CERM, 47 uF, 10 V, +/- 20%, X5R, 0805	0805_HV
C75	1	04026D474KAT2A	CAP, CERM, 0.47 uF, 6.3 V, +/- 10%, X5R, 0402	0402
C74, C76	2	GRM155R61A224KE19D	CAP, CERM, 0.22 uF, 10 V, +/- 10%, X5R, 0402	0402
C73	1	C1005X5R1A475K050BC	CAP, CERM, 4.7 uF, 10 V, +/- 10%, X5R, 0402	0402_065
C71, C72	2	GRM1555C1H100FA01D	CAP, CERM, 10 pF, 50 V, +/- 1%, C0G/NP0, 0402	0402
C43, C44	2	GRM1555C1E270JA01D	CAP, CERM, 27 pF, 25 V, +/- 5%, C0G/NP0, 0402	0402S
C35, C39	2	C1608X5R1V225K080AC	CAP, CERM, 2.2 uF, 35 V, +/- 10%, X5R, 0603	0603
C32	1	C1608X5R1E106M080AC	CAP, CERM, 10 uF, 25 V, +/- 20%, X5R, 0603	0603
C30, C31	2	GRM1555C1H220FA01D	CAP, CERM, 22 pF, 50 V, +/- 1%, C0G/NP0, 0402	0402

Designator	Quantity	Part Number	Description	Footprint
C15, C17, C23, C48, C50, C52, C54, C58, C60, C62, C66, C68	12	GRM155R61A103KA01D	CAP, CERM, 0.01 $\mu$ F, 10 V, +/- 10%, X5R, 0402	0402
C13, C21, C46, C56, C64, C86, C87	7	GRM155R61E105KA12D	CAP, CERM, 1 $\mu$ F, 25 V, +/- 10%, X5R, 0402	0402
C11, C12, C19, C20, C24, C25, C26, C45, C55, C63, C78, C85	12	GRM155R61A106ME11	CAP, CERM, 10 $\mu$ F, 10 V, +/- 20%, X5R, 0402	0402
C9, C10, C14, C16, C18, C22, C27, C29, C33, C34, C37, C38, C41, C42, C47, C49, C51, C53, C57, C59, C61, C65, C67, C69, C77, C79, C80, C81, C82, C88	30	C1005X5R1H104K050BB	CAP, CERM, 0.1 $\mu$ F, 50 V, +/- 10%, X5R, 0402	0402
C8, C36, C70	3	C1206X103KDRAC7800	CAP, CERM, 0.01 $\mu$ F, 1000 V, +/- 10%, X7R, 1206	1206
C7, C28	2	GRM31BR73A472KW01L	CAP, CERM, 4700 pF, 1000 V, +/- 10%, X7R, 1206	1206
C3, C4	2	0402YC104KAT2A	CAP, CERM, 0.1 $\mu$ F, 16 V, +/- 10%, X7R, 0402	0402

## IMPORTANT NOTICE AND DISCLAIMER

TI PROVIDES TECHNICAL AND RELIABILITY DATA (INCLUDING DATA SHEETS), DESIGN RESOURCES (INCLUDING REFERENCE DESIGNS), APPLICATION OR OTHER DESIGN ADVICE, WEB TOOLS, SAFETY INFORMATION, AND OTHER RESOURCES "AS IS" AND WITH ALL FAULTS, AND DISCLAIMS ALL WARRANTIES, EXPRESS AND IMPLIED, INCLUDING WITHOUT LIMITATION ANY IMPLIED WARRANTIES OF MERCHANTABILITY, FITNESS FOR A PARTICULAR PURPOSE OR NON-INFRINGEMENT OF THIRD PARTY INTELLECTUAL PROPERTY RIGHTS.

These resources are intended for skilled developers designing with TI products. You are solely responsible for (1) selecting the appropriate TI products for your application, (2) designing, validating and testing your application, and (3) ensuring your application meets applicable standards, and any other safety, security, regulatory or other requirements.

These resources are subject to change without notice. TI grants you permission to use these resources only for development of an application that uses the TI products described in the resource. Other reproduction and display of these resources is prohibited. No license is granted to any other TI intellectual property right or to any third party intellectual property right. TI disclaims responsibility for, and you will fully indemnify TI and its representatives against, any claims, damages, costs, losses, and liabilities arising out of your use of these resources.

TI's products are provided subject to [TI's Terms of Sale](#) or other applicable terms available either on [ti.com](http://ti.com) or provided in conjunction with such TI products. TI's provision of these resources does not expand or otherwise alter TI's applicable warranties or warranty disclaimers for TI products.

TI objects to and rejects any additional or different terms you may have proposed.

Mailing Address: Texas Instruments, Post Office Box 655303, Dallas, Texas 75265  
Copyright © 2022, Texas Instruments Incorporated