

0.5mm Pitch
SERIES

6223

0.5mmピッチ NON-ZIF RA SMT 上接点
0.5mmPitch LIF RA SMT Top contact

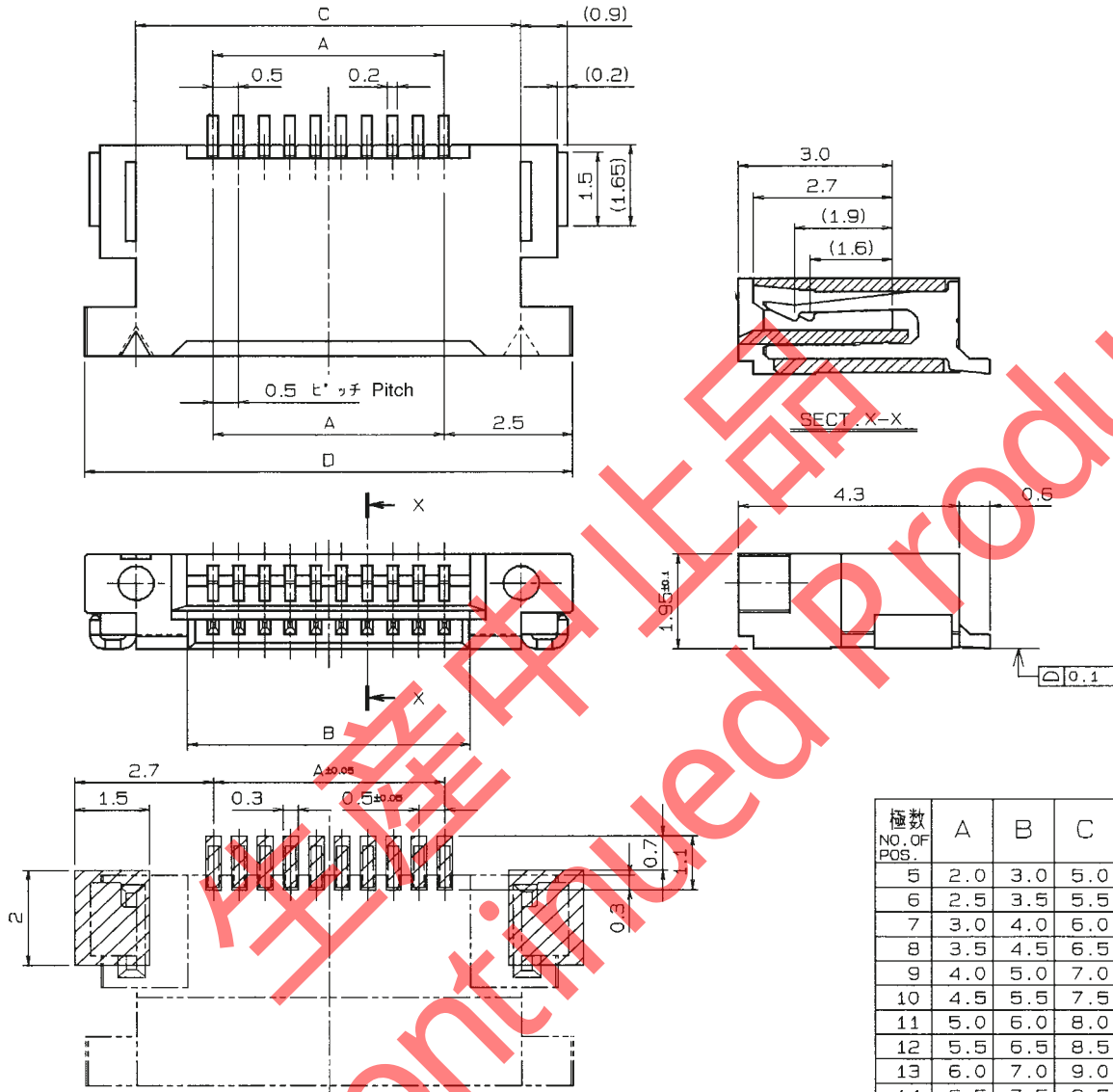

推奨基板取付け寸法 (コネクタ搭載側)
MOUNTING LAYOUT (CONN. MOUNTING SIDE)

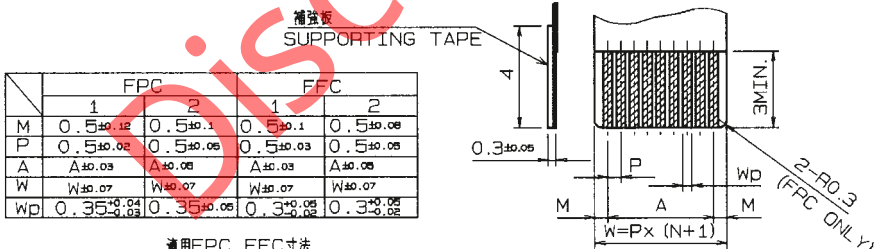

| | FPC | | FFC | |
|----|--|--|---------------------------------------|---------------------------------------|
| | 1 | 2 | 1 | 2 |
| M | 0.5 ^{+0.12} _{-0.08} | 0.5 ^{+0.1} _{-0.08} | 0.5 ^{+0.1} _{-0.08} | 0.5 ^{+0.08} _{-0.05} |
| P | 0.5 ^{+0.02} _{-0.02} | 0.5 ^{+0.05} _{-0.05} | 0.5 ^{+0.03} _{-0.03} | 0.5 ^{+0.05} _{-0.05} |
| A | A ^{+0.03} _{-0.03} | A ^{+0.05} _{-0.05} | A ^{+0.03} _{-0.03} | A ^{+0.05} _{-0.05} |
| W | W ^{+0.07} _{-0.07} | W ^{+0.07} _{-0.07} | W ^{+0.07} _{-0.07} | W ^{+0.07} _{-0.07} |
| WD | 0.35 ^{+0.04} _{-0.03} | 0.35 ^{+0.05} _{-0.05} | 0.3 ^{+0.05} _{-0.05} | 0.3 ^{+0.05} _{-0.05} |

適用FPC, FFC寸法
APPLICABLE FPC, FFC

| 極数 NO. OF POS. | A | B | C | D |
|----------------------|------|------|------|------|
| 5 | 2.0 | 3.0 | 5.0 | 7.0 |
| 6 | 2.5 | 3.5 | 5.5 | 7.5 |
| 7 | 3.0 | 4.0 | 6.0 | 8.0 |
| 8 | 3.5 | 4.5 | 6.5 | 8.5 |
| 9 | 4.0 | 5.0 | 7.0 | 9.0 |
| 10 | 4.5 | 5.5 | 7.5 | 9.5 |
| 11 | 5.0 | 6.0 | 8.0 | 10.0 |
| 12 | 5.5 | 6.5 | 8.5 | 10.5 |
| 13 | 6.0 | 7.0 | 9.0 | 11.0 |
| 14 | 6.5 | 7.5 | 9.5 | 11.5 |
| 15 | 7.0 | 8.0 | 10.0 | 12.0 |
| 16 | 7.5 | 8.5 | 10.5 | 12.5 |
| 17 | 8.0 | 9.0 | 11.0 | 13.0 |
| 18 | 8.5 | 9.5 | 11.5 | 13.5 |
| 19 | 9.0 | 10.0 | 12.0 | 14.0 |
| 20 | 9.5 | 10.5 | 12.5 | 14.5 |
| 21 | 10.0 | 11.0 | 13.0 | 15.0 |
| 22 | 10.5 | 11.5 | 13.5 | 15.5 |
| 23 | 11.0 | 12.0 | 14.0 | 16.0 |
| 24 | 11.5 | 12.5 | 14.5 | 16.5 |
| 25 | 12.0 | 13.0 | 15.0 | 17.0 |
| 26 | 12.5 | 13.5 | 15.5 | 17.5 |
| 27 | 13.0 | 14.0 | 16.0 | 18.0 |
| 28 | 13.5 | 14.5 | 16.5 | 18.5 |
| 29 | 14.0 | 15.0 | 17.0 | 19.0 |
| 30 | 14.5 | 15.5 | 17.5 | 19.5 |

注文コード ORDERING CODE
08 6223 0XX 101 XXX+

RoHS 対応品
RoHS Compliant Product

800+ : スズ銅めっき Sn-Cu Plated
829+ : 金めっき Au Plated

極数 NUMBER OF POSITIONS

生産対応可能極数については、営業部に
ご確認ください。
Feel free to contact our sales department
for available numbers of positions.

0.5mm Pitch
SERIES

6223

エンボス梱包品
Tape and Reel Package

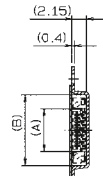
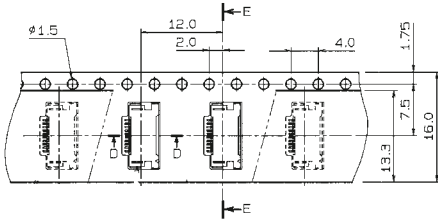

SECT. E-E

| 極数 NO. OF POS. | A | B |
|----------------------|-----|------|
| 5 | 3.2 | 7.3 |
| 6 | 3.7 | 7.8 |
| 7 | 4.2 | 8.3 |
| 8 | 4.7 | 8.8 |
| 9 | 5.2 | 9.3 |
| 10 | 5.7 | 9.8 |
| 11 | 6.2 | 10.3 |

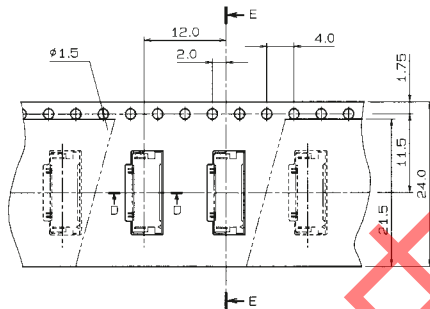

SECT. E-E

| 極数 NO. OF POS. | A | B |
|----------------------|------|------|
| 12 | 6.7 | 10.8 |
| 13 | 7.2 | 11.3 |
| 14 | 7.7 | 11.8 |
| 15 | 8.2 | 12.3 |
| 16 | 8.7 | 12.8 |
| 17 | 9.2 | 13.3 |
| 18 | 9.7 | 13.8 |
| 19 | 10.2 | 14.3 |
| 20 | 10.7 | 14.8 |
| 21 | 11.2 | 15.3 |
| 22 | 11.7 | 15.8 |
| 23 | 12.2 | 16.3 |
| 24 | 12.7 | 16.8 |
| 25 | 13.2 | 17.3 |
| 26 | 13.7 | 17.8 |
| 27 | 14.2 | 18.3 |

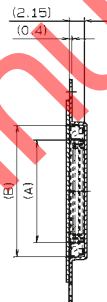
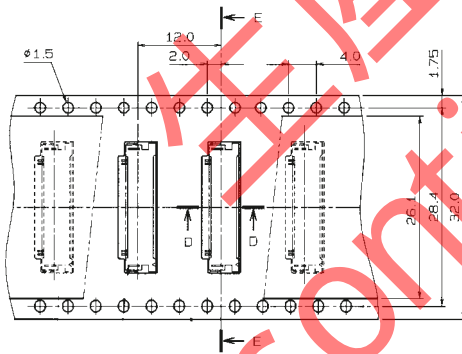

SECT. E-E

| 極数 NO. OF POS. | A | B |
|----------------------|------|------|
| 28 | 14.7 | 18.8 |
| 29 | 15.2 | 19.3 |
| 30 | 15.7 | 19.8 |

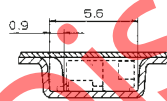

SECT. D-D

注文コード ORDERING CODE

08 6223 0XX 101 XXX+

RoHS 対応品

RoHS Compliant Product

800+ : スズ銅めっき Sn-Cu Plated

829+ : 金めっき Au Plated

極数 NUMBER OF POSITIONS

生産対応可能極数については、営業部にご確認願います。

Feel free to contact our sales department for available numbers of positions.

梱包数量 2000個/リール
PACKING QUANTITY : 2000/Reel