

Type BLR-I-506

Fuse Block - Indicating

6 Pole – Regular Auto Blade



www.optifuse.com

(619) 593-5050

Specifications:

- Voltage:** 32 VDC
- Max Current Rating:** 30A per Circuit - 100A Max Input
- Fuse Type:** Regular Auto Blade – APR / ANR
- Base:** PBT (UL flame: 94V-0), Black
- Cover:** PC (UL flame: 94V-2), Transparent
- Push Button:** POM (White)
- Terminals:** Copper, Tin plated
- Indicating LED – Red**
- Temperature Rating:** -20° C ~ +85° C

Mechanical Dimensions: Inches [mm]

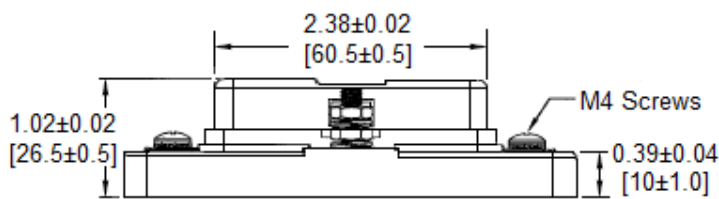
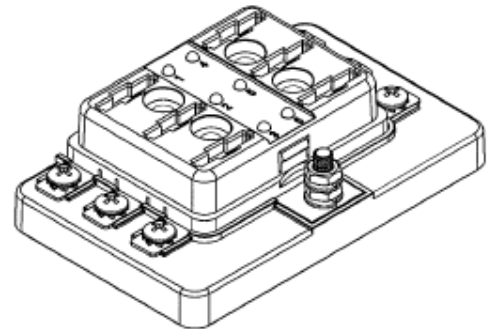
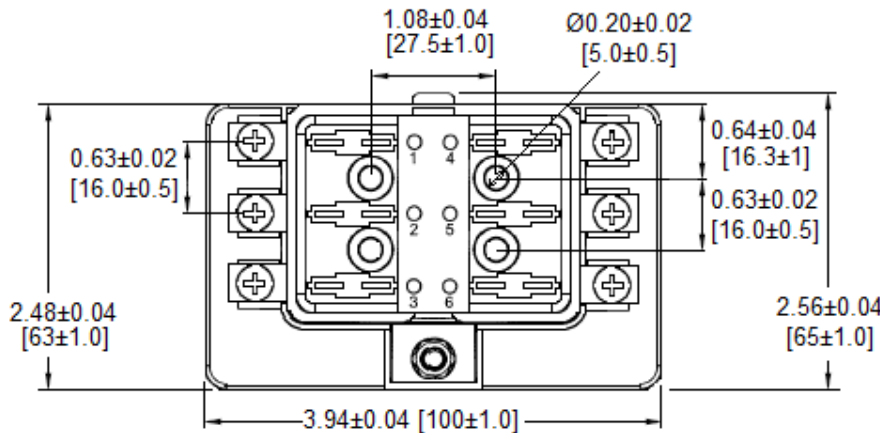

Connection Pad Option Available
Input wire size: #4-6 AWG
Output wire size: #12-16 AWG

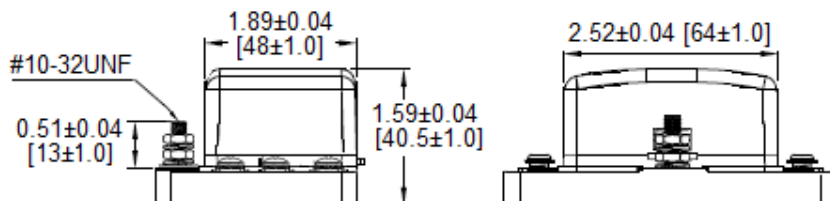

Mounting Holes	Terminal Dimensions

Warning:



-Operation beyond the specified maximum ratings or improper use may result in damage and possible electrical arcing and/or flame.

-Avoid contact of device with chemical solvent. Prolonged contact may damage the device performance.