

# LM62460RPHEVM EVM User's Guide



## ABSTRACT

The LM62460RPHEVM evaluation module (EVM) is designed to help customers evaluate the performance of the LM62460-Q1 synchronous step-down voltage converter. The EVM contains one LM62460-Q1 device in a 16-pin wettable flanks QFN (VQFN-HR) HotRod™ package. It is capable of delivering 5-V output voltage and up to 6-A load current with exceptional efficiency and output accuracy in a very small solution size. The EVM provides multiple power connectors, jumpers, resistors and capacitors to enable connection and configuration of output voltage, spread spectrum, mode setting options, and more for customer convenience. It also provides a good layout example which is optimized for EMI performance and passes CISPR 25 Class 5 standards. The layout is also optimized for thermal performance, operating with  $\Theta_{JA} = 21.6^{\circ}\text{C}/\text{W}$  on a 102 mm x 76 mm, 4-layer board with 2 oz / 1 oz / 1 oz / 2 oz copper thickness stack.

**Table 1-1. Device and Package Configurations**

CONVERTER	IC	PACKAGE
U1	LM62460-Q1	16-pin wettable flanks HotRod QFN (VQFN-HR) 3.5 mm × 4.5 mm × 0.9 mm



**Figure 1-1. LM62460RPHEVM Board Image**

## Table of Contents

<b>1 Introduction</b> .....	3
1.1 LM62460RPHEVM Synchronous Step-Down Voltage Converter.....	3
<b>2 Quick Start</b> .....	4
<b>3 Detailed Descriptions</b> .....	5
<b>4 Schematic</b> .....	6
<b>5 Board Layout</b> .....	7
<b>6 Board Curves</b> .....	11
<b>7 Bill of Materials</b> .....	14
<b>Revision History</b> .....	15

## List of Figures

Figure 1-1. LM62460RPHEVM Board Image.....	1
Figure 1-1. LM62460-Q1 Pin Configuration (16-Pin VQFN-HR Package Top View).....	3
Figure 4-1. LM62460RPHEVM Schematic.....	6
Figure 5-1. Top layer and top silkscreen.....	7
Figure 5-2. Top layer routing.....	8
Figure 5-3. Mid-layer 1 ground plane.....	8
Figure 5-4. Mid-layer 2 routing.....	9
Figure 5-5. Bottom layer routing.....	9
Figure 5-6. Bottom layer and bottom silkscreen.....	10
Figure 6-1. LM62460-Q1 5-V 2.2-MHz Efficiency in Auto Mode.....	11
Figure 6-2. LM62460-Q1 5-V 2.2-MHz Efficiency in FPWM Mode.....	11
Figure 6-3. LM62460-Q1 3.3-V 2.2-MHz Efficiency in Auto Mode.....	11
Figure 6-4. LM62460-Q1 3.3-V 2.2-MHz Efficiency in FPWM Mode.....	11
Figure 6-5. Conducted EMI versus CISPR25 Class 5 Limits (Green: Peak Signal, Blue: Average Signal).....	11
Figure 6-6. Radiated EMI Bicon Horizontal versus CISPR25 Class 5 Limits.....	11
Figure 6-7. Radiated EMI Bicon Vertical versus CISPR25 Class 5 Limits.....	12
Figure 6-8. Radiated EMI Log Horizontal versus CISPR25 Class 5 Limits.....	12
Figure 6-9. Radiated EMI Log Vertical versus CISPR25 Class 5 Limits.....	12
Figure 6-10. LM62460-Q1 EVM Thermal Performance with $V_{IN} = 12\text{ V}$ Providing $\Theta_{JA} = 21.6^\circ\text{C/W}$ .....	12

## List of Tables

Table 1-1. Device and Package Configurations.....	1
Table 6-1. BOM for Board Curves.....	13
Table 7-1. LM62460RPHEVM 6-A 2.2-MHz EVM Bill of Materials.....	14

## Trademarks

HotRod™ is a trademark of Texas Instruments.

All trademarks are the property of their respective owners.

# 1 Introduction

## 1.1 LM62460RPHEVM Synchronous Step-Down Voltage Converter

The LM62460-Q1 is an easy-to-use synchronous step-down DC-DC converter capable of driving up to 6 A of load current from a supply voltage ranging from 3 V to 36 V. The LM62460-Q1 provides exceptional efficiency and output accuracy in a very small solution size. The LM62460-Q1 implements peak-current-mode control. Additional features such as adjustable/synchronizable switching frequency, pin selectable dual-random spread spectrum (DRSS), true slew rate control, FPWM/AUTO selection, power-good/RESET flag, and precision enable provide both flexible and easy-to-use solutions for a wide range of applications. Automatic frequency foldback (AUTO mode) at light load and optional external bias improve efficiency over the entire load range. The device family requires few external components and has a pinout designed for simple PCB layout with excellent EMI and thermal performance. Protection features include thermal shutdown, input undervoltage lockout, cycle-by-cycle current limiting, and hiccup short-circuit protection. The LM62460-Q1 is pin-to-pin compatible with LM61480-Q1 (8-A converter) and LM61495-Q1 (10-A converter) for easy current scaling.

The pin configuration of the LM62460-Q1 is shown in [Figure 1-1](#).

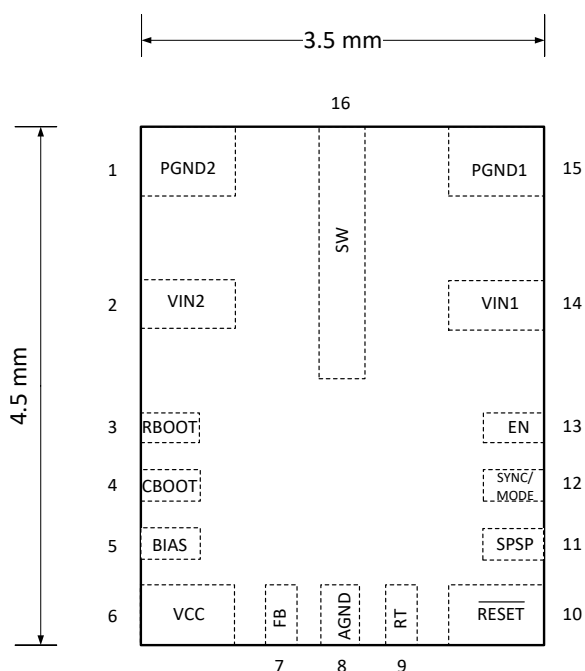

**Figure 1-1. LM62460-Q1 Pin Configuration (16-Pin VQFN-HR Package Top View)**

## 2 Quick Start

1. Connect the voltage supply between VIN\_EMI and GND\_EMI terminals using short, thick wires.
2. Connect the load of the converter between VOUT and GND (J2) terminals, using short, thick wires.
3. Set the supply voltage ( $V_{IN}$ ) at an appropriate level between 6 V to 36 V. Set the current limit of the supply to an appropriate level depending on the connected load.
4. Turn on the power supply. With the default configuration, the EVM should power up and provide  $V_{OUT} = 5$  V.
5. Monitor the output voltage. The maximum rated load current is 6 A.

### 3 Detailed Descriptions

This section describes the connectors and the test points on the EVM.

- VIN\_EMI (J1)** Input voltage to the converter connecting to  $V_{IN}$  of the converter through an EMI filter.
- VIN\_EMI terminal connects to the input capacitors and the VIN pins of the LM62460-Q1 through an input EMI filter. Connect the supply voltage (battery, bench-top supply, or other supply) between VIN\_EMI and GND\_EMI connectors. The voltage range should be higher than 3.5 V for the device to start up, and above 3V to continue operation.  $V_{IN}$  higher than 6 V provides regulated 5 V output voltage.  $V_{IN}$  should be no higher than 36 V to avoid damaging the device. The current limit on the supply must be high enough to provide the needed supply current, otherwise the supply voltage may not maintain the desired voltage. The supply voltage should be connected to the board with short, thick wires to handle the pulsing input current.
- GND\_EMI (J1)** Ground connection near the input filter.
- This is the current return path for the supply connected to VIN\_EMI.
- VOUT (J2)** Output voltage of the converter.
- VOUT terminal connects to the power inductor and the output capacitors. Connect the loading device between VOUT and GND connectors on J2 to load the converter output. Connect the loading device to the board with short, thick wires to handle the large DC output current.
- GND (J2)** Ground connection near the output.
- This is the current return path for the output voltage connected to VOUT.
- Input Filter** Prevents noise from contaminating supply voltage
- The input filter consists of a ferrite bead, filter inductor, and filter capacitors, located on the bottom side of the PCB. The output of the filter is connected to the  $V_{IN}$  net, which is connected to the VIN pins of the LM62460-Q1 and the input capacitors.
- Conducted EMI arises from the normal operation of switching circuits. The ON and OFF actions of the power switches generate large discontinuous currents. The discontinuous currents are present at the input side of buck converters. Voltage ripple generated by discontinuous currents can be conducted to the voltage supply of the buck converter via physical contact of the conductors. Without control, excessive input voltage ripple can compromise operation of other devices connected to the source. The input filter helps to smooth out the voltage perturbations leading to the source.
- VIN\_S** Test point to monitor the input voltage of the device.
- PGND** Test point for GND reference when measuring VIN\_S.
- VOUT\_S** Test point to monitor the output voltage of the device.
- PGND3** Test point for GND reference when measuring VOUT\_S.
- FB** Test point for measuring the voltage on the FB pin of the device.
- AGND** Test point for AGND reference when measuring FB.
- RT** Test point for measuring the voltage on the RT pin of the device.
- RESET** Test point for measuring the voltage on the RESET (power good) pin of the device.
- VCC** Test point for measuring the voltage on the VCC pin of the device.
- SYNC/MODE** Test point for measuring the voltage on the SYNC/MODE pin of the device or to apply a synchronizing clock signal.
- PGND2** Additional GND reference point for test point measurements.
- FB jumper (J4)** Place the shunt connecting FB and 5V to set  $V_{OUT} = 5V$ . Place the shunt connecting FB and 3.3V to set  $V_{OUT} = 3.3V$ .

## 4 Schematic

The LM62460RPHEVM schematic is shown in Figure 4-1.

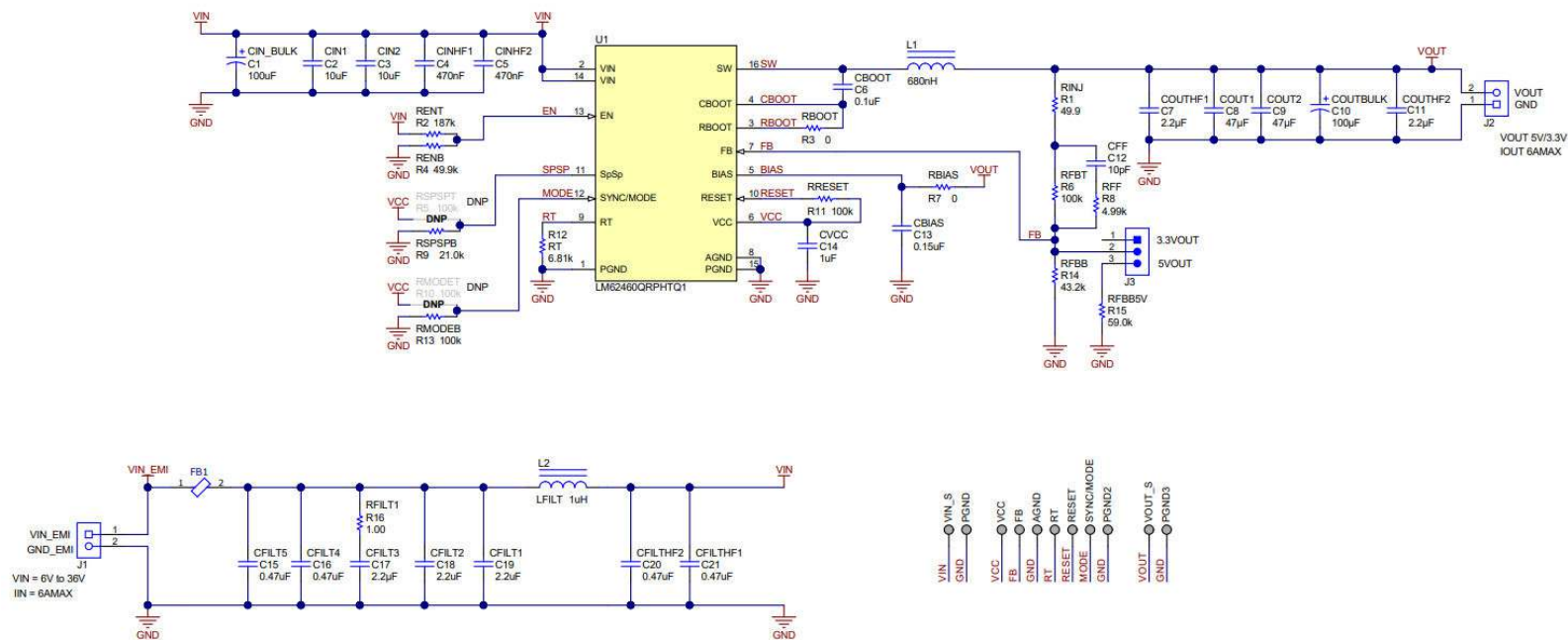

Figure 4-1. LM62460RPHEVM Schematic

## 5 Board Layout

Figure 5-1 through Figure 5-6 show the board layout for the LM62460RPHEVM. The EVM offers resistors, capacitors, test points, and a jumper to configure the output voltage and precision enable pin, and set frequency and external clock synchronization among the other features of the LM62460-Q1.

The PCB is optimized for thermal performance. The board contains 4 layers. There are 2-oz copper layers on the top and bottom and 1-oz copper mid-layers. The LM62460-Q1 does not have a thermal pad so the best path to move the heat out of the IC is through the pins and into the board. The PGND pins connect to the large GND plane which spreads the heat to the rest of the board. The GND plane also has thermal vias to spread the heat more efficiently to other layers for additional improved thermal performance.

The PCB is also optimized for EMI performance. The layout minimizes the area of high dv/dt nodes like SW and BOOT. The small high-frequency ceramic input capacitors are placed very close to the IC to minimize the loop formed from VIN pins, through the capacitor, to the PGND pins. The board also features an EMI filter on the back-side of the board with options for an inductor, ferrite bead, and filter capacitors to tune the desired EMI performance. The full filter may not be necessary to pass particular EMI requirements but the components and pads are available for flexibility.

The screw terminals J1 and J2 allow for high-current connections to the board. Jumper J3 allows the user to select the output voltage, 5V or 3.3V. Pin voltages can be probed using the test points. The rest of the features can be adjusted by modifying the appropriate resistor values.

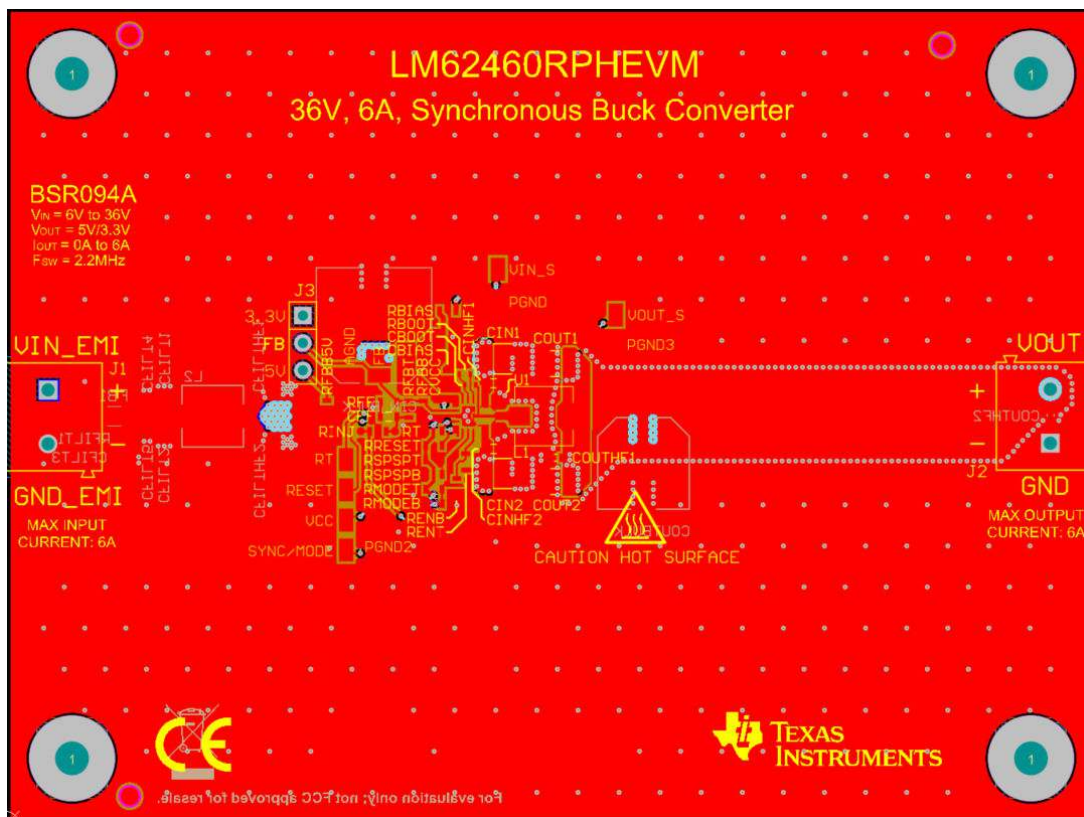

Figure 5-1. Top layer and top silkscreen

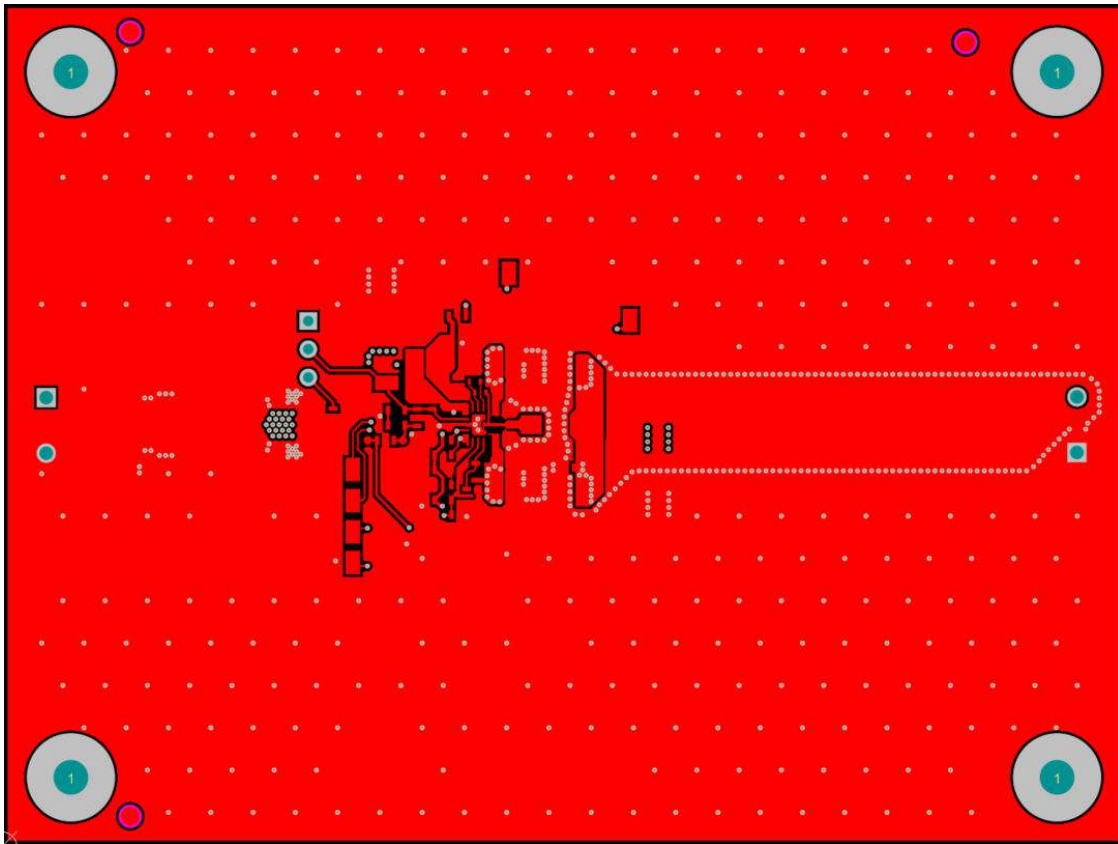

Figure 5-2. Top layer routing

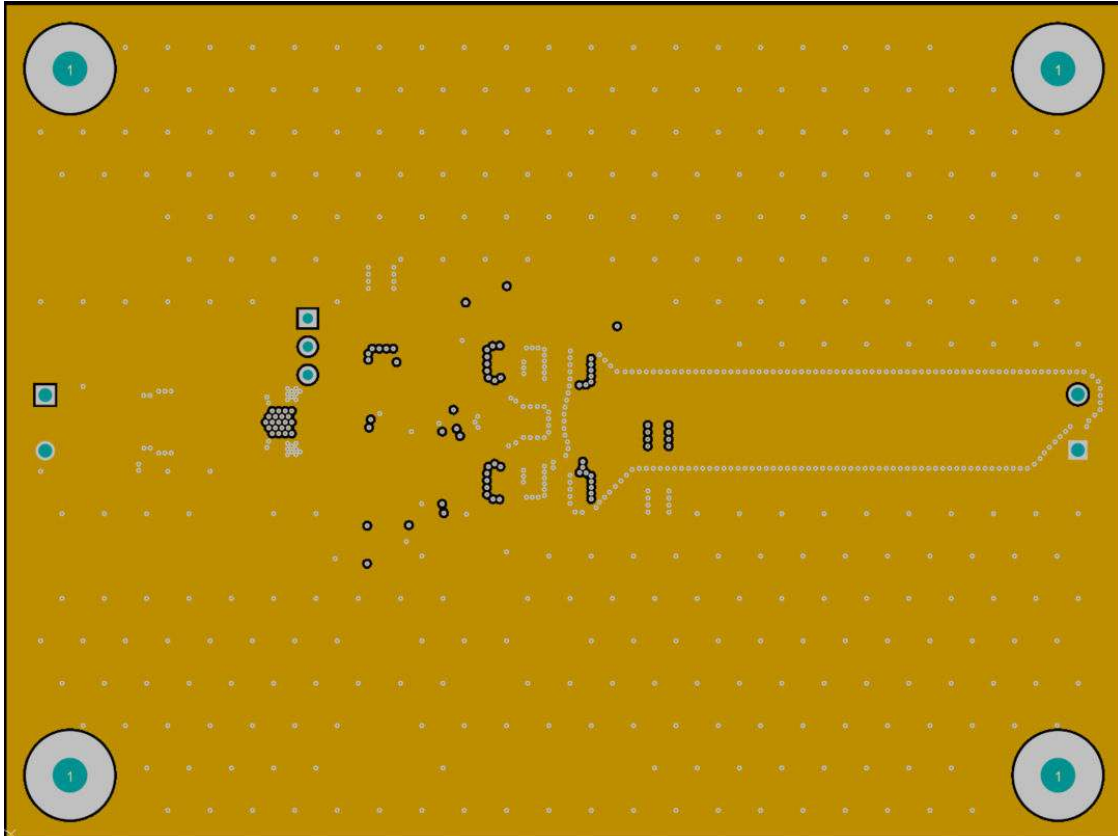

Figure 5-3. Mid-layer 1 ground plane



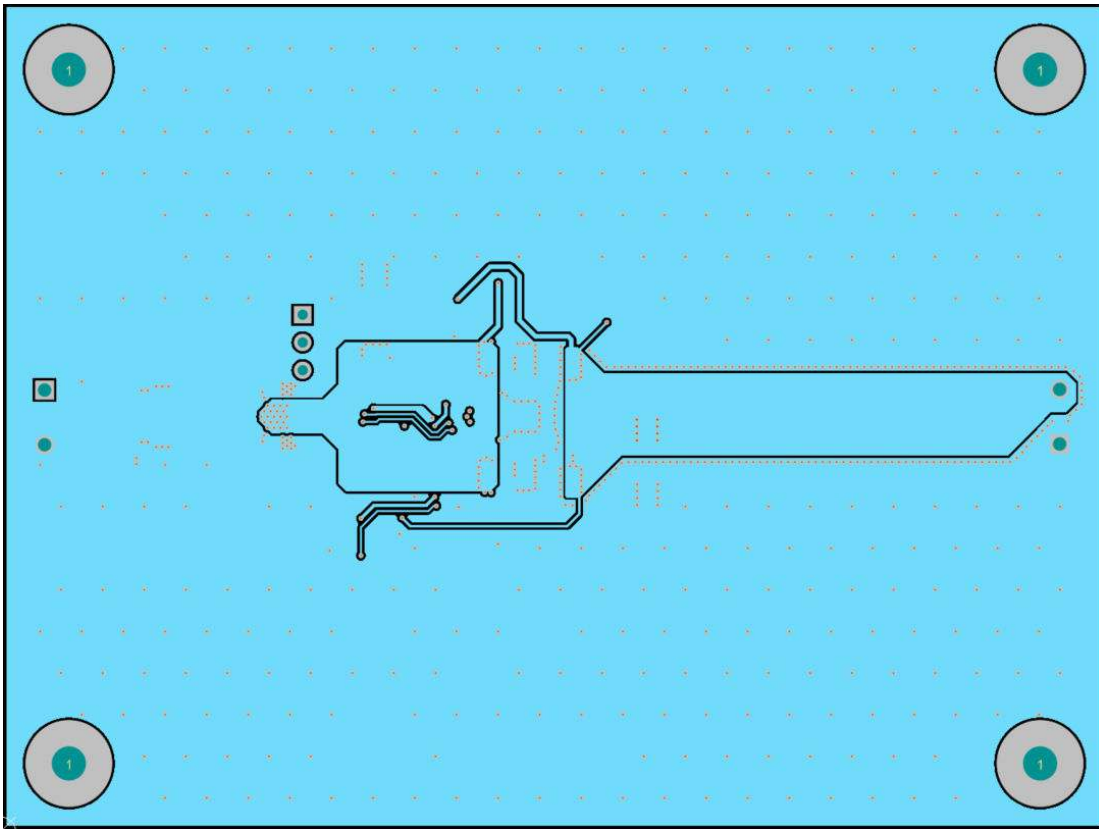

Figure 5-4. Mid-layer 2 routing

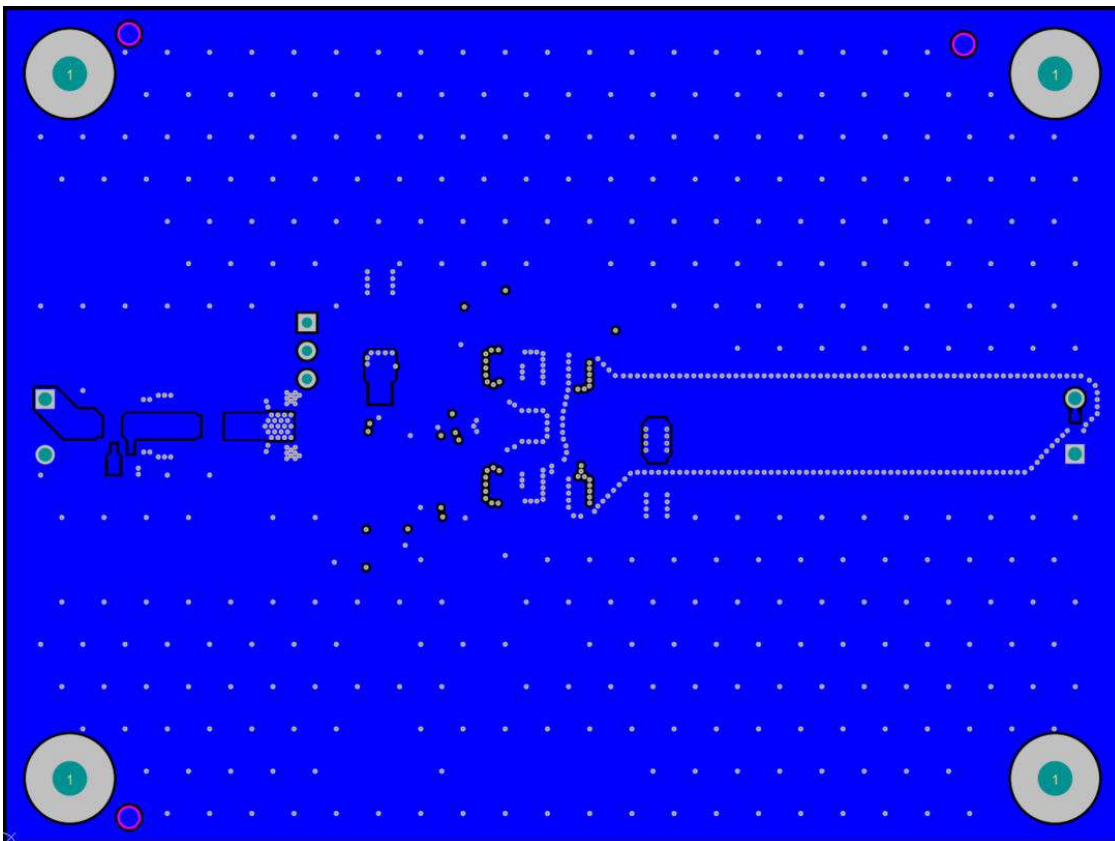

Figure 5-5. Bottom layer routing

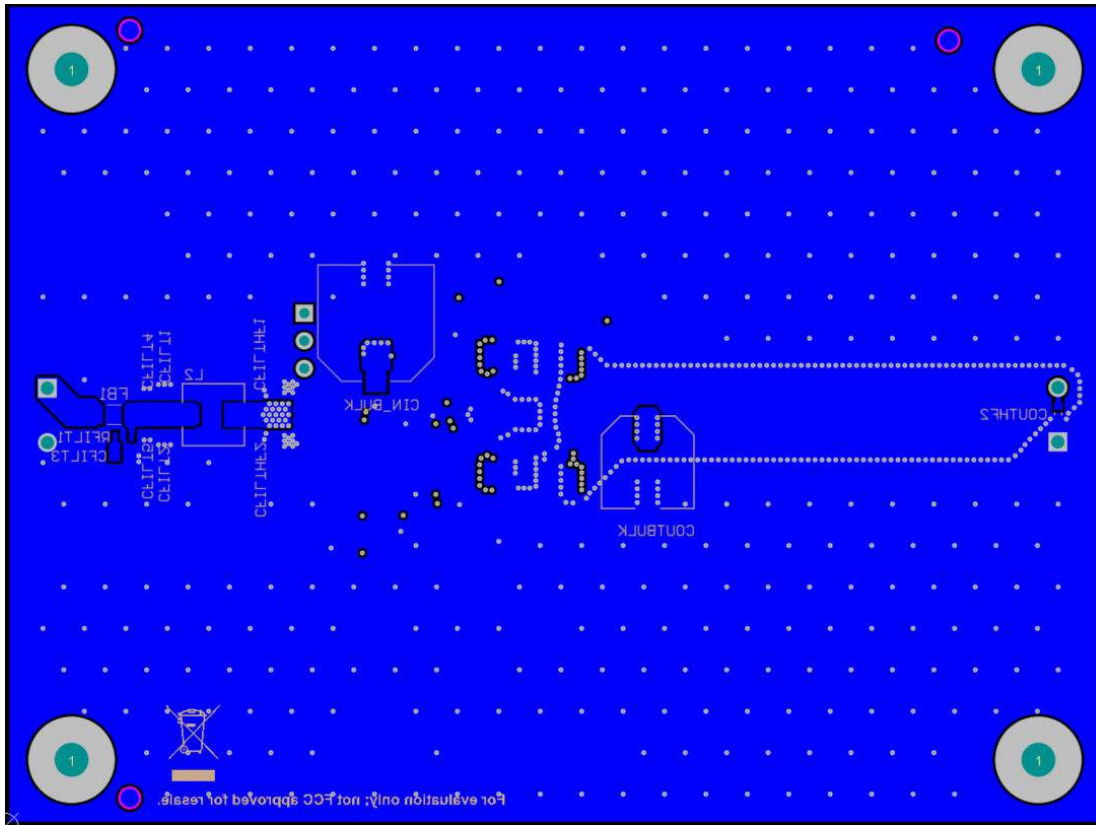

Figure 5-6. Bottom layer and bottom silkscreen

## 6 Board Curves

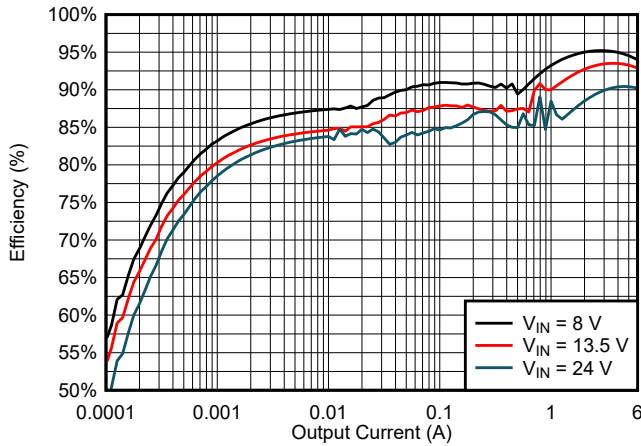

Figure 6-1. LM62460-Q1 5-V 2.2-MHz Efficiency in Auto Mode

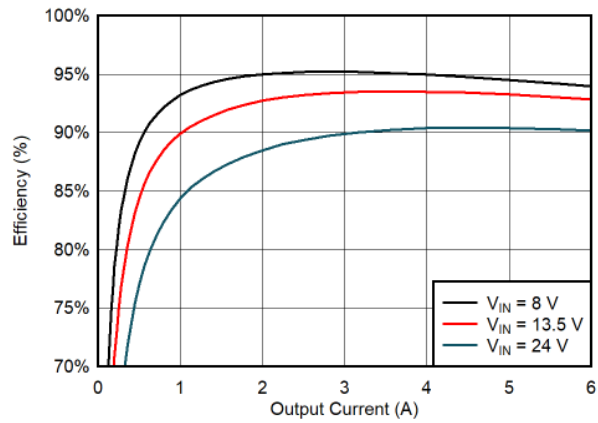

Figure 6-2. LM62460-Q1 5-V 2.2-MHz Efficiency in FPWM Mode

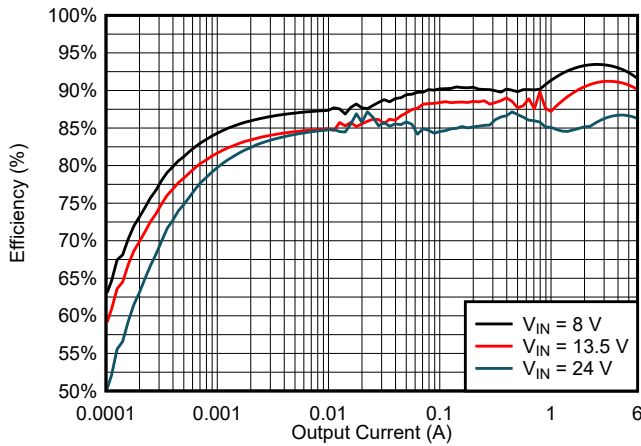

Figure 6-3. LM62460-Q1 3.3-V 2.2-MHz Efficiency in Auto Mode

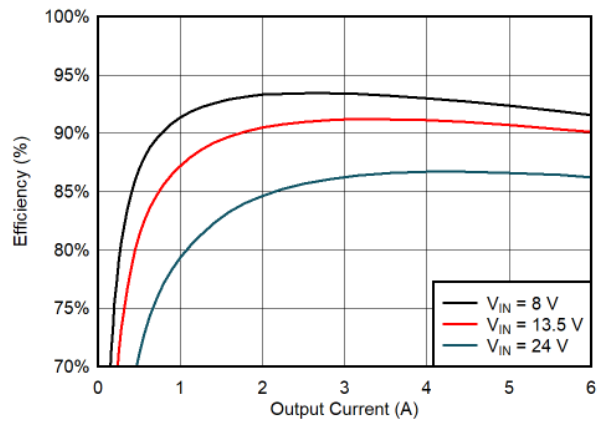
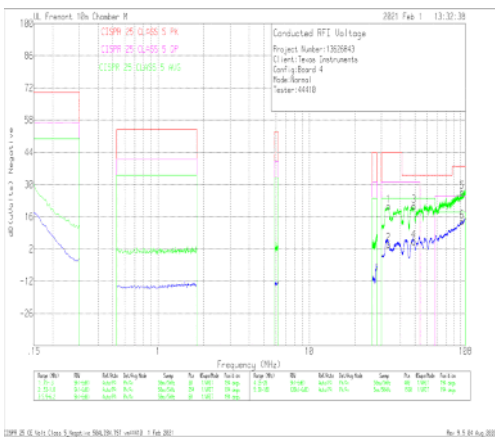
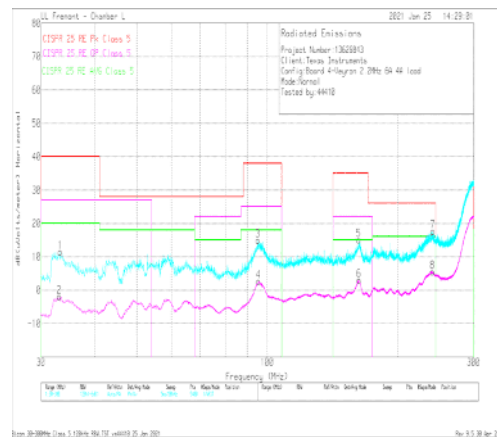

Figure 6-4. LM62460-Q1 3.3-V 2.2-MHz Efficiency in FPWM Mode



$V_{OUT} = 5\text{ V}$   $F_{SW} = 2.2\text{ MHz}$   $I_{OUT} = 4\text{ A}$   
Frequency Tested: 0.15 MHz to 108 MHz

Figure 6-5. Conducted EMI versus CISPR25 Class 5 Limits (Green: Peak Signal, Blue: Average Signal)



$V_{OUT} = 5\text{ V}$   $F_{SW} = 2.2\text{ MHz}$   $I_{OUT} = 4\text{ A}$   
Frequency Tested: 30 MHz to 300 MHz

Figure 6-6. Radiated EMI Bicon Horizontal versus CISPR25 Class 5 Limits

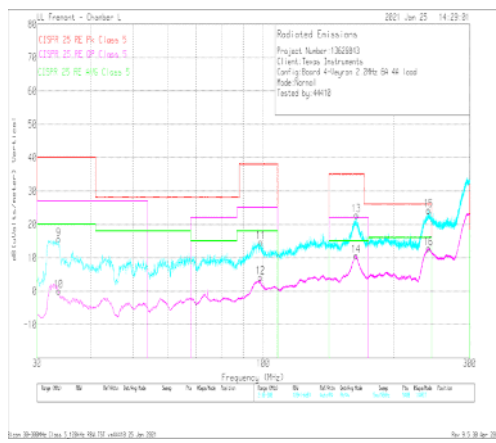

$V_{OUT} = 5\text{ V}$        $F_{SW} = 2.2\text{ MHz}$        $I_{OUT} = 4\text{ A}$   
Frequency Tested: 30 MHz to 300 MHz

**Figure 6-7. Radiated EMI Bicon Vertical versus CISPR25 Class 5 Limits**

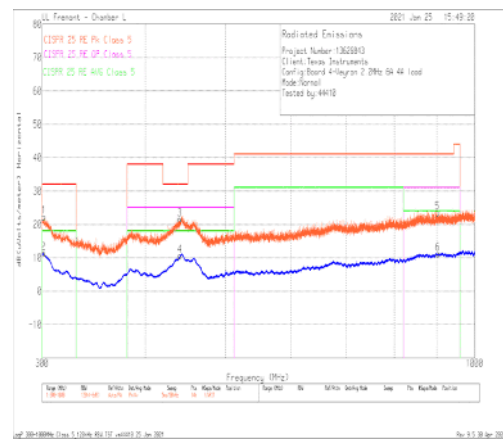

$V_{OUT} = 5\text{ V}$        $F_{SW} = 2.2\text{ MHz}$        $I_{OUT} = 4\text{ A}$   
Frequency Tested: 300 MHz to 1 GHz

**Figure 6-8. Radiated EMI Log Horizontal versus CISPR25 Class 5 Limits**

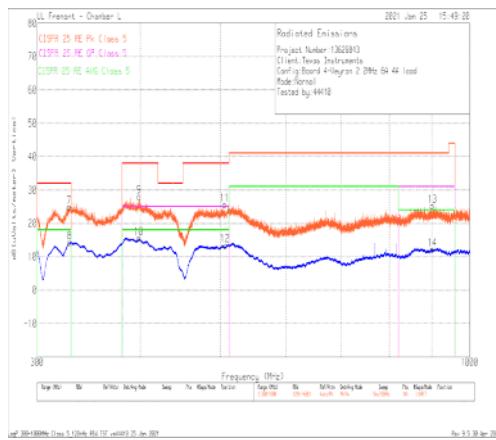

$V_{OUT} = 5\text{ V}$        $F_{SW} = 2.2\text{ MHz}$        $I_{OUT} = 4\text{ A}$   
Frequency Tested: 300 MHz to 1 GHz

**Figure 6-9. Radiated EMI Log Vertical versus CISPR25 Class 5 Limits**

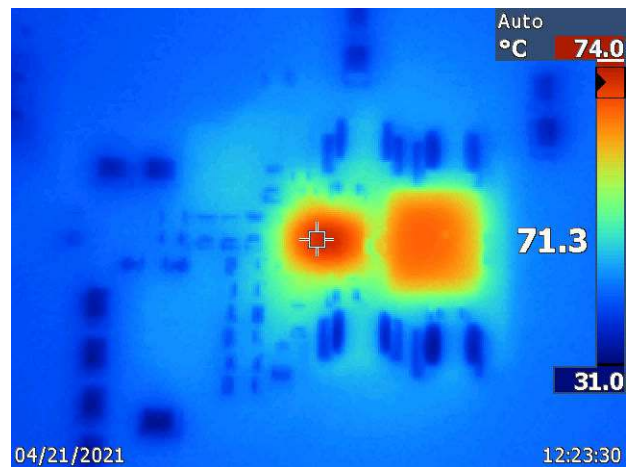

$V_{OUT} = 5\text{ V}$        $F_{SW} = 2.2\text{ MHz}$        $I_{OUT} = 6\text{ A}$

**Figure 6-10. LM62460-Q1 EVM Thermal Performance with  $V_{IN} = 12\text{ V}$  Providing  $\Theta_{JA} = 21.6^\circ\text{C/W}$**

**Table 6-1. BOM for Board Curves**

V <sub>OUT</sub>	FREQUENCY	R <sub>FBB</sub>	C <sub>OUT</sub>	C <sub>IN</sub> + C <sub>HF</sub>	L
3.3 V	2200 kHz	43.2 kΩ	2 x 47 μF + 100 μF electrolytic + 2 x 2.2 μF	2 x 10 μF + 2 x 470 nF + 100 μF electrolytic	0.68 μH (744373460068)
5 V	2200 kHz	24.9 kΩ	2 x 47 μF + 100 μF electrolytic + 2 x 2.2 μF	2 x 10 μF + 2 x 470 nF + 100 μF electrolytic	0.68 μH (744373460068)

## 7 Bill of Materials

The bills of materials of the LM62460RPHEVM is shown in [Table 7-1](#).

**Table 7-1. LM62460RPHEVM 6-A 2.2-MHz EVM Bill of Materials**

DESIGNATOR	DESCRIPTION	MANUFACTURER	PART NUMBER	QUANTITY
AGND, FB, PGND, PGND2, PGND3, RESET, RT, SYNC/MODE, VCC, VIN_S, VOUT_S	Test Point, SMT	Harwin	S2751-46R	11
C1	CAP, AL, 100 uF, 63 V, +/- 20%, 0.35 ohm, AEC-Q200 Grade 2, SMD	Panasonic	EEE-FK1J101P	1
C2, C3	CAP, CERM, 10 uF, 50 V, +/- 10%, X5R, 1210	TDK	C3225X5R1H106K250AB	2
C4, C5	CAP, CERM, 0.47 uF, 50 V, +/- 10%, X7R, AEC-Q200 Grade 1, 0603	TDK	CGA3E3X7R1H474K080AB	2
C6	CAP, CERM, 0.1 uF, 50 V, +/- 10%, X7R, AEC-Q200 Grade 1, 0402	TDK	CGA2B3X7R1H104K050BB	1
C7, C11	CAP, CERM, 2.2 uF, 10 V, +/- 10%, X7R, AEC-Q200 Grade 1, 0603	MuRata	GRM188R71A225KE15J	2
C8, C9	CAP, CERM, 47 uF, 10 V, +/- 10%, X7S, AEC-Q200 Grade 1, 1210	MuRata	GCM32EC71A476KE02K	2
C10	CAP, AL, 100 uF, 16 V, +/- 20%, AEC-Q200 Grade 3, SMD	Panasonic	EEE-1CA101AP	1
C12	CAP, CERM, 10 pF, 50 V, +/- 5%, C0G/NP0, AEC-Q200 Grade 1, 0603	TDK	CGA3E2C0G1H100D080AA	1
C13	CAP, CERM, 0.15 uF, 50 V, +/- 10%, X7R, AEC-Q200 Grade 1, 0603	TDK	CGA3E3X7R1H154K080AB	1
C14	CAP, CERM, 1 uF, 16 V, +/- 20%, X7R, AEC-Q200 Grade 1, 0603	MuRata	GCM188R71C105MA64D	1
C15, C16, C20, C21	CAP, CERM, 0.47 uF, 50 V, +/- 10%, X7R, AEC-Q200 Grade 1, 0603	TDK	CGA3E3X7R1H474K080AE	4
C17, C18, C19	CAP, CERM, 2.2 uF, 50 V, +/- 10%, X7R, AEC-Q200 Grade 1, 0805	TDK	CGA4J3X7R1H225K125AB	3
FB1	Chip Ferrite Bead, 1206, 120Ω @ 100MHz, 0.009Ω, 25%, 6A	Murata	BLM31KN121SZ1L	1
H1, H2, H3, H4	Machine Screw, Round, #4-40 x 1/4, Nylon, Philips panhead	B&F Fastener Supply	NY PMS 440 0025 PH	4
H5, H6, H7, H8	Standoff, Hex, 0.5"L #4-40 Nylon	Keystone	1902C	4
J1, J2	Terminal Block, 5 mm, 2x1, Tin, TH	Würth Elektronik	691 101 710 002	2
J3	Header, 100mil, 3x1, Gold, TH	Sullins Connector Solutions	PBC03SAAN	1
L1	680nH Shielded Molded Inductor 8A 12mOhm Max 2-SMD	Würth Electronics	744373360068	1
L2	Inductor, Wirewound, 1 uH, 7.3 A, 0.013 ohm, SMD	Würth Elektronik	74437336010	1
R1	RES, 49.9, 1%, 0.1 W, AEC-Q200 Grade 0, 0603	Vishay-Dale	CRCW060349R9FKEA	1
R2	RES, 187 k, 1%, 0.1 W, 0603	Yageo	RC0603FR-07187KL	1
R3	RES, 0, 5%, 0.063 W, AEC-Q200 Grade 0, 0402	Vishay-Dale	CRCW04020000Z0ED	1
R4	RES, 49.9 k, 1%, 0.1 W, AEC-Q200 Grade 0, 0603	Vishay-Dale	CRCW060349K9FKEA	1
R6, R11, R13	RES, 100 k, 1%, 0.1 W, AEC-Q200 Grade 0, 0603	Vishay-Dale	CRCW0603100KFKEA	3
R7	RES, 0, 1%, 0.1 W, AEC-Q200 Grade 0, 0603	Stackpole Electronics Inc	RMCF0603ZTOR00	1
R8	RES, 4.99 k, 1%, 0.1 W, AEC-Q200 Grade 0, 0603	Vishay-Dale	CRCW06034K99FKEA	1
R9	RES, 21.0 k, 1%, 0.1 W, AEC-Q200 Grade 0, 0603	Vishay-Dale	CRCW060321K0FKEA	1
R12	RES, 6.81 k, 1%, 0.1 W, AEC-Q200 Grade 0, 0603	Vishay-Dale	CRCW06036K81FKEA	1
R14	RES, 43.2 k, 1%, 0.1 W, AEC-Q200 Grade 0, 0603	Vishay-Dale	CRCW060343K2FKEA	1
R15	RES, 59.0 k, 1%, 0.1 W, AEC-Q200 Grade 0, 0603	Vishay-Dale	CRCW060359K0FKEA	1
R16	RES, 1.00, 1%, 0.1 W, AEC-Q200 Grade 0, 0603	Vishay-Dale	CRCW06031R00FKEA	1
SH-J3	Shunt, 100mil, Gold plated, Black	Samtec	SNT-100-BK-G	1
U1	LM62460QRPHTQ1, RPH0016A (VQFN-HR-16)	Texas Instruments	LM62460QRPHTQ1	1

## Revision History

NOTE: Page numbers for previous revisions may differ from page numbers in the current version.

DATE	REVISION	NOTES
April 2021	*	Initial release

## IMPORTANT NOTICE AND DISCLAIMER

TI PROVIDES TECHNICAL AND RELIABILITY DATA (INCLUDING DATA SHEETS), DESIGN RESOURCES (INCLUDING REFERENCE DESIGNS), APPLICATION OR OTHER DESIGN ADVICE, WEB TOOLS, SAFETY INFORMATION, AND OTHER RESOURCES "AS IS" AND WITH ALL FAULTS, AND DISCLAIMS ALL WARRANTIES, EXPRESS AND IMPLIED, INCLUDING WITHOUT LIMITATION ANY IMPLIED WARRANTIES OF MERCHANTABILITY, FITNESS FOR A PARTICULAR PURPOSE OR NON-INFRINGEMENT OF THIRD PARTY INTELLECTUAL PROPERTY RIGHTS.

These resources are intended for skilled developers designing with TI products. You are solely responsible for (1) selecting the appropriate TI products for your application, (2) designing, validating and testing your application, and (3) ensuring your application meets applicable standards, and any other safety, security, regulatory or other requirements.

These resources are subject to change without notice. TI grants you permission to use these resources only for development of an application that uses the TI products described in the resource. Other reproduction and display of these resources is prohibited. No license is granted to any other TI intellectual property right or to any third party intellectual property right. TI disclaims responsibility for, and you will fully indemnify TI and its representatives against, any claims, damages, costs, losses, and liabilities arising out of your use of these resources.

TI's products are provided subject to [TI's Terms of Sale](#) or other applicable terms available either on [ti.com](#) or provided in conjunction with such TI products. TI's provision of these resources does not expand or otherwise alter TI's applicable warranties or warranty disclaimers for TI products.

TI objects to and rejects any additional or different terms you may have proposed.

Mailing Address: Texas Instruments, Post Office Box 655303, Dallas, Texas 75265  
Copyright © 2022, Texas Instruments Incorporated