



# SUNON

## SPECIFICATION FOR APPROVAL

**CUSTOMER** :  
**DESCRIPTION** : DC BRUSHLESS FAN  
**DIMENSIONS** : 40X40X10 mm  
**MODEL** : KDE0504PFB1  
**P/N** : MS.M  
**APPROVED NO** :  
**APPROVED BY** :  
 (AUTHORIZED)



DAWN.	<i>Yuchen 8/9</i>	CHKD.	<i>[Signature]</i>	APPD.	<i>[Signature]</i>	SPEC.NO	M400601
						ISSUE DATE	08.09.2001
						EDITION	0
						REVISE DATE	
						E.SPEC	EM40203

建準電機工業股份有限公司  
 SUNONWEALTH ELECTRIC MACHINE INDUSTRY CO., LTD.  
 12FL., 120 CHUNG CHENG 1ST RD., TEL:886-7-7163069(41 LINES)  
 KAOHSIUNG, TAIWAN, R. O. C. ~ FAX:886-7-7163086~89

DC BRUSHLESS FAN

MODEL: KDE0504PFB1

P/N : MS.M

**CHARACTERISTICS**

- 1. Motor Design : Patented single-coil DC brushless 4 poles motor Design.
- 2. Insulation Resistance : More than 500M ohm between internal stator and lead wire(+) measured by DC 500V.
- 3. Dielectric Strength : Applied AC 500V for one minute or AC 600V for 2 seconds between housing and lead wire(+)
- 4. Noise Level : Measured in a semi-anechoic chamber with background noise level below 15 dB(A). The fan is running in free air with Microphone at a distance of one meter from the fan intake.
- 5. Input power, Current & Speed : Measured after continuous 30 minutes Operation at rated voltage in clean air at ambient temperature of 25 degrees C.
- 6. Tolerances :  $\pm 15\%$  on rated power and current.
- 7. Motor Protection : Locked rotor protected.
- 8. Air Performance : Measured by a double chamber. The value are recorded when the fan speed is stabilized at rated voltage.

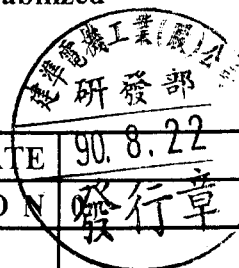
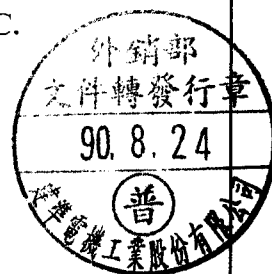

建準電機工業股份有限公司 SUNONWEALTH ELECTRIC MACHINE INDUSTRY CO., LTD.	SPEC.NO	M400601	REVISE DATE	90.8.22
	ISSUE DATE	08.09.2001	EDITION	發行章
	PAGE	2 OF 8		

**SPECIFICATIONS**

**MODEL: KDE0504PFB1**

**P/N : MS.M**

- 1-1. Rated Voltage : 5 VDC
- 1-2. Operating Voltage Range : 3-6 VDC
- 1-3. Starting Voltage : 3 VDC
- 1-4. Rated Speed : 7400 RPM ± 1000 RPM
- 1-5. Air Delivery : 7.3 CFM
- 1-6. Static Pressure : 0.18 Inch-H<sub>2</sub>O
- 1-7. Rated Current : 0.16 AMP
- 1-8. Rated Power : 0.8 WATTS
- 1-9. Noise Level : 31 dB(A)
- 1-10. Direction of Rotation : Counter-clockwise viewed front fan blade
- 1-11. Operating Temperature : -10 to +70 Deg.C
- 1-12. Storage Temperature : -40 to +70 Deg.C
- 1-13. Bearing System : Precise ball bearing system
- 1-14. Weight : 16g
- 1-15. Safety : UL/CUR/TUV/CE Approvals
- 1-16. Vibration : Vibration of acceleration 1.5G and Frequency 5~50~5Hz is applied in the 3 directions(X,Y,Z) for 30 minutes, each Direction at the cycle of 1 minute.

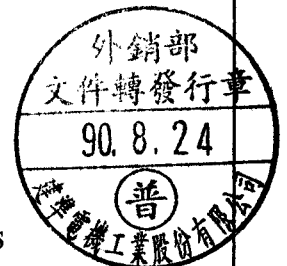

建準電機工業股份有限公司  
SUNONWEALTH ELECTRIC  
MACHINE INDUSTRY CO., LTD.

SPEC.NO	M400601	REVISE DATE	90.8.22
ISSUE DATE	08.09.2001	EDITION	發行章
PAGE	3 OF 8		

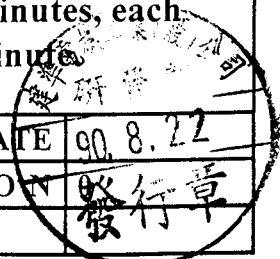

MODEL : KDE0504PFB1

P/N : MS.M

PERFORMANCE CURVES

STATIC  
PRESSURE

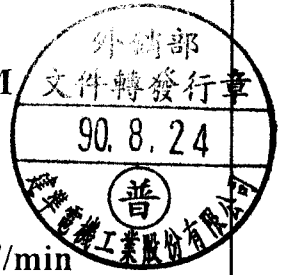
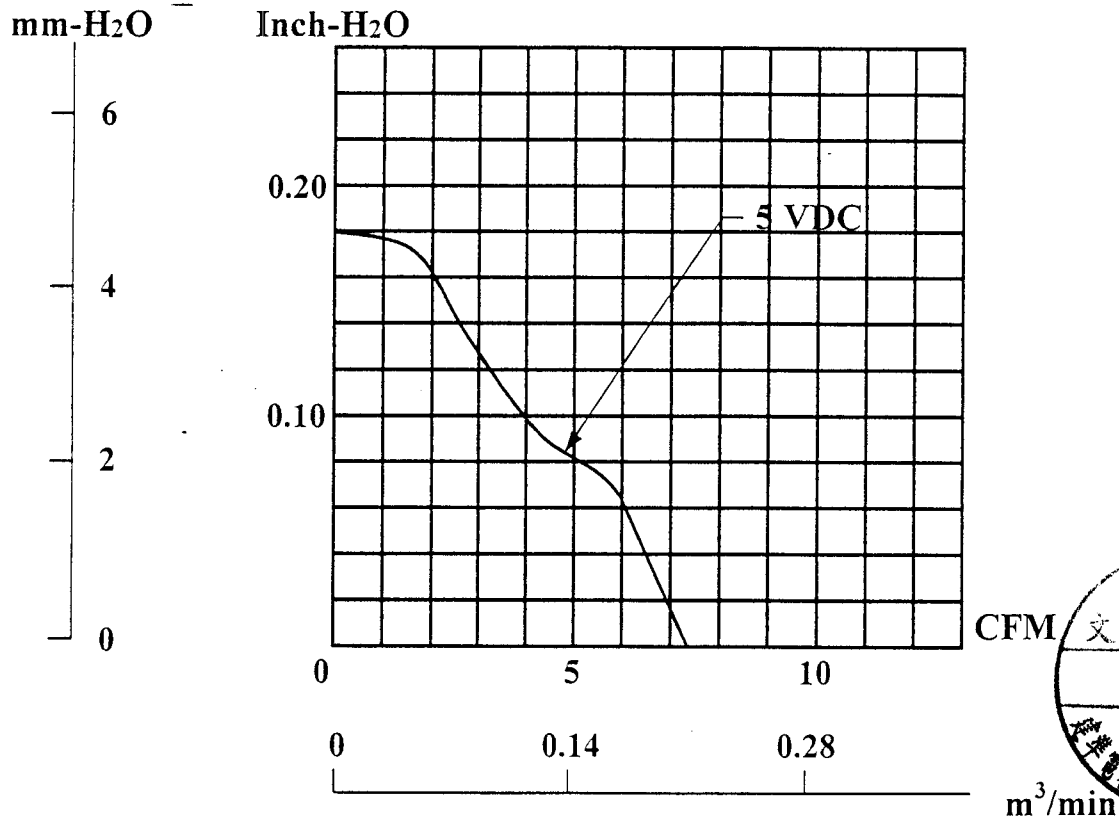

建準電機工業股份有限公司  
SUNONWEALTH ELECTRIC  
MACHINE INDUSTRY CO., LTD.

SPEC.NO	M400601	REVISE DATE	90.8.22
ISSUE DATE	08.09.2001	E D I T I O N	發行章
P A G E	4 OF 8		

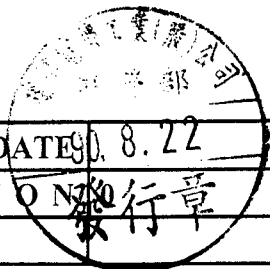

**MATERIAL**

- 2-1. Frame : Thermoplastic PBT of UL 94V-0
- 2-2. Impeller : Thermoplastic PBT of UL 94V-0
- 2-3. Bobbin : Thermoplastic PBT of UL 94V-0
- 2-4. Lead Wire : UL2468,26AWG,+RED;-BLACK  
UL1007,26AWG,YELLOW:3rd Wire

**DIMENSIONS**

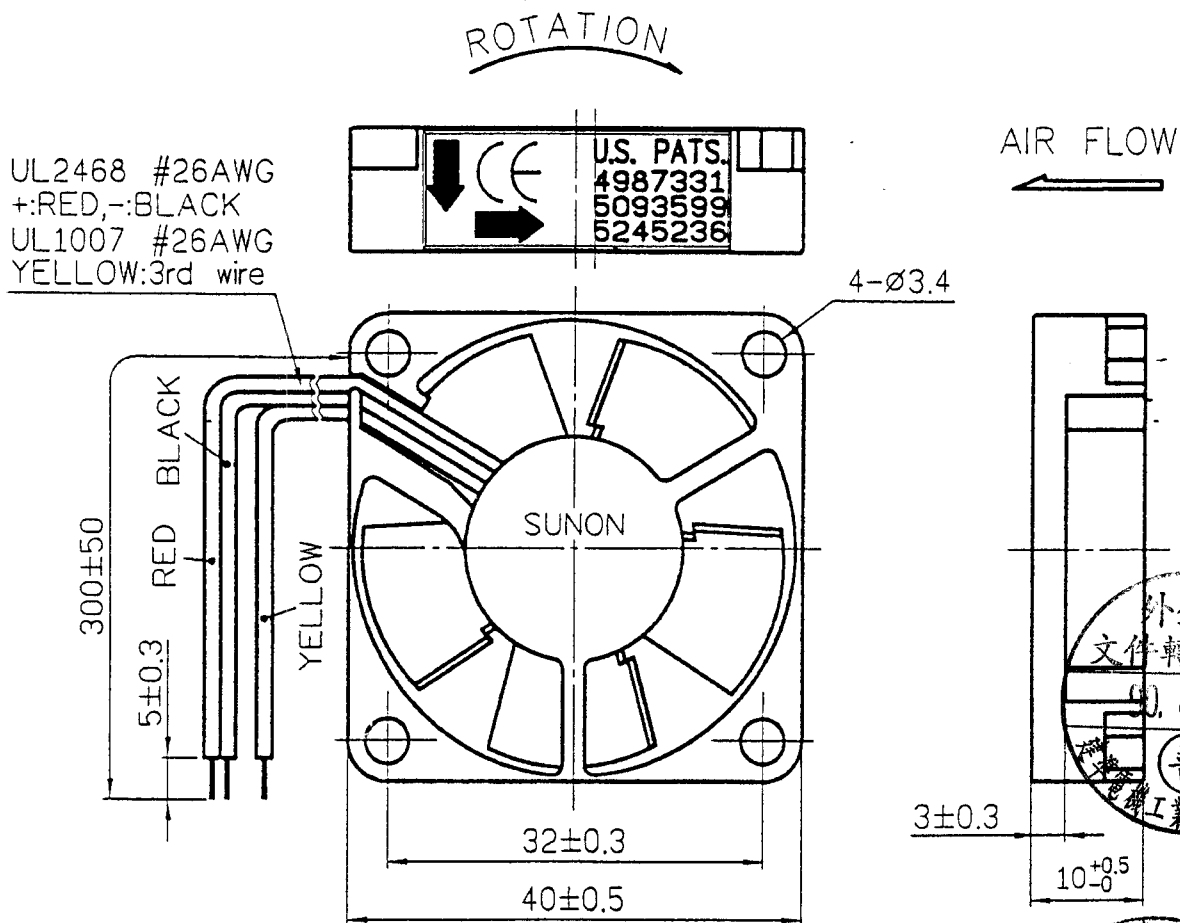

1. Air Flow Direction: Label side.
2. The Best Mounting Direction: In any orientation.

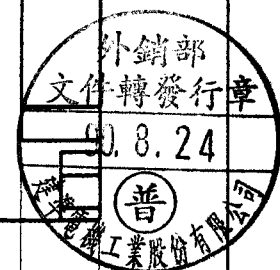

建準電機工業股份有限公司  
SUNONWEALTH ELECTRIC  
MACHINE INDUSTRY CO., LTD.

SPEC.NO	M400601	REVISE DATE	
ISSUE DATE	08.09.2001	EDITION	0
PAGE	5 OF 8		

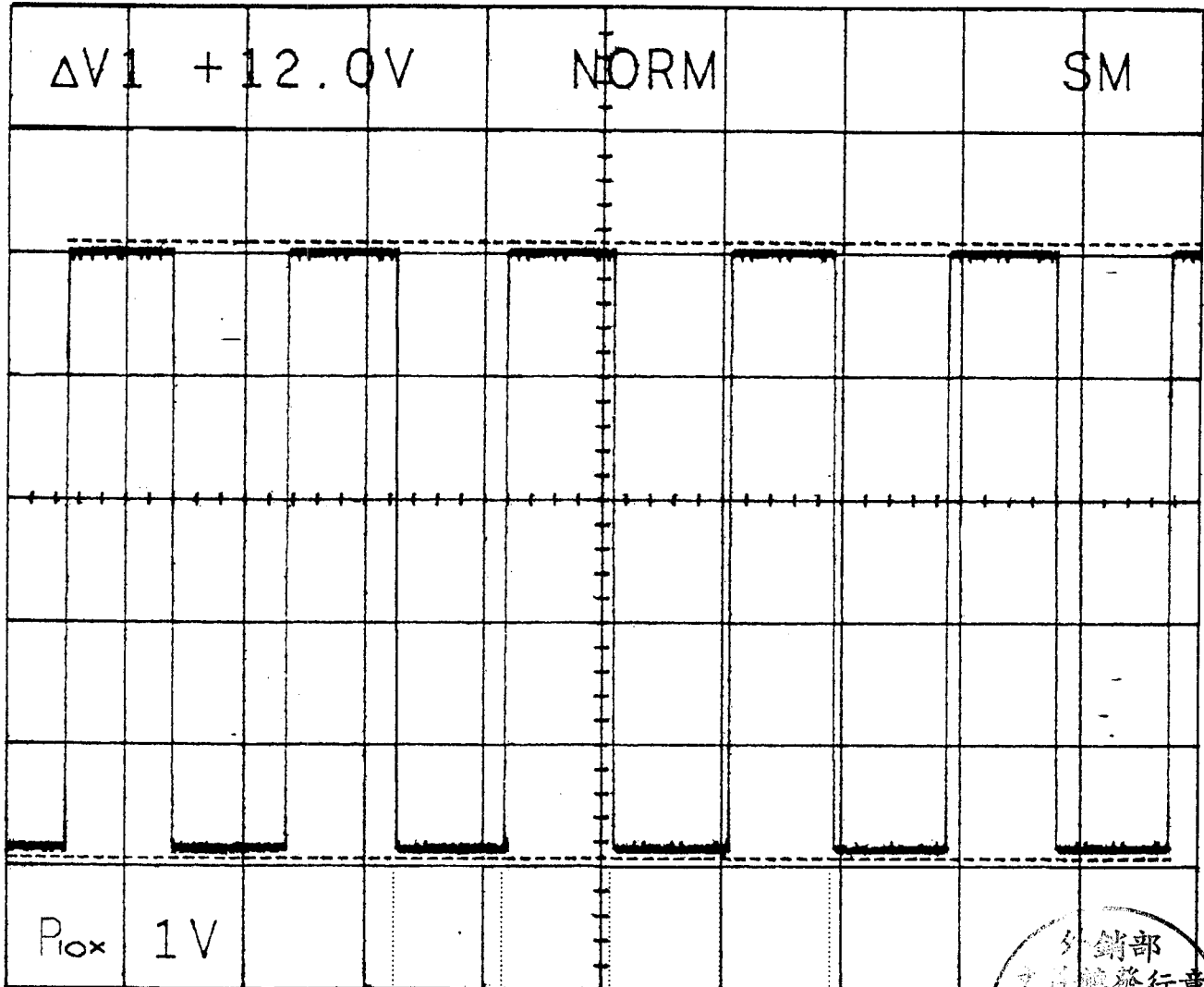

$T_1$     $T_2$     $T_3$     $T_4$   
 $T=1$  Rotation

$$T = T_1 + T_2 + T_3 + T_4 = (1 \text{ Rotation})$$

$$T_1 = T_2 = T_3 = T_4 = \frac{60}{4 \times \text{rpm}}$$

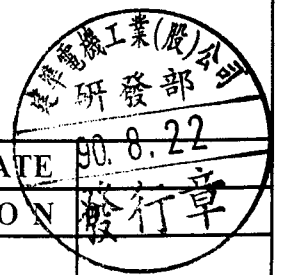

**FAN 3rd WIRE SIGNAL**

Fan with switching driving circuit designed for rpm measurement:  
 These fan motors have three lead wires:( +:Red,-:Black,output signal for 3rd wire:Yellow)

- M Type
  - ◆Low voltage start-up
  - ◆3rd wire square wave signal was amplified by a transistor (open collector type)

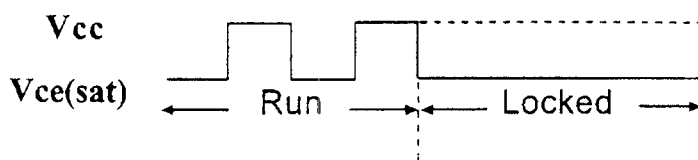
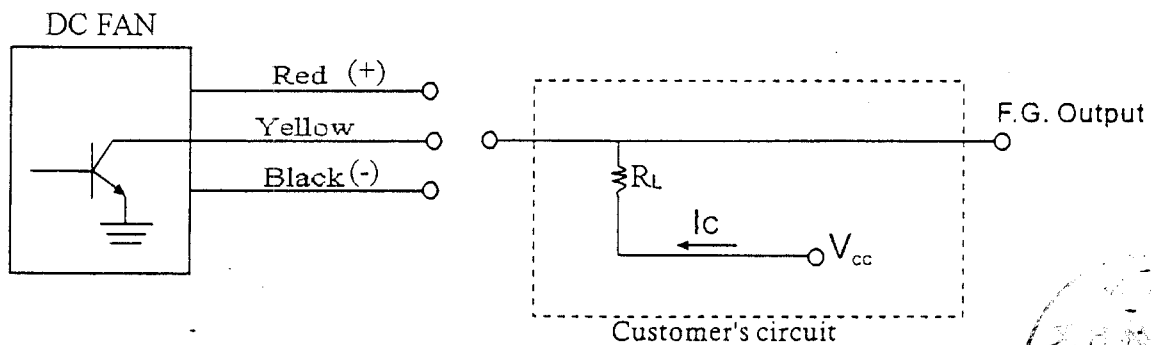

$V_{cc} = +30V \text{ max}$   
 $I_c = 10mA \text{ max}$   
 $V_{ce(sat)} = 0.5V \text{ max}$   

$$I_c = \frac{V_{cc} - V_{ce(sat)}}{R_L} \leq 10mA$$

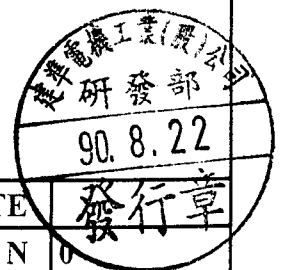
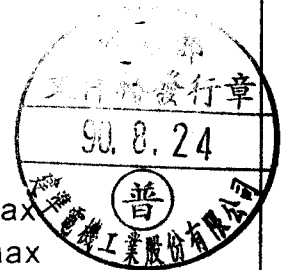

建準電機工業股份有限公司 SUNONWEALTH ELECTRIC MACHINE INDUSTRY CO., LTD.	SPEC.NO	M400601	REVISE DATE	
	ISSUE DATE	08.09.2001	EDITION	0
	PAGE	7 OF 8		

**Notes**

1. SUNON will not guarantee the products if the application conditions exceed those set out in this specification.
2. A written request should be submitted to SUNON prior to acceptance if deviation from this specification is required.
3. Caution should be exercised when handling the fan. Damages may be resulted when apply pressure to the impeller or hold the fan by the lead wires.
4. No guarantee on the products against the safety problem or failure caused by powder dust, drop of water or insect.
5. This specification sheet precedes all other information and should be used as the principal reference for the product to which it refers.
6. To satisfy the SUNON Management Information System, please indicate SPEC. NO. on every order.
7. It is important that the correct polarity is established before connecting the fan to the electrical supply. Black (0V) , Red(+V). If cautions is not taken, immediate damage may occur on fans that do not have polarity protection.
8. SUNON fans are not suitable to be used in an environment that contains aggressive or corrosive fluids.
9. Always ensure that fans are stored according to the storage temperatures specified. Do not store in an environment with a high humidity level. If the fans were stored for longer than 6 months, it is highly recommended to apply functional testing before shipping.
10. Not all fans incorporate the Lock Rotor Protection feature. For fans that do not incorporate this feature it is important not to prevent the rotation of the impeller. Doing so, will lead to failure.
11. During installation, caution should be taken when mounting the fan. Incorrect mounting can cause excess resonance, vibration and noise.
12. During testing it is important to consider safety at all times. A suitable guard should be fitted to the fan to prevent personal injury.
13. Unless otherwise stated, all tests are carried out at relative temperature and humidity conditions of 25°C, 65%.

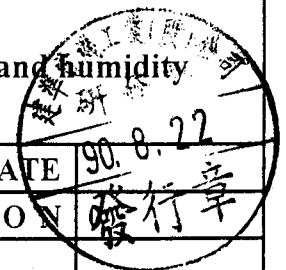
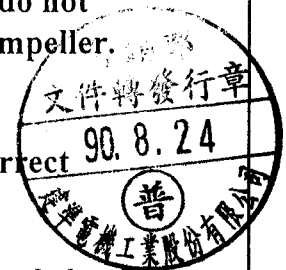

建準電機工業股份有限公司 SUNONWEALTH ELECTRIC MACHINE INDUSTRY CO., LTD.	SPEC.NO	M400601	REVISE DATE	90.8.22
	ISSUE DATE	08.09.2001	EDITION	發行章
	PAGE	8 OF 8		