

order number	lens name
0703-096-000-40	Apo-Rodagon-N 4/105

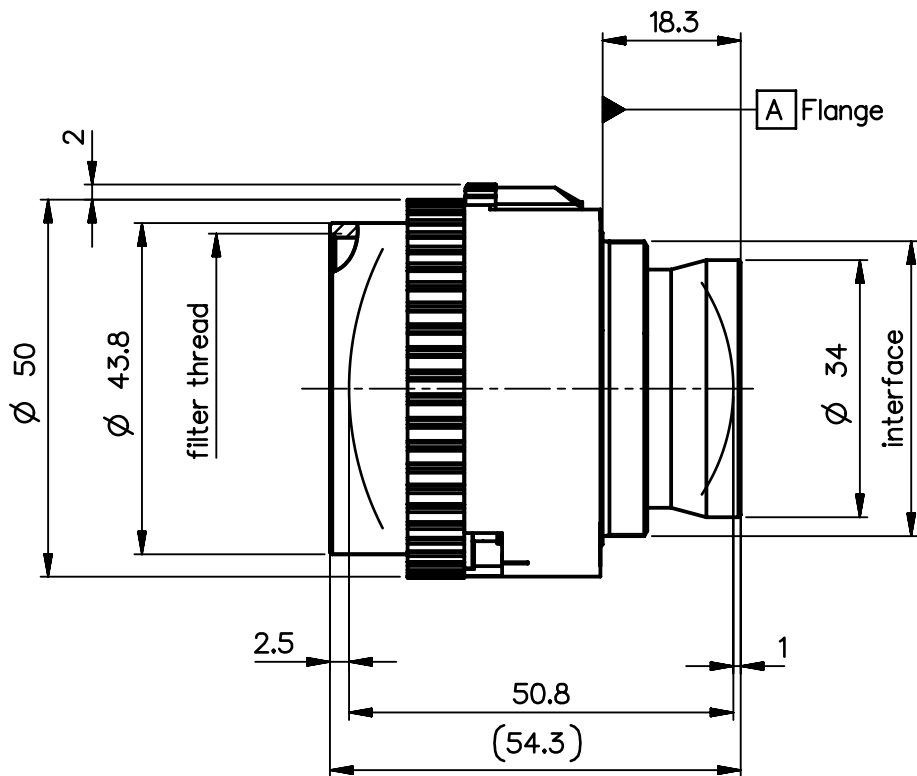

Specification		ON	7512-9131
image circle max. (mm)	100	working distance (mm)	282 - 1825
focal length f' (mm) *	105.2	interface	M39 x1/26" (Leica)
magnification β' [range]	-0.17 [-0.5 ... -0.06]	filter thread	M40.5 x0.5
spectral range λ (nm)	400 - 750	weight (g)	155

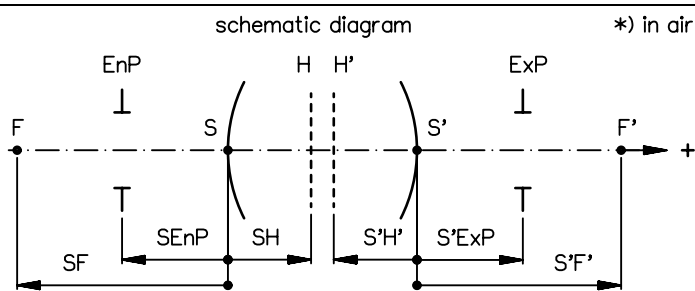

design includes CCD cover glass:		no	
SF (mm)	-74.4	f-stop	
S'F' (mm) *	81.9	\varnothing EnP	25.3
HH' (mm) *	-3.3	\varnothing Exp	25.4
SH (mm)	30.8		
S'H' (mm) *	-23.3		
SEnP (mm)	30.8		
S'Exp (mm) *	-23.3		

PROTECTIVE NOTE "DIN ISO 16016" TO BE OBSERVED	EU-D	AL-T1A	US-D	US-ML	not export controlled
	REV	ECC	DATE	APPROVED	PDM Status Freigabe
	a	Neuausg			-
	b	11-027	13.05.11	Schiffe	SCALE -
	c	11-358	13.07.11	Kuehne	MATERIAL
d	12-0013	10.01.12	Schiffe	BASIC TOLERANCING PRINCIPLE	TITLE
e	14-0184	18.08.14	Schiffe	ISO 8015	Apo-Rodagon-N 4/105
			FIRST ISSUE	DATE	NAME
			15.04.09	15.04.09	Kuehne
			CHKD	15.04.09	Schaeffler
DIN A 4	ALL DIMENSIONS ARE IN MM AND INCLUDE SURFACE TREATMENT			QIOPTRON	DRAWING NO. 0703-096-100-00-0001e
					REPLACES 0703-019-100-20
					SHEET 1 OF 1

Apo-Rodagon-N_4/105

MTF at ratio -0.17 f/ 4.0

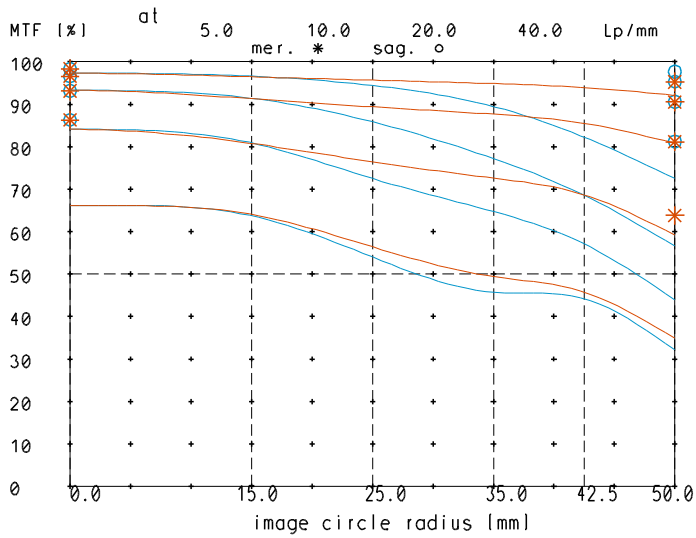

relative light fall-off at ratio -0.17

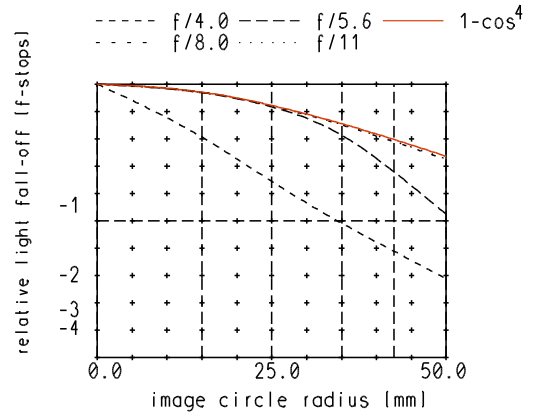

MTF at ratio -0.17 f/ 8.0

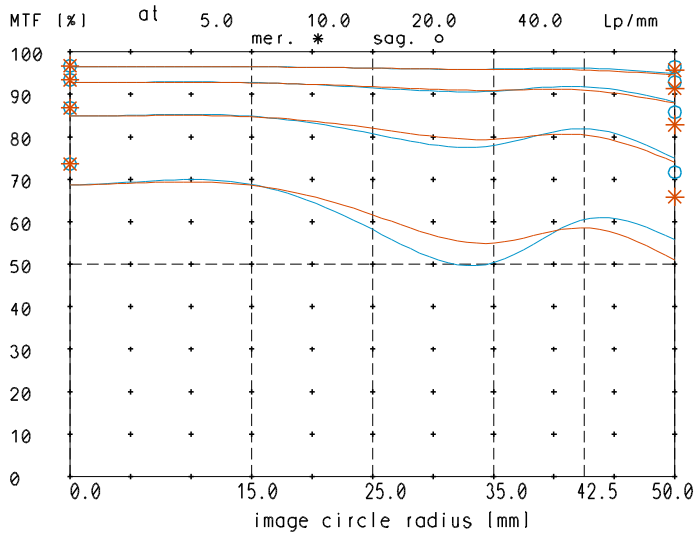

Distortion at ratio 0.05x to 0.5x

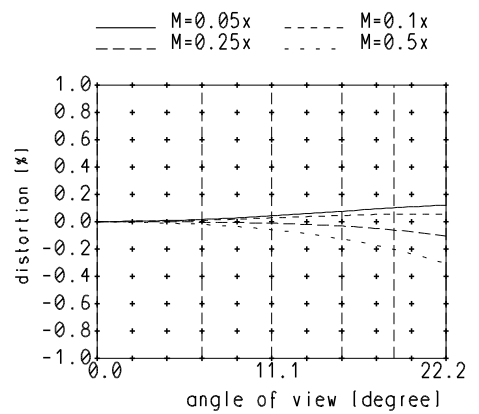

— sagittal. o Diffraction limited value
— meridional * Diffraction limited value

Longitudinal color aberration at ratio -0.17

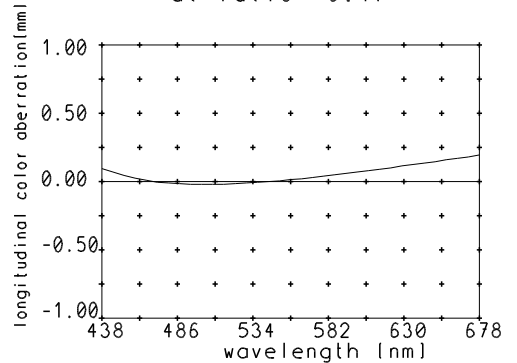

Named frequencies (line pairs/mm) in modular transfer function (MTF) as well as diagrams of relative light fall-off, distortion and longitudinal color aberration refer to film plane.