

# SMT Multi TOPLED

## Version 1.4

---

### SFH 331



#### Features:

- SMT package with red emitter (635 nm) and Si-phototransistor
- Suitable for SMT assembly
- Available on tape and reel
- Emitter and detector can be controlled separately

#### Applications

- Data transmission
- Lock bar
- Infrared interface

#### Ordering Information

Type:	Ordering Code
SFH 331-JK	Q65110A2821

**Maximum Ratings**

Parameter	Symbol	Values	Unit
Operating and storage temperature range	$T_{op}; T_{stg}$	-40 ... 100	°C
Junction temperature	$T_j$	100	°C
ESD withstand voltage (acc. to ANSI/ ESDA/ JEDEC JS-001 - HBM)	$V_{ESD}$	2000	V

**Emitter 1**

Forward current	$I_F$	30	mA
Surge current ( $t_p \leq 10 \mu s$ , $D = 0.005$ )	$I_{FSM}$	0.5	A
Reverse voltage	$V_R$	5	V
Power consumption	$P_{tot}$	100	mW
Thermal resistance junction - ambient <sup>1) page 16</sup>	$R_{thJA}$	450	K / W
Thermal resistance junction - solder point	$R_{thJS}$	350	K / W

**Phototransistor**

Collector current	$I_C$	15	mA
Collector surge current ( $\tau < 10 \mu s$ )	$I_{CS}$	75	mA
Collector-emitter voltage	$V_{CE}$	35	V
Total Power dissipation	$P_{tot}$	165	mW
Thermal resistance <sup>1) page 16</sup>	$R_{thJA}$	450	K / W

The stated maximum ratings refer to the specified chip regardless of the operating status of the other one.

**Characteristics**

Parameter	Symbol	Values	Unit
<b>Emitter 1</b>			
Peak wavelength ( $I_F = 10 \text{ mA}$ )	(typ) $\lambda_{peak}$	635	nm
Dominant wavelength ( $I_F = 10 \text{ mA}$ )	(typ) $\lambda_{dom}$	628	nm
Spectral bandwidth at 50% of $I_{max}$ ( $I_F = 10 \text{ mA}$ )	(typ) $\Delta\lambda$	45	nm
Half angle	(typ) $\varphi$	$\pm 60$	°

Parameter		Symbol	Values	Unit
Rise and fall times of $I_e$ ( 10% and 90% of $I_{e\max}$ ) ( $I_C = 100\text{ mA}$ , $t_p = 10\text{ }\mu\text{s}$ , $R_L = 50\text{ }\Omega$ )	(typ)	$t_r / t_f$	300 / 150	ns
Capacitance ( $V_R = 0\text{ V}$ , $f = 1\text{ MHz}$ )	(typ)	$C_0$	12	pF
Forward voltage ( $I_F = 10\text{ mA}$ )	(typ (max))	$V_F$	2 ( $\leq 2.6$ )	V
Reverse current ( $V_R = 5\text{ V}$ )	(typ (max))	$I_R$	0.01 ( $\leq 10$ )	$\mu\text{A}$
Luminous intensity ( $I_F = 10\text{ mA}$ )	(min)	$I_V$	6 (4 ... 12.5)	mcd

**Phototransistor** $(T_A = 25\text{ }^\circ\text{C}$ ,  $\lambda = 950\text{ nm}$ )

Wavelength of max. sensitivity	(typ)	$\lambda_{S\max}$	990	nm
Spectral range of sensitivity ( $S = 10\%$ of $S_{\max}$ )	(typ)	$\lambda$	440 ... 1150	nm
Radiant sensitive area ( $\varnothing = 240\text{ }\mu\text{m}$ )	(typ)	A	0.038	$\text{mm}^2$
Dimensions of chip area	(typ)	L x W	(typ) 0.45 x 0.45	mm x mm
Half angle	(typ)	$\varphi$	$\pm 60$	$^\circ$
Capacitance ( $V_{CE} = 0\text{ V}$ , $f = 1\text{ MHz}$ , $E = 0$ )	(typ)	$C_{CE}$	5	pF
Dark current ( $V_{CE} = 20\text{ V}$ , $E = 0$ )	(typ (max))	$I_{CE0}$	1 ( $\leq 50$ )	nA
Photocurrent ( $\lambda = 950\text{ nm}$ , $E_e = 0.1\text{ mW/cm}^2$ , $V_{CE} = 5\text{ V}$ )		$I_{PCE}$	$\geq 16$	$\mu\text{A}$
Rise and fall time ( $I_C = 1\text{ mA}$ , $V_{CE} = 5\text{ V}$ , $R_L = 1\text{ k}\Omega$ )	(typ)	$t_r, t_f$	7	$\mu\text{s}$
Collector-emitter saturation voltage ( $I_C = 5\text{ }\mu\text{A}$ , $E_e = 0.1\text{ mW/cm}^2$ )	(typ)	$V_{CEsat}$	150	mV

**Relative Spectral Emission** 2) page 16

(typ)  $I_{rel} = f(\lambda)$ ,  $T_A = 25\text{ °C}$ ,  $I_F = 20\text{ mA}$ ,  $V(\lambda) = \text{Standard Eye Response Curve}$

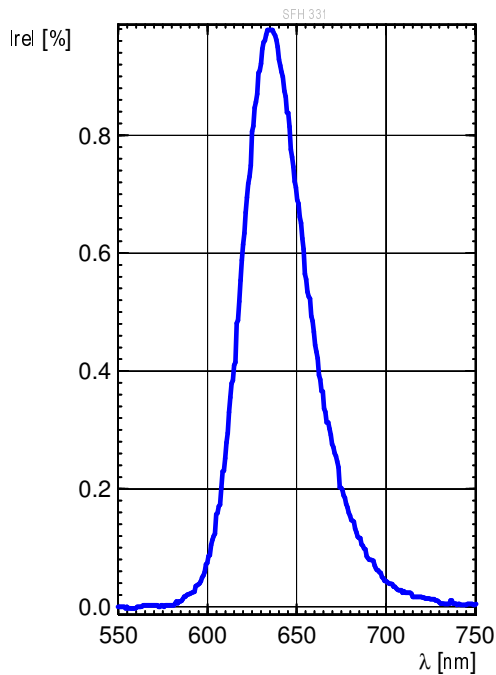

**Relative Luminous Intensity** 2) page 16

$I_V / I_{V(10\text{mA})} = f(I_F)$ ,  $T_A = 25\text{ °C}$

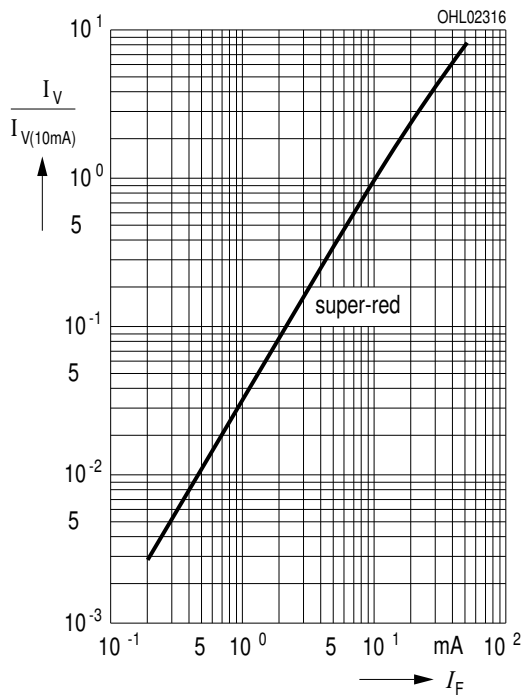

**Max. Permissible Forward Current**

$I_{F, max} = f(T_A)$

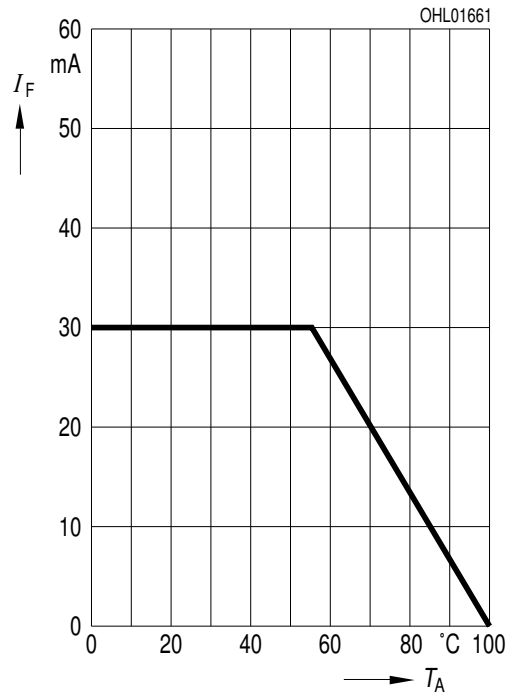

**Forward Current** <sup>2) page 16</sup>

$I_F = f(V_F), T_A = 25\text{ }^\circ\text{C}$

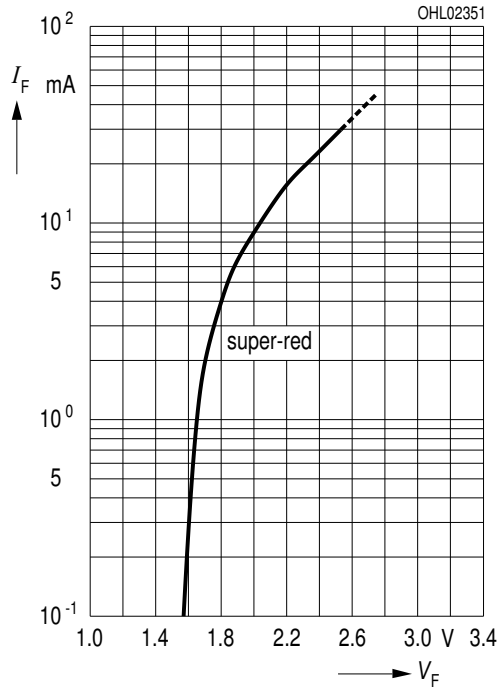

**Permissible Pulse Handling Capability**

$I_F = f(t_p), T_A = 25\text{ }^\circ\text{C}, \text{ duty cycle } D = \text{parameter}$

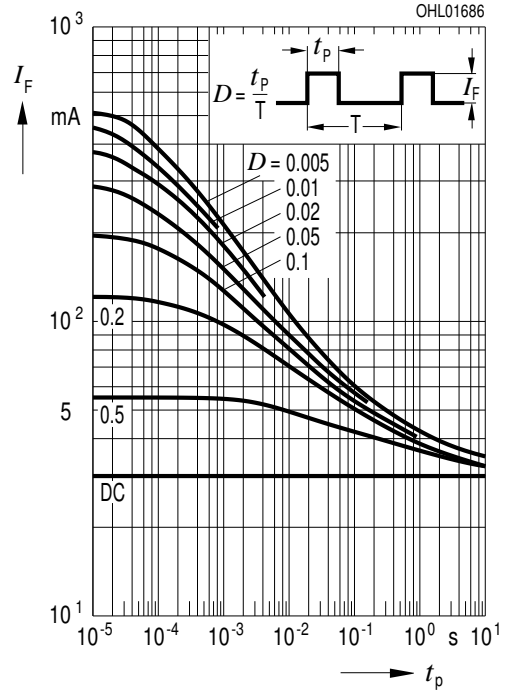

**Wavelength at Peak Emission** <sup>2) page 16</sup>

$\lambda_{\text{peak}} = f(T_A), I_F = 20\text{ mA}$

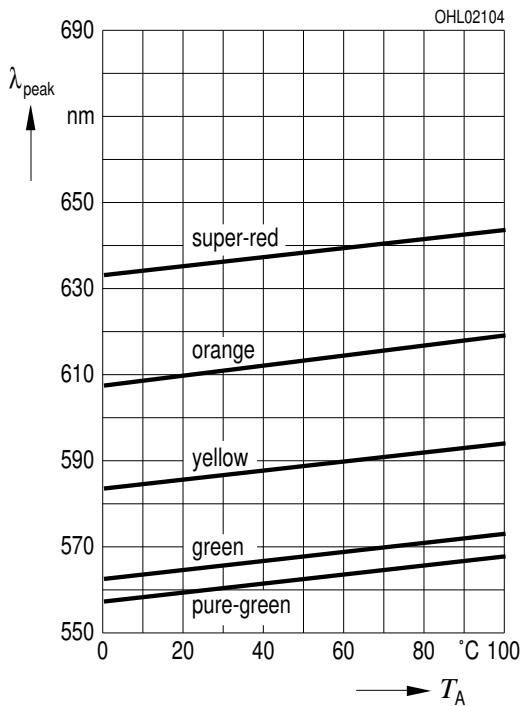

**Dominant Wavelength** <sup>2) page 16</sup>

$\lambda_{\text{dom}} = f(T_A), I_F = 20\text{ mA}$

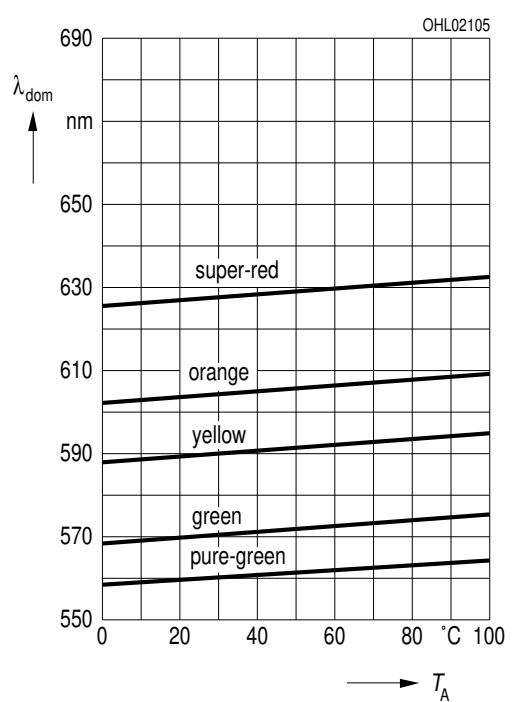

**Forward Voltage** <sup>2) page 16</sup>

$V_F = f(T_A), I_F = 10 \text{ mA}$

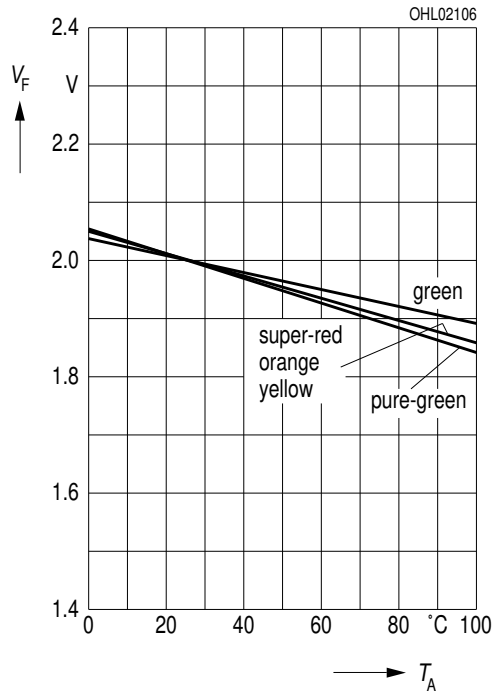

**Relative Luminous Intensity** <sup>2) page 16</sup>

$I_V / I_V(25 \text{ °C}) = f(T_A), I_F = 10 \text{ mA}$

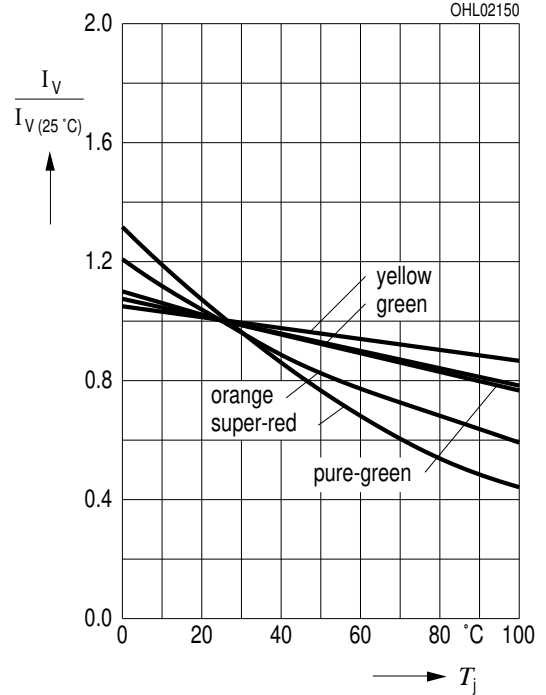

**Diagrams**  
**Phototransistor**

**Relative Spectral Sensitivity** <sup>2) page 16</sup>

$S_{rel} = f(\lambda)$

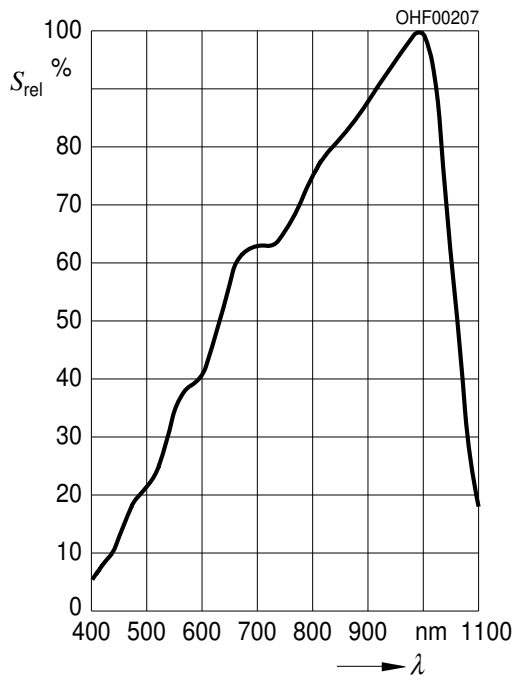

**Photocurrent** <sup>2) page 16</sup>

$I_{PCE} = f(E_e), V_{CE} = 5 V$

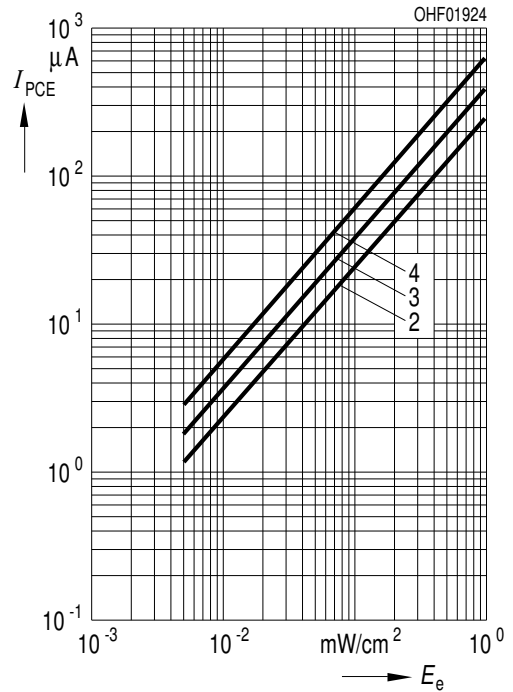

**Photocurrent** <sup>2) page 16</sup>

$I_{PCE} = f(V_{CE}), E_e = \text{Parameter}$

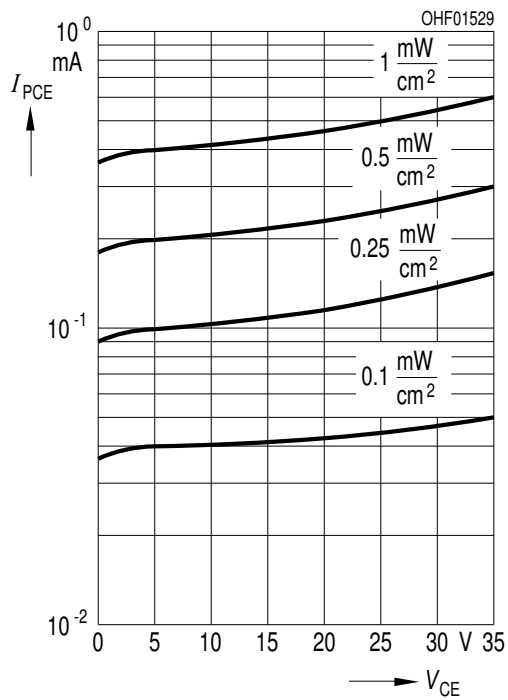

**Photocurrent** <sup>2) page 16</sup>

$I_{PCE} / I_{PCE}(25^\circ C) = f(T_A), V_{CE} = 5 V$

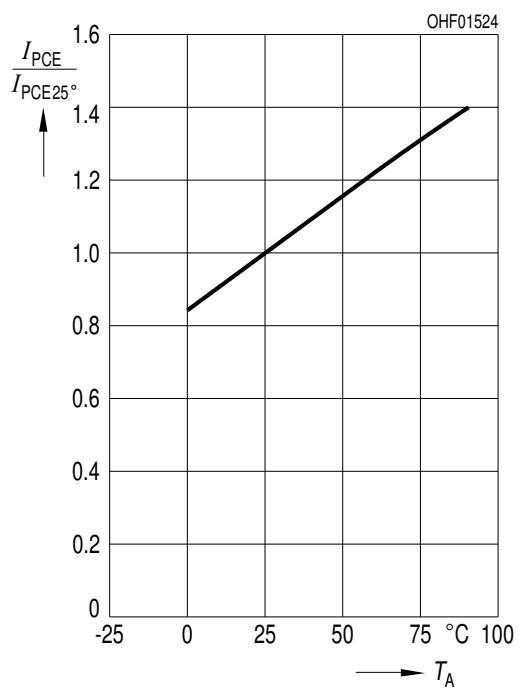

**Dark Current** 2) page 16

$I_{CEO} = f(V_{CE}), E = 0$

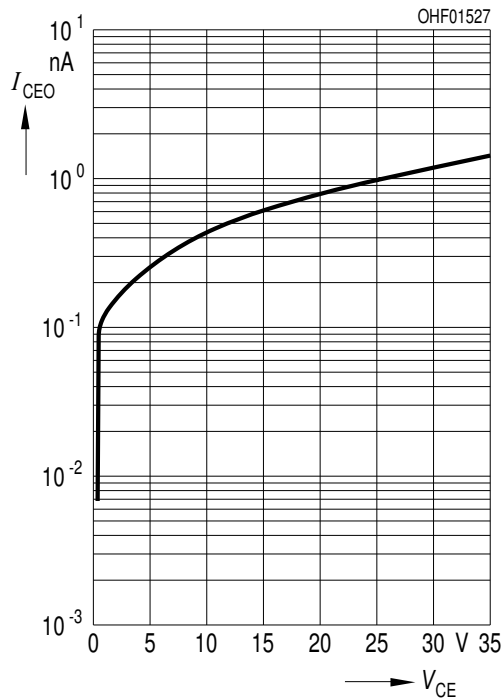

**Dark Current** 2) page 16

$I_{CEO} = f(T_A), V_{CE} = 5 V, E = 0$

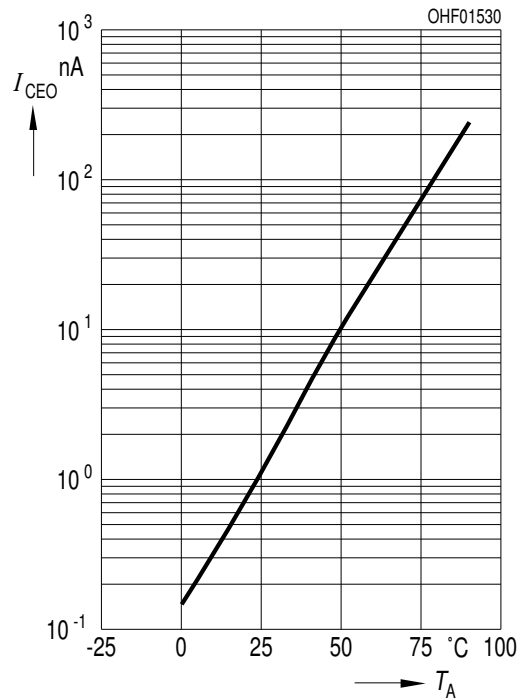

**Collector-Emitter Capacitance** 2) page 16

$C_{CE} = f(V_{CE}), f = 1 \text{ MHz}, E = 0$

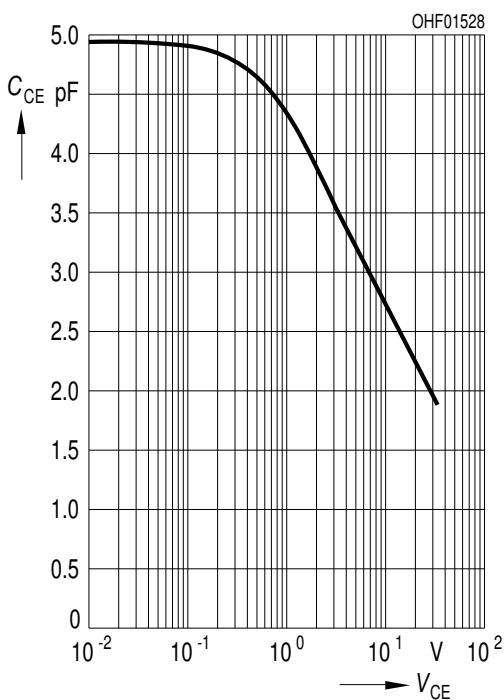

**Power Consumption**

$P_{tot} = f(T_A)$

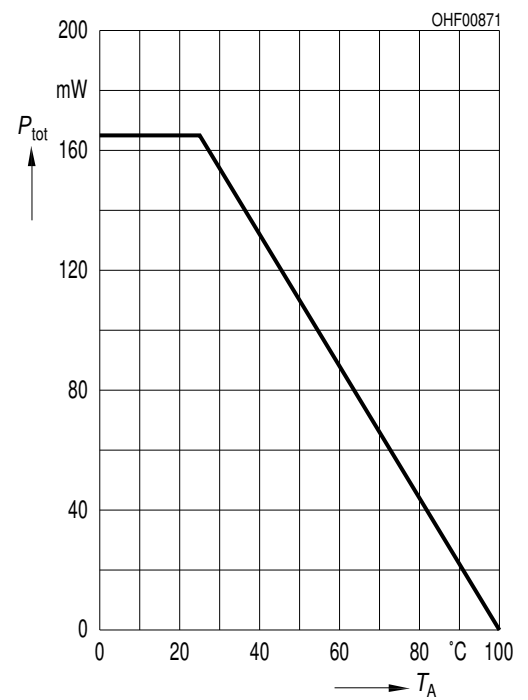



Emitter Radiation Characteristics / Phototransistor Directional Characteristics <sup>2) page 16</sup>

$$I_{rel} = f(\phi) / S_{rel} = f(\phi)$$

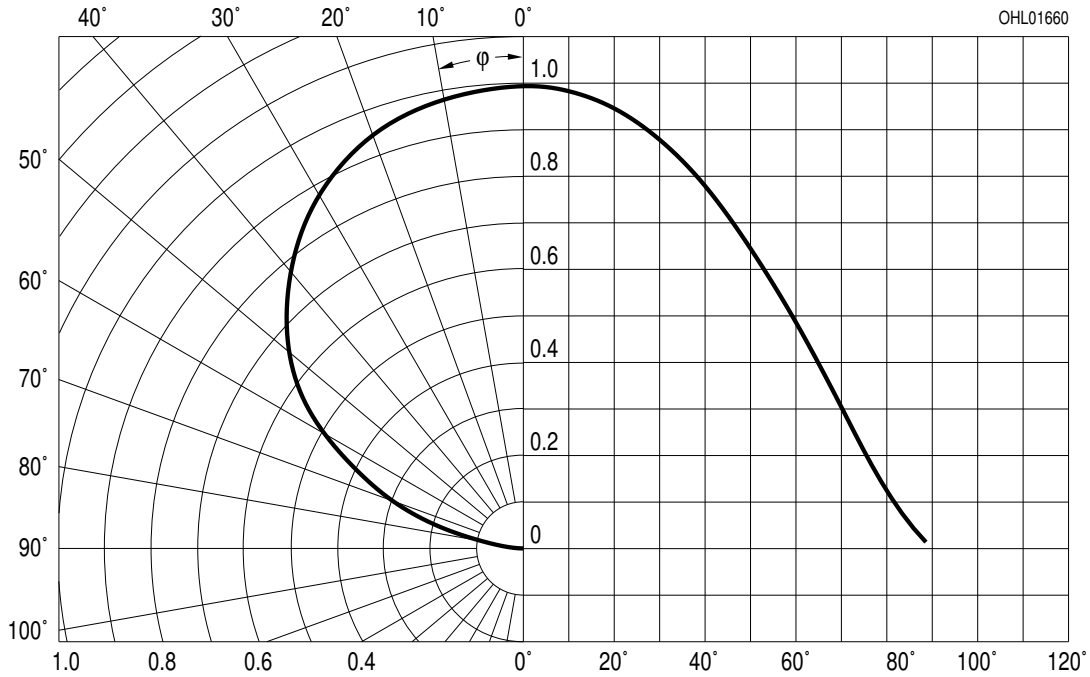

Package Outline

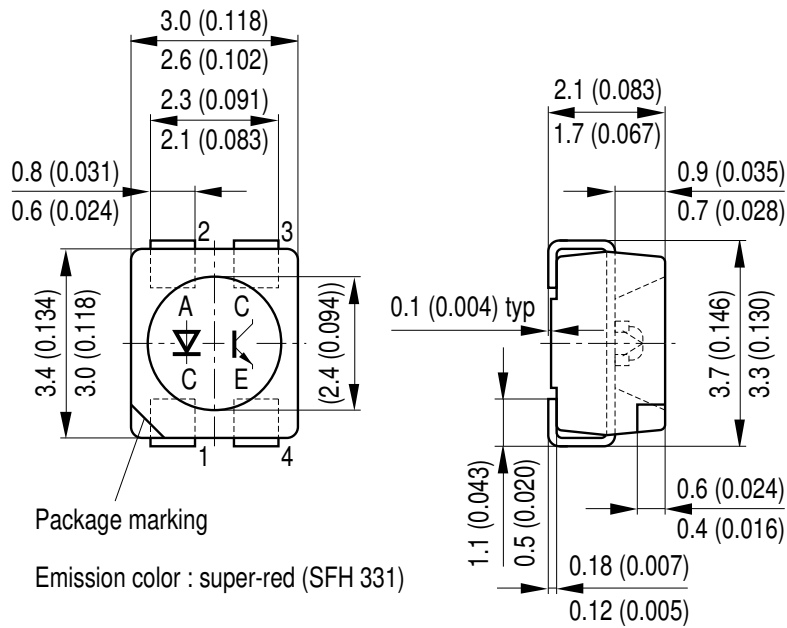

Dimensions in mm (inch).

Package

Multi TOPLED

**Approximate Weight:**

34 mg

**Recommended Solder Pad**

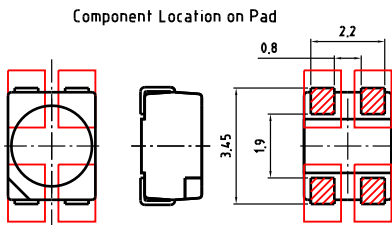
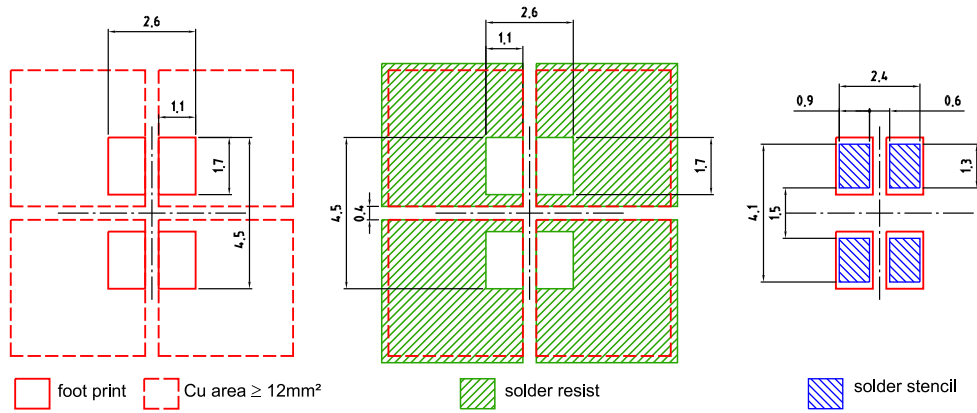

E062.3010.148 -02

Dimensions in mm.

**Reflow Soldering Profile**

Product complies to MSL Level 2 acc. to JEDEC J-STD-020E

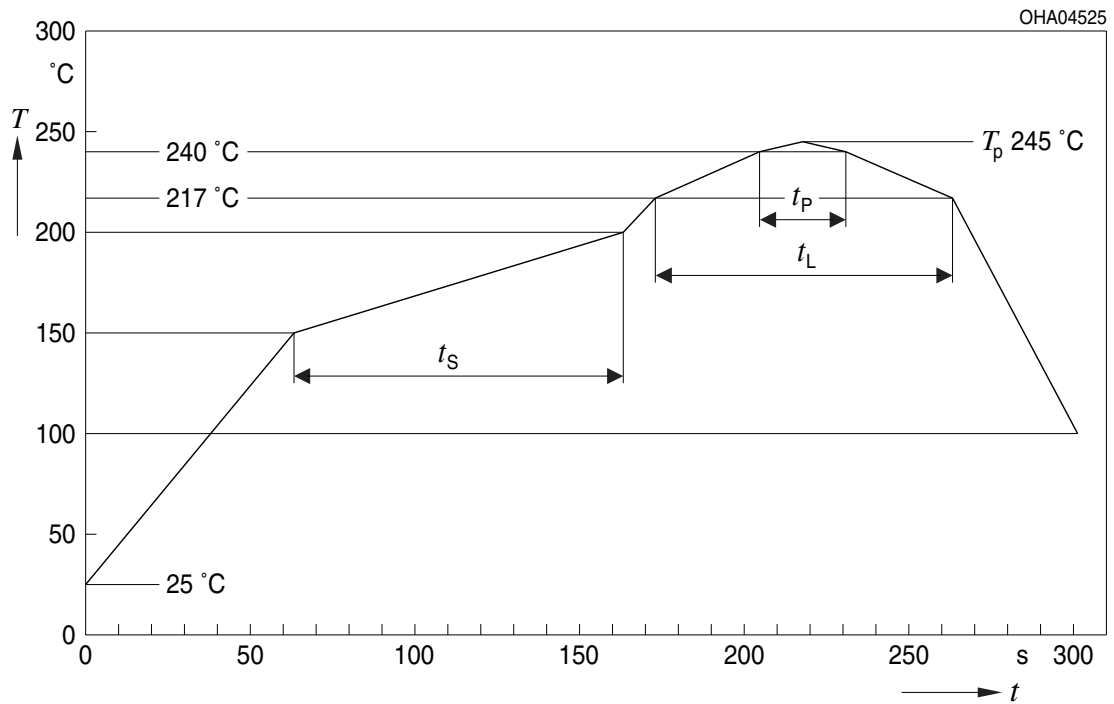

OHA04612

Profil-Charakteristik Profile Feature	Symbol Symbol	Pb-Free (SnAgCu) Assembly			Einheit Unit
		Minimum	Recommendation	Maximum	
Ramp-up Rate to Preheat*) 25 °C to 150 °C			2	3	K/s
Time $t_S$ $T_{Smin}$ to $T_{Smax}$	$t_S$	60	100	120	s
Ramp-up Rate to Peak*) $T_{Smax}$ to $T_P$			2	3	K/s
Liquidus Temperature	$T_L$	217			°C
Time above Liquidus temperature	$t_L$		80	100	s
Peak Temperature	$T_P$		245	260	°C
Time within 5 °C of the specified peak temperature $T_P - 5$ K	$t_P$	10	20	30	s
Ramp-down Rate* $T_P$ to 100 °C			3	6	K/s
Time 25 °C to $T_P$				480	s

All temperatures refer to the center of the package, measured on the top of the component

\* slope calculation  $DT/Dt$ :  $Dt$  max. 5 s; fulfillment for the whole T-range

## Taping

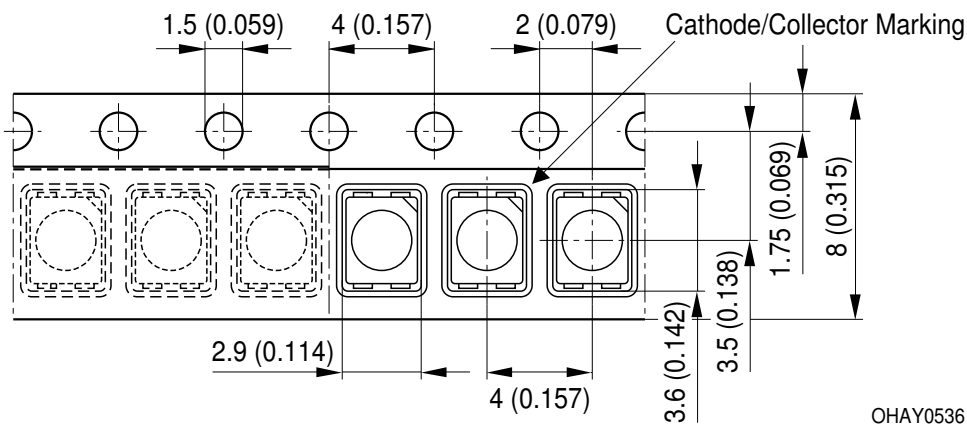

*Dimensions in mm (inch).*

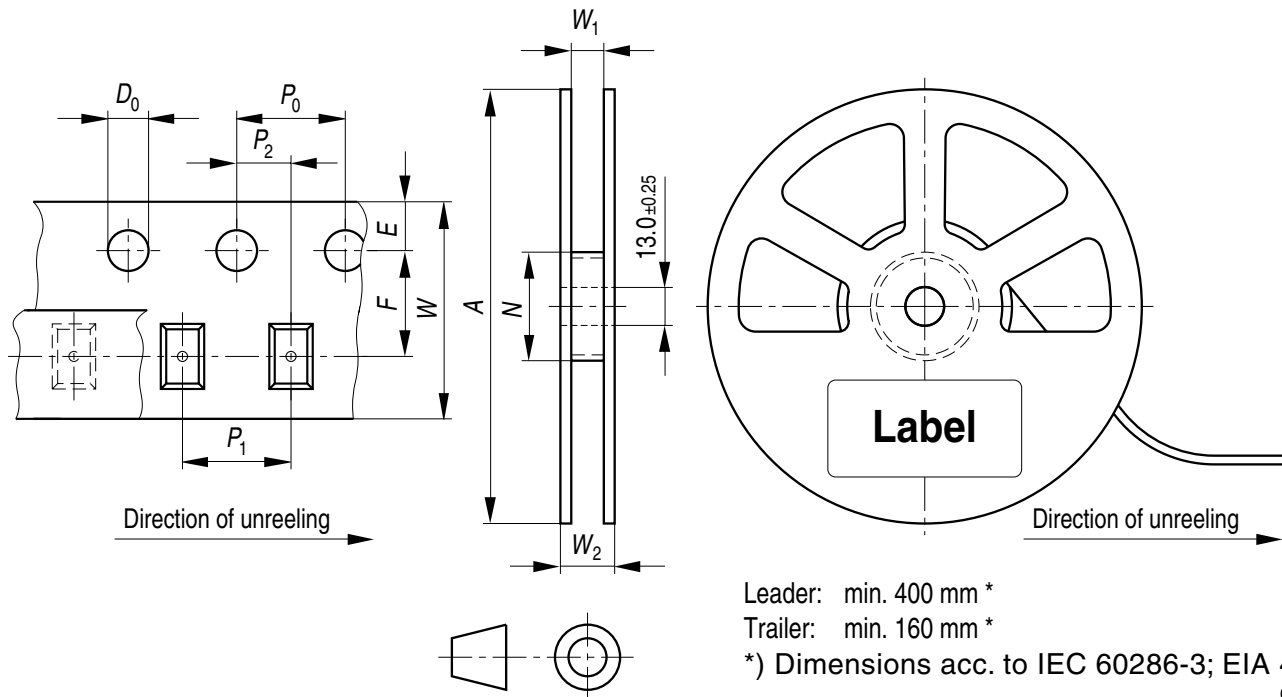
**Tape and Reel**8 mm tape with 2000 pcs. on  $\varnothing$  180 mm reel, 8000 pcs. on  $\varnothing$  330 mm reel**Tape dimensions [mm]**

W	P <sub>0</sub>	P <sub>1</sub>	P <sub>2</sub>	D <sub>0</sub>	E	F
8 + 0.3 / -0.1	4 ± 0.1	2 ± 0.05 or 4 ± 0.1	2 ± 0.05	1.5 ± 0.1	1.75 ± 0.1	3.5 ± 0.05

**Reel dimensions [mm]**

A	W	N <sub>min</sub>	W <sub>1</sub>	W <sub>2max</sub>
180	8	60	8.4 + 2	14.4

A	W	N <sub>min</sub>	W <sub>1</sub>	W <sub>2max</sub>
330	8	60	8.4 + 2	14.4

Barcode-Product-Label (BPL)

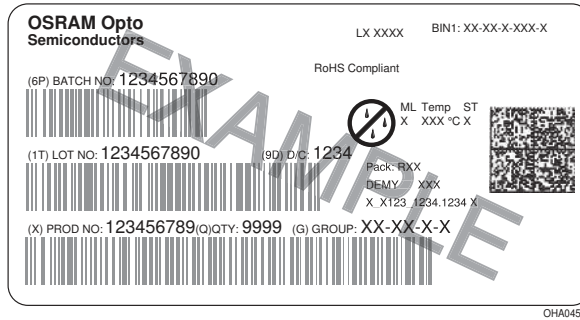

Dry Packing Process and Materials

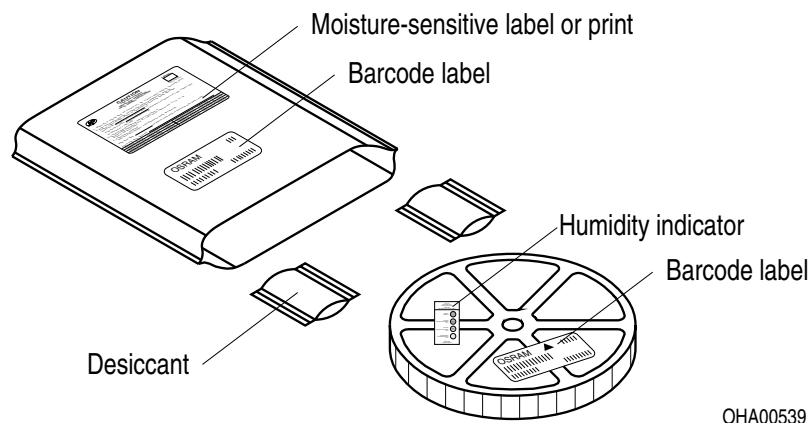

Note:

Moisture-sensitive product is packed in a dry bag containing desiccant and a humidity card. Regarding dry pack you will find further information in the internet. Here you will also find the normative references like JEDEC.

## Transportation Packing and Materials

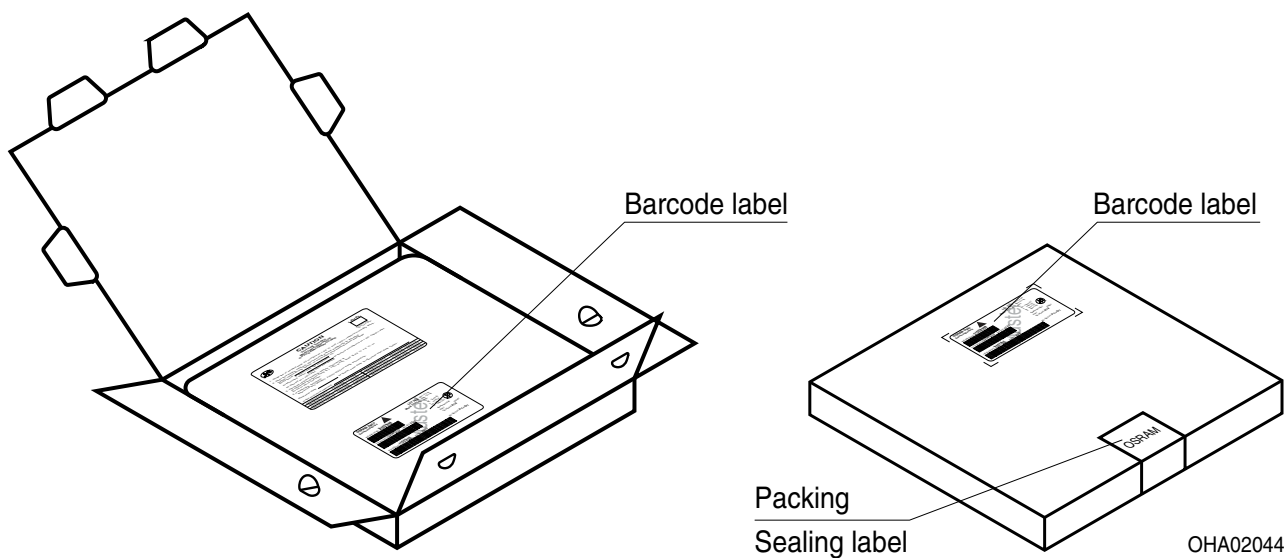

## Dimensions of transportation box in mm

Width	Length	Height
$200 \pm 5$ / $352 \pm 5$	$195 \pm 5$ / $352 \pm 5$	$30 \pm 5$ / $33 \pm 5$

**Disclaimer**

Language english will prevail in case of any discrepancies or deviations between the two language wordings.

**Attention please!**

The information describes the type of component and shall not be considered as assured characteristics.

Terms of delivery and rights to change design reserved. Due to technical requirements components may contain dangerous substances.

For information on the types in question please contact our Sales Organization. If printed or downloaded, please find the latest version in the Internet.

**Packing**

Please use the recycling operators known to you. We can also help you – get in touch with your nearest sales office.

By agreement we will take packing material back, if it is sorted. You must bear the costs of transport. For packing material that is returned to us unsorted or which we are not obliged to accept, we shall have to invoice you for any costs incurred.

**Components used in life-support devices or systems must be expressly authorized for such purpose!**

Critical components\* may only be used in life-support devices\*\* or systems with the express written approval of OSRAM OS.

\*) A critical component is a component used in a life-support device or system whose failure can reasonably be expected to cause the failure of that life-support device or system, or to affect its safety or the effectiveness of that device or system.

\*\*) Life support devices or systems are intended (a) to be implanted in the human body, or (b) to support and/or maintain and sustain human life. If they fail, it is reasonable to assume that the health and the life of the user may be endangered.

**Glossary**

- 1) **Thermal resistance:** junction - ambient, mounted on PC-board (FR4), padsized 16 mm<sup>2</sup> each
- 2) **Typical Values:** Due to the special conditions of the manufacturing processes of LED, the typical data or calculated correlations of technical parameters can only reflect statistical figures. These do not necessarily correspond to the actual parameters of each single product, which could differ from the typical data and calculated correlations or the typical characteristic line. If requested, e.g. because of technical improvements, these typ. data will be changed without any further notice.



Published by OSRAM Opto Semiconductors GmbH  
Leibnizstraße 4, D-93055 Regensburg  
www.osram-os.com © All Rights Reserved.

EU RoHS and China RoHS compliant product



此产品符合欧盟 RoHS 指令的要求；  
按照中国的相关法规和标准，不含有毒有害物质或元素。