

EL SERIES | AC OUTPUT

PANEL MOUNT SOLID STATE RELAYS

Sensata | Crydom EL Series AC output solid state relays come in a compact, 21 x 35 mm housing and offer ratings up to 30 Amps. These compact SSRs come with a pre-installed thermal pad, input LED status indicator, optional built-in overvoltage protection, and are C-UL-US and TUV certified and CE compliant. The EL Series mechanical design includes quick connect terminals and an innovative 90° bent terminals option ideal for applications with limited vertical space.



Features

- Ratings of 5A, 10A, 20A and 30A @ 24-280 VAC
- UL Recognized, TUV, CE and RoHS Compliant.
- 5, 12 and 24 VDC control input options
- Zero voltage or instantaneous turn-on outputs
- LED input status indicator
- Thermal Pad Included
- Plastic housing with min. 250 CTI rating (PLC2) for demanding applications

Applications

- Coffee Machines
- Plastic injection molding equipment
- Packaging equipment
- Professional cooking equipment
- Lighting control
- HVAC&R

PRODUCT SELECTION

| Control Voltage | 5 A | 10 A | 20 A | 30 A |
|-----------------|------------|-------------|-------------|-------------|
| 4-8 VDC | EL240A5-05 | EL240A10-05 | EL240A20-05 | EL240A30-05 |
| 10-14 VDC | EL240A5-12 | EL240A10-12 | EL240A20-12 | EL240A30-12 |
| 21-27 VDC | EL240A5-24 | EL240A10-24 | EL240A20-24 | EL240A30-24 |

Output ⁽³⁾

| Description | 5 A | 10 A | 20 A | 30 A |
|--|---------|---------|---------|---------|
| Operating Voltage (47-63Hz) [Vrms] | 24-280 | 24-280 | 24-280 | 24-280 |
| Maximum Load Current [Adc] ⁽⁴⁾ | 5 | 10 | 20 | 30 |
| Minimum Load Current [mArms] | 150 | 150 | 250 | 250 |
| Transient Overvoltage [Vpk] ⁽²⁾ | 600 | 600 | 600 | 600 |
| Maximum Surge Current (50/60Hz, 1 Cycle) [Apk] | 115/120 | 145/150 | 240/250 | 260/280 |
| Maximum I ² t for Fusing (50/60Hz 1/2 cycle) [A ² sec] | 65/60 | 100/95 | 285/260 | 338/326 |
| Minimum Off-State dv/dt @ Maximum Rated Voltage [V/μsec] | 500 | 500 | 500 | 500 |
| Maximum Off-State Leakage Current @ Rated Voltage [mArms] | 0.1 | 0.1 | 0.1 | 0.1 |
| Thermal Resistance Junction to Case (Rjc) [°C/W] | 5.5 | 3.0 | 1.7 | 0.9 |
| Maximum On-State Voltage Drop @ Rated Current [Volts] | 1.3 | 1.3 | 1.3 | 1.3 |
| Minimum Power Factor (with Maximum Load) ⁽¹⁾ | 0.7 | 0.7 | 0.7 | 0.7 |

Input ⁽³⁾

| Description | EL240Axx-05 | EL240Axx-12 | EL240Axx-24 |
|--|-------------|-------------|-------------|
| Control Voltage Range | 4-8 VDC | 10-14 VDC | 21-27 VDC |
| Minimum Turn-On Voltage | 4 VDC | 10 VDC | 21 VDC |
| Must Turn-Off Voltage | 1 VDC | 1 VDC | 1 VDC |
| Minimum Input Current | 6 mA | 10 mA | 8 mA |
| Maximum Input Current | 21 mA | 17.50 mA | 19 mA |
| Maximum Turn-On Time [msec] ⁽⁵⁾ | 1/2 Cycle | 1/2 Cycle | 1/2 Cycle |
| Maximum Turn-Off Time [msec] | 1/2 Cycle | 1/2 Cycle | 1/2 Cycle |

General ⁽²⁾

| Description | Parameters |
|--|---|
| Dielectric Strength, Input to Output (50/60Hz) | 3750 Vrms |
| Dielectric Strength, Output to Baseplate (50/60Hz) | 2500 Vrms |
| Maximum Capacitance, Input/Output | 8 pF |
| Ambient Operating Temperature Range | -30 to 80°C |
| Ambient Storage Temperature Range | -30 to 125 °C |
| Weight (typical) | 0.5 oz (14.4 g) |
| Terminals | 3/16" x 0.032" input, 1/4" x 0.032" output QC |
| SSR Mounting Screw Torque Range | 9.0-10.0 lb-in (1.0-1.13 Nm) |
| LED Input Status Indicator | Green |
| Humidity per IEC60068-2-78 | 95% non-condensing |



MECHANICAL SPECIFICATIONS

Tolerance: ± 0.02 in / 0.5 mm

All dimensions are in: inches [millimeters]

Standard Quick Connect terminals

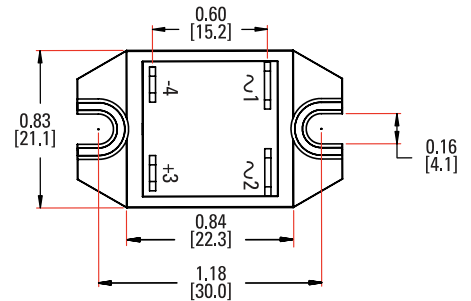
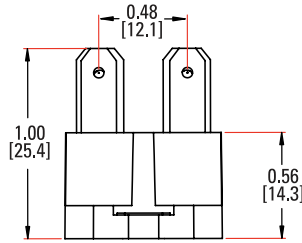
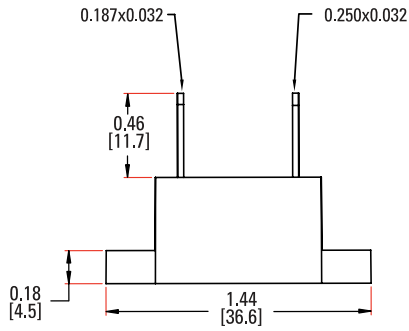

Pinout

- Terminal 1: AC load
- Terminal 2: AC load
- Terminal 3: +DC control
- Terminal 4: -DC control

90° bent Quick Connect terminals

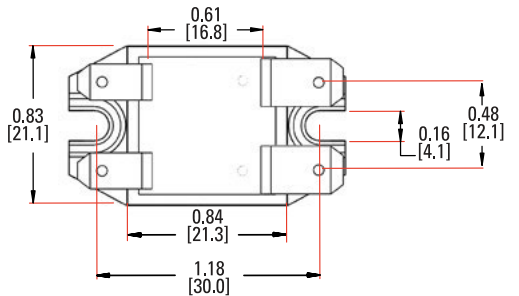
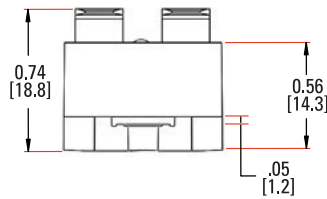
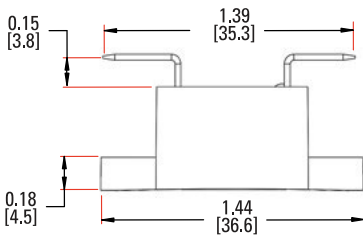

THERMAL DERATE INFORMATION

EL240A5x-xxx

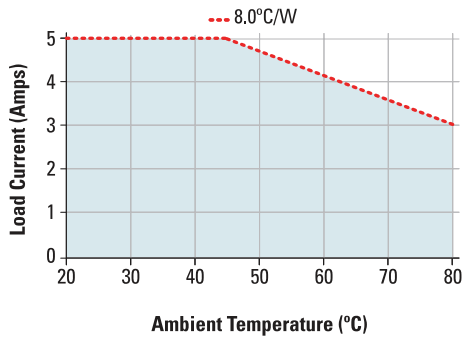

EL240A10x-xxx

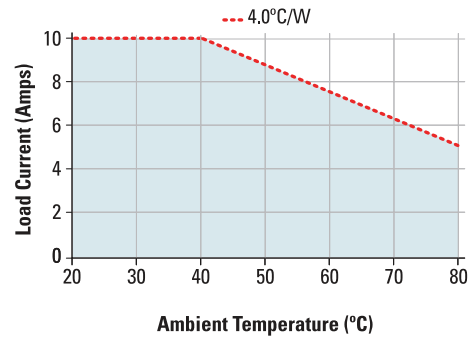

EL240A20x-xxx

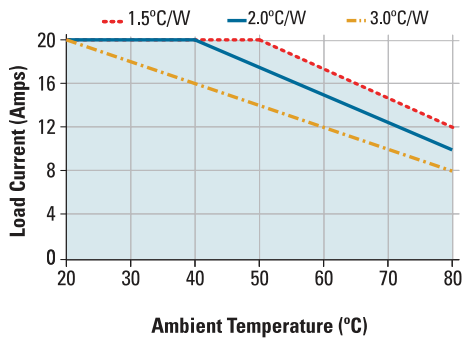

EL240A30x-xxx

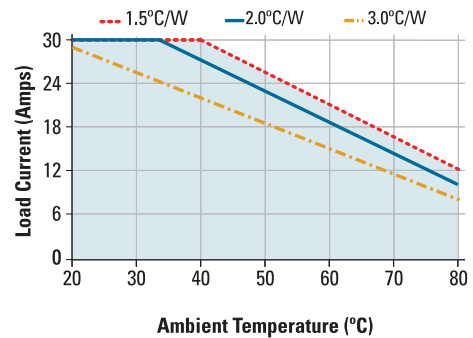



EQUIVALENT CIRCUIT BLOCK

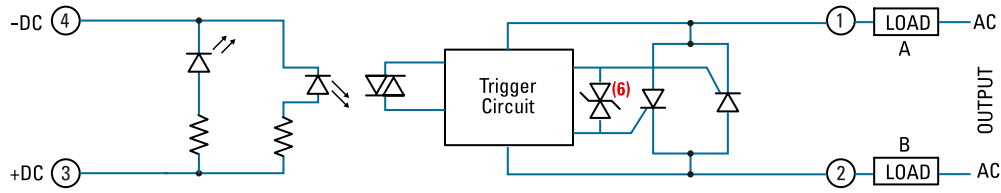

LOAD CAN BE WIRED IN POSITION A or B



MOUNTING INSTRUCTIONS

Choose one of the two mounting options and follow the instructions.

Mounting on Heat Sinks

- Select adequate heat sink. (Please refer to thermal derating curves for the specific model)
- Be sure that thermal pad is pre-installed before installing over the heat sink.
- EL mounting slots have a diameter of 0.16 in (4.0 mm). Two screws are needed (not included) to mount the EL onto heat sink (See fig. 1). Recommended screw size is 8-32 (UNC standard) or M4 (metric).
- Before applying full torque tighten down both screws until they contact the baseplate. Then, tighten them to 9.0-10.0 lb-in (1.0-1.13 Nm).
- For optimal thermal performance heat sink fins should be oriented vertically to promote natural convection airflow.

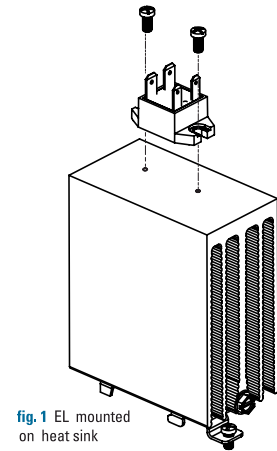

fig. 1 EL mounted on heat sink

Mounting on Panels

- Locate the panel section on which the EL will be mounted. Panel mount surface must provide adequate heat sinking capability, uncoated, clean, flat (0.004 in/in recommended) and preferably aluminum.
- Be sure that thermal pad is pre-installed before install over the heatsink.
- EL mounting slots have a diameter of 0.16 in (4.0 mm). Two screws are needed (not included) to mount the EL onto panel. Choose screw length considering the mounting surface hole depth and that the SSR flange thickness is 0.125 in (3.2 mm).
- Before applying full torque tighten down both screws until they contact the baseplate. Then, tighten them to 10 lb-in (1.13 Nm).

Transient Protection

Transients are common on AC power lines, and in extreme cases, may pose a risk for the proper operation and reliability of the SSR and its load. The load which the SSR controls may also generate transients itself. Therefore, inclusion of transient protection for the SSR is highly recommended. Internal transient protection is standard in certain Crydom SSR models, and optionally available in others. The user may also install transient protection external to the SSR for additional protection. Contact Crydom technical support for additional information on use of transient protection for AC output SSRs.

Important Considerations

Be sure to use input and output voltages within operating ranges. LED indicates only input status. It does not represent output status.



WIRING DIAGRAMS

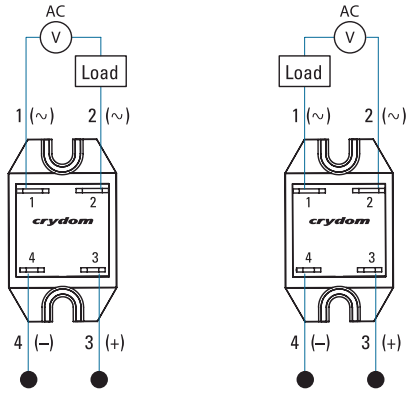

ORDERING OPTIONS

Example : EL240A30R-05NP

| | | | | | | | | |
|---|----|------|----|---|---|----|---|---|
| Series | EL | 240A | 30 | R | - | 05 | N | P |
| EL | | | | | | | | |
| Output Voltage | | | | | | | | |
| 240A : 24-280 VAC | | | | | | | | |
| Rated Load Current | | | | | | | | |
| 5 : 5 Amps 10 : 10 Amps 20 : 20 Amps 30 : 30 Amps | | | | | | | | |
| Switching Type | | | | | | | | |
| Blank : Zero Voltage Turn-On R : Instantaneous Turn-On | | | | | | | | |
| Control Voltage | | | | | | | | |
| 05 : 4-8 VDC 12 : 10-14 VDC 24 : 21-27 VDC | | | | | | | | |
| Termination | | | | | | | | |
| Blank : Standard Quick Connect N : 90° bent Quick Connect (30 Amps only) | | | | | | | | |
| Overvoltage Protection | | | | | | | | |
| Blank : Not Included P : Included (Only for 30 Amps, Zero Voltage models) ⁽¹⁾⁽²⁾ | | | | | | | | |

Required for valid part number
 For options only and not required for valid part number



GENERAL NOTES

- (1) For option P minimum power factor (at maximum load) is 0.9
- (2) In models with built-in overvoltage protection ("P" option), the output will self trigger between 450-600Vpk, not suitable for capacitive loads.
- (3) All parameters at 25°C unless otherwise specified.
- (4) When mounted to the proper size heat sink (see derating curves).
- (5) Turn-on time for Instantaneous turn-on versions is 0.02 msec
- (6) Elective Overvoltage Protection, "P" option.

AGENCY APPROVALS & CERTIFICATIONS

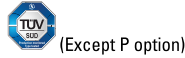

Certification in accordance with:

United States Standard for Industrial Control Equipment - UL 508 and
Canadian Standard Association for Industrial Control Equipment – C22.2 No. 14.

TUV SUD according to IEC 60335-1 and EN 62314:2006

Vibration and Shock Resistance:
IEC 61373 : Category 1, Class B.

| Electromagnetic Compatibility | | | | |
|---|--|--------------------------|-------------------|-------------|
| Generic Standard | Immunity Tests | Test Specification Level | | Performance |
| IEC 61000-6-2 Immunity for Industrial Environments | Electrostatic Discharge IEC 61000-4-2 | 8kV air discharge | | Criterion A |
| | | 6kV contact discharge | | Criterion A |
| | Fast transients (burst) IEC 61000-4-4 | Output | 5kHz | Criterion B |
| | | Input | 5kHz | Criterion B |
| | Surge IEC 61000-4-5 | Output | 1kV Line to Line | Criterion B |
| | | | 2kV Line to Earth | Criterion B |

WARNINGS



RISK OF MATERIAL DAMAGE AND HOT ENCLOSURE

- The product's side panels may be hot, allow the product to cool before touching
- Follow proper mounting instructions including torque values
- Do not allow liquids or foreign objects to enter this product

Failure to follow these instructions can result in serious injury, or equipment damage.



HAZARD OF ELECTRIC SHOCK, EXPLOSION OR ARC FLASH

- Disconnect all power before installing or working with this equipment
- Verify all connections and replace all covers before turning on power

Failure to follow these instructions will result in death or serious injury.

Sensata Technologies, Inc. ("Sensata") data sheets are solely intended to assist designers ("Buyers") who are developing systems that incorporate Sensata products (also referred to herein as "components"). Buyer understands and agrees that Buyer remains responsible for using its independent analysis, valuation, and judgment in designing Buyer's systems and products. Sensata data sheets have been created using standard laboratory conditions and engineering practices. Sensata has not conducted any testing other than that specifically described in the published documentation for a particular data sheet. Sensata may make corrections, enhancements, improvements, and other changes to its data sheets or components without notice.

Buyers are authorized to use Sensata data sheets with the Sensata component(s) identified in each particular data sheet. HOWEVER, NO OTHER LICENSE, EXPRESS OR IMPLIED, BY ESTOPPEL OTHERWISE TO ANY OTHER SENSATA INTELLECTUAL PROPERTY RIGHT, AND NO LICENSE TO ANY THIRD PARTY TECHNOLOGY OR INTELLECTUAL PROPERTY RIGHT, IS GRANTED HEREIN. SENSATA DATA SHEETS ARE PROVIDED "AS IS". SENSATA MAKES NO WARRANTIES OR REPRESENTATIONS WITH REGARD TO THE DATA SHEETS OR USE OF THE DATA SHEETS, EXPRESS, IMPLIED, OR STATUTORY, INCLUDING ACCURACY OR COMPLETENESS. SENSATA DISCLAIMS ANY WARRANTY OF TITLE AND ANY IMPLIED WARRANTIES OF MERCHANTABILITY, FITNESS FOR A PARTICULAR PURPOSE, QUIET ENJOYMENT, QUIET POSSESSION, AND NON-INFRINGEMENT OF ANY THIRD PARTY INTELLECTUAL PROPERTY RIGHTS WITH REGARD TO SENSATA DATA SHEETS OR USE THEREOF.

All products are sold subject to Sensata's terms and conditions of sale supplied at www.sensata.com SENSATA ASSUMES NO LIABILITY FOR APPLICATIONS ASSISTANCE OR THE DESIGN OF BUYERS' PRODUCTS. BUYER ACKNOWLEDGES AND AGREES THAT IT IS SOLELY RESPONSIBLE FOR COMPLIANCE WITH ALL LEGAL, REGULATORY, AND SAFETY-RELATED REQUIREMENTS CONCERNING ITS PRODUCTS, AND ANY USE OF SENSATA COMPONENTS IN ITS APPLICATIONS, NOTWITHSTANDING ANY APPLICATIONS-RELATED INFORMATION OR SUPPORT THAT MAY BE PROVIDED BY SENSATA.

Mailing Address: Sensata Technologies, Inc., 529 Pleasant Street, Attleboro, MA 02703, USA

CONTACT US

Americas

+1 (877) 502 5500
sales.crydom@sensata.com

Europe, Middle East & Africa

+44 (1202) 416170
ssr-info.eu@sensata.com

Asia Pacific

sales.isasia@list.sensata.com
China +86 (21) 2306 1500
Japan +81 (45) 277 7117
Korea +82 (31) 601 2004
India +91 (80) 67920890
Rest of Asia +886 (2) 27602006
ext 2808