

# ioThinX 4510 Series

Advanced modular remote I/O adapter with built-in serial ports



## Feature and Benefits

- Easy tool-free installation and removal
- Easy web configuration and reconfiguration
- Built-in Modbus RTU gateway function
- Supports Modbus/SNMP/RESTful API
- Supports up to 32 I/O modules
- -40 to 75°C wide operating temperature model available

## Certifications



## Introduction

The ioThinX 4510 Series is an advanced modular remote I/O product with a unique hardware and software design, making it an ideal solution for a variety of industrial data acquisition applications. The ioThinX 4510 Series has a unique mechanical design that reduces the amount of time required for installation and removal, simplifying deployment and maintenance. In addition, the ioThinX 4510 Series supports Modbus RTU Master protocol for retrieving field site data from serial meters and also supports OT/IT protocol conversion.

## Easy Tool-Free Installation and Removal

The ioThinX 4500 Series has a unique mechanical design that reduces the amount of time required for installation and removal. In fact, screwdrivers and other tools are not required for any part of the hardware installation, including mounting the device on a DIN-rail, as well as connecting the wiring for both communication and I/O signal acquisition. Furthermore, no tools are required to remove the ioThinX from a DIN-rail. Removing all of the modules from a DIN-rail is also easy using the latch and release tab.

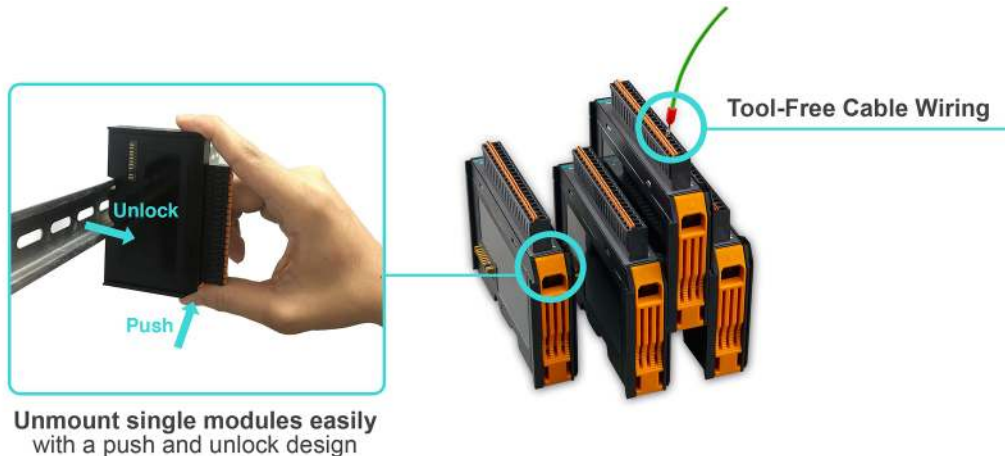

## Easy Web Configuration/Reconfiguration

For modular remote I/O setups, one of the greatest difficulties is duplicating configuration settings to the current modules with different module combinations. After adding, moving, or deleting one of the modules, settings of the unchanged modules, including the Modbus address and RESTful APIs to the upper software, need to be reconfigured. The ioThinX 4510's user-friendly web configuration tool was designed specifically to make configuration and reconfiguration easy; no reconfiguration efforts are required for the unchanged modules. In addition, the ioThinX 4510's web interface supports module/channel unique names. This feature also applies to Modbus TCP and RESTful API, saving users considerable amounts of time on development and deployment.

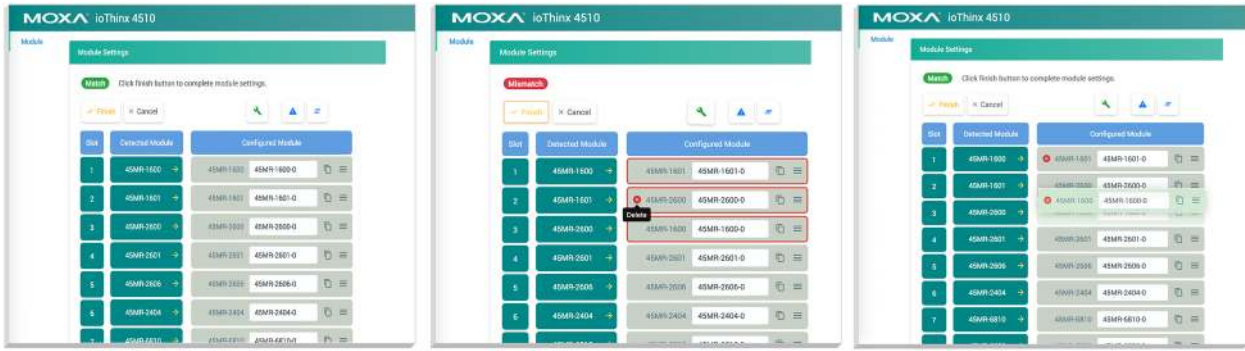

## Built-In Modbus RTU Gateway Function

The ioThinx 4510 supports Modbus RTU Master for retrieving field site data from serial meters. After collecting data, users can convert serial data to a variety of protocols, including Modbus TCP, SNMP, and RESTful, allowing users to get field site data in their protocol of choice. This two-in-one design reduces system complexity and the amount of space required in the network topology, as well as overall installation time. In addition, you can extend the useful life of legacy devices by connecting them to Ethernet and accessing the devices using a preferred protocol.

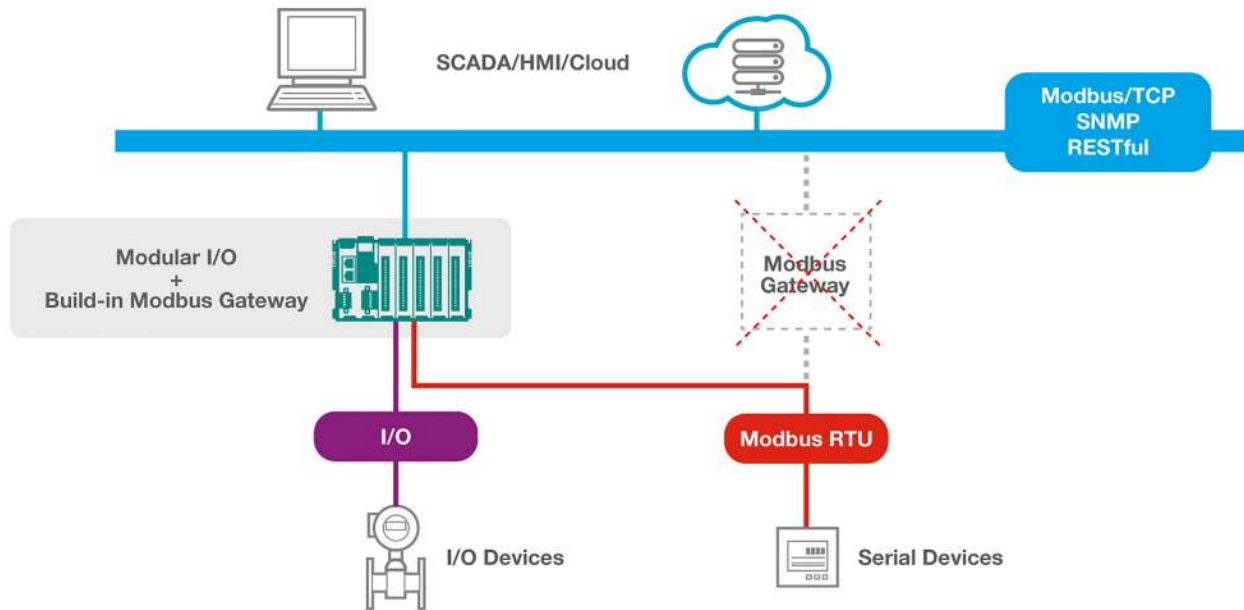

## I/O to IT/OT Protocol Conversion

The ioThinx 4510 does just what you need by supporting the most often-used protocols for retrieving I/O data. Most IT engineers use SNMPv1/v2c/v3 or RESTful API protocols, but IA engineers are more familiar with Operational Technologies (OT), such as Modbus. The ioThinx 4510 makes it possible for both IT and OT engineers to conveniently retrieve data from the same I/O device. The ioThinx 4510 speaks several different protocols, including Modbus TCP for OT engineers, as well as SNMP and RESTful API for IT engineers. The ioThinx 4510 retrieves I/O data and converts the data to any of these protocols, allowing you to get your applications connected easily and effortlessly.

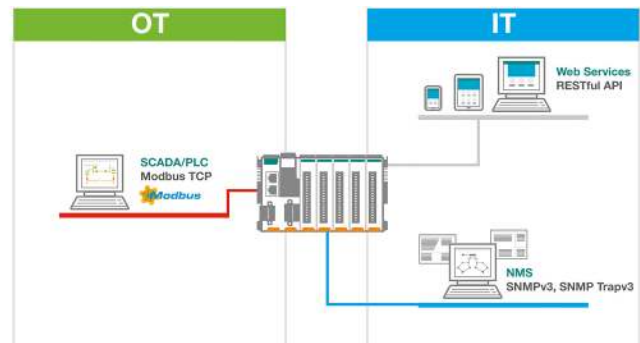

## Specifications

### Input/Output Interface

Buttons	Reset button
Expansion Slots	Up to 32 <sup>1</sup>
Isolation	3k VDC or 2k Vrms

1. Compatible with the ioThinx 4500 Series (45MR) Modules only

## Ethernet Interface

10/100BaseT(X) Ports (RJ45 connector)	2, 1 MAC address (Ethernet bypass)
Magnetic Isolation Protection	1.5 kV (built-in)

## Ethernet Software Features

Configuration Options	Web Console (HTTP), Windows Utility (IOxpress)
Industrial Protocols	Modbus TCP Server (Slave), RESTful API, SNMPv1/v2c/v3
Management	SNMPv1/v2c/v3, DHCP Client, IPv4, HTTP, UDP, TCP/IP

## Serial Interface

Connector	Spring-type Euroblock terminal
Serial Standards	RS-232/422/485
No. of Ports	1 x RS-232/422 or 2 x RS-485 (2 wire)
Baudrate	1200 bps to 115.2 kbps
Flow Control	RTS/CTS
Parity	None, Even, Odd
Stop Bits	1, 2
Data Bits	8

## Serial Signals

RS-232	TxD, RxD, RTS, CTS, GND
RS-422	Tx+, Tx-, Rx+, Rx-, GND
RS-485-2w	Data+, Data-, GND

## Serial Software Features

Industrial Protocols	Modbus RTU Client (Master)
----------------------	----------------------------

## System Power Parameters

Power Connector	Spring-type Euroblock terminal
No. of Power Inputs	1
Input Voltage	12 to 48 VDC
Power Consumption	800 mA @ 12 VDC
Over-Current Protection	1 A @ 25°C
Over-Voltage Protection	55 VDC
Output Current	1 A (max.)

## Field Power Parameters

Power Connector	Spring-type Euroblock terminal
No. of Power Inputs	1
Input Voltage	12/24 VDC
Over-Current Protection	2.5 A @ 25°C

Over-Voltage Protection	33 VDC
Output Current	2 A (max.)
<b>Physical Characteristics</b>	
Wiring	Serial cable, 16 to 28 AWG Power cable, 12 to 26 AWG
Strip Length	Serial cable, 9 to 10 mm Power cable, 12 to 13 mm
Housing	Plastic
Dimensions	42.3 x 99 x 75 mm (1.67 x 3.9 x 2.95 in)
Weight	173.5 g (0.382 lb)
Installation	DIN-rail mounting
<b>Standards and Certifications</b>	
EMC	EN 55032/24
EMI	CISPR 32, FCC Part 15B Class A
EMS	IEC 61000-4-2 ESD: Contact: 4 kV; Air: 8 kV IEC 61000-4-3 RS: 80 MHz to 1 GHz: 3 V/m IEC 61000-4-4 EFT: Power: 2 kV; Signal: 1 kV IEC 61000-4-5 Surge: Power: 2 kV; Signal: 1 kV IEC 61000-4-6 CS: 10 V IEC 61000-4-8 PFMF
Shock	IEC 60068-2-27
Vibration	IEC 60068-2-6
<b>Environmental Limits</b>	
Operating Temperature	ioThinX 4510: -20 to 60°C (-4 to 140°F) ioThinX 4510-T: -40 to 75°C (-40 to 167°F)
Storage Temperature (package included)	-40 to 85°C (-40 to 185°F)
Ambient Relative Humidity	5 to 95% (non-condensing)
Altitude	Up to 4000 m <sup>2</sup>
<b>Declaration</b>	
Green Product	RoHS, CRoHS, WEEE
<b>MTBF</b>	
Time	1,451,040 hrs
Standards	Telcordia SR332
<b>Warranty</b>	
Warranty Period	5 years
Details	See <a href="http://www.moxa.com/warranty">www.moxa.com/warranty</a>

2. Please contact Moxa if you require products guaranteed to function properly at higher altitudes.

## Package Contents

Device	1 x ioThinx 4510 Series remote I/O
Installation Kit	1 x terminal block, 5-pin, 5.00 mm 1 x terminal block, 5-pin, 3.81 mm
Documentation	1 x quick installation guide 1 x warranty card

## Dimensions

### Top/Side/Bottom Panels

Unit: mm (inch)

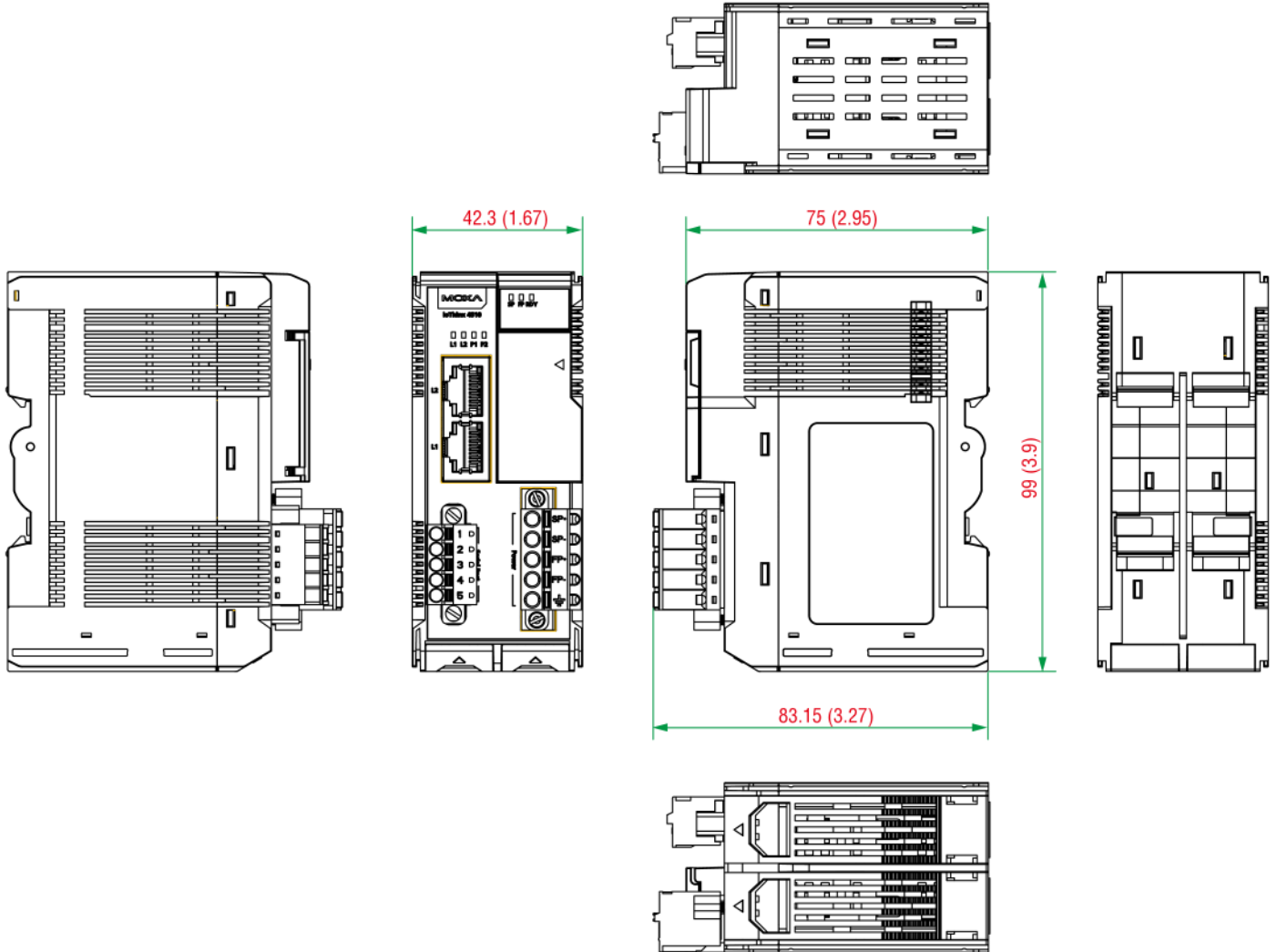

## Side Cover

Unit: mm (inch)

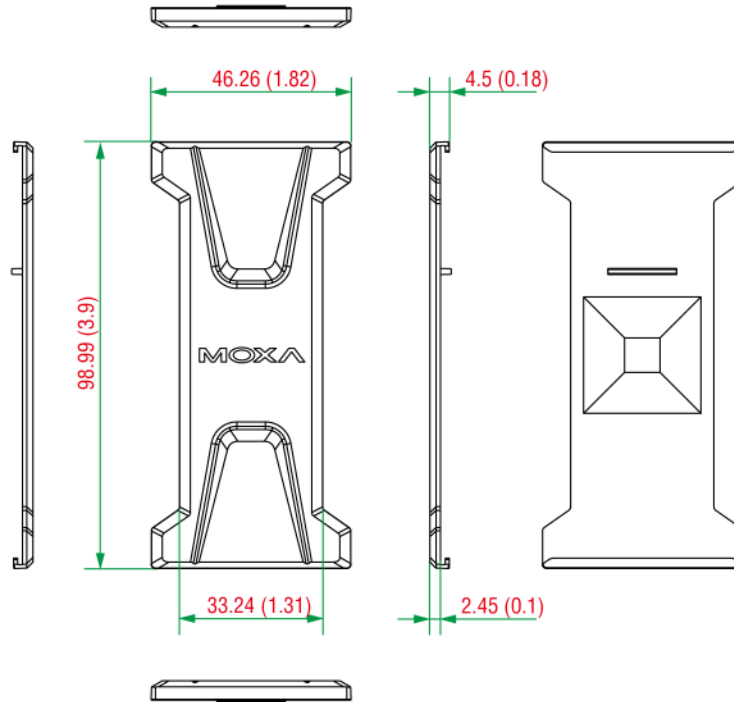

## Ordering Information

Model Name	Ethernet Interface	Serial Interface	No. of Support I/O Modules	Operating Temp.
ioThinX 4510	2 x RJ45	RS-232/RS-422/RS-485	32	-20 to 60°C
ioThinX 4510-T	2 x RJ45	RS-232/RS-422/RS-485	32	-40 to 75°C

## Accessories (sold separately)

### IO Modules

45MR-1600	Module for the ioThinX 4500 Series, 16 DIs, 24 VDC, PNP, -20 to 60°C operating temperature
45MR-1600-T	Module for the ioThinX 4500 Series, 16 DIs, 24 VDC, PNP, -40 to 75°C operating temperature
45MR-1601	Module for the ioThinX 4500 Series, 16 DIs, 24 VDC, NPN, -20 to 60°C operating temperature
45MR-1601-T	Module for the ioThinX 4500 Series, 16 DIs, 24 VDC, NPN, -40 to 75°C operating temperature
45MR-2404	Module for the ioThinX 4500 Series, 4 relays, form A, -20 to 60°C operating temperature
45MR-2404-T	Module for the ioThinX 4500 Series, 4 relays, form A, -40 to 75°C operating temperature
45MR-2600	Module for the ioThinX 4500 Series, 16 DOs, 24 VDC, sink, -20 to 60°C operating temperature
45MR-2600-T	Module for the ioThinX 4500 Series, 16 DOs, 24 VDC, sink, -40 to 75°C operating temperature
45MR-2601	Module for the ioThinX 4500 Series, 16 DOs, 24 VDC, source, -20 to 60°C operating temperature
45MR-2601-T	Module for the ioThinX 4500 Series, 16 DOs, 24 VDC, source, -40 to 75°C operating temperature
45MR-2606	Module for the ioThinX 4500 Series, 8 DIs, 24 VDC, PNP, 8 DOs, 24 VDC, source, -20 to 60°C operating temperature
45MR-2606-T	Module for the ioThinX 4500 Series, 8 DIs, 24 VDC, PNP, 8 DOs, 24 VDC, source, -40 to 75°C operating temperature
45MR-3800	Module for the ioThinX 4500 Series, 8 AIs, 0 to 20 mA/4 to 20 mA, -20 to 60°C operating temperature
45MR-3800-T	Module for the ioThinX 4500 Series, 8 AIs, 0 to 20 mA/4 to 20 mA, -40 to 75°C operating temperature
45MR-3810	Module for the ioThinX 4500 Series, 8 AIs, -10 to 10 V/0 to 10 V, -20 to 60°C operating temperature
45MR-3810-T	Module for the ioThinX 4500 Series, 8 AIs, -10 to 10 V/0 to 10 V, -40 to 75°C operating temperature

45MR-6600	Module for the ioThinX 4500 Series, 6 RTDs, -20 to 60°C operating temperature
45MR-6600-T	Module for the ioThinX 4500 Series, 6 RTDs, -40 to 75°C operating temperature
45MR-6810	Module for the ioThinX 4500 Series, 8 TCs, -20 to 60°C operating temperature
45MR-6810-T	Module for the ioThinX 4500 Series, 8 TCs, -40 to 75°C operating temperature

#### Power Modules

45MR-7820	Module for the ioThinX 4500 Series, potential distributor module, -20 to 60°C operating temperature
45MR-7820-T	Module for the ioThinX 4500 Series, potential distributor module, -40 to 75°C operating temperature

© Moxa Inc. All rights reserved. Updated Nov 12, 2018.

This document and any portion thereof may not be reproduced or used in any manner whatsoever without the express written permission of Moxa Inc. Product specifications subject to change without notice. Visit our website for the most up-to-date product information.