

# A421

## 8MP Face, People and Car Detection Zoom Bullet with D/N, Adaptive IR, Extreme WDR, SLLS, 4.3x Zoom Lens



- Face, People and Car Detection
- 8 Megapixel with 4K Ultra HD
- Day & Night with Superior Low Light Sensitivity and Adaptive IR LED
- 4.3x Zoom Lens with f2.8-12/F1.3, Auto focus (for installation)
- Extreme WDR
- H.265 Compression
- Super wide angle
- Built-in Analytics
- Event trigger, response and notification

### ► Specifications

#### Device

Product Type	Zoom Bullet
Maximum Resolution	8MP
Product Application	Face, People and Car Detection
Application Environment	Outdoor
Image Sensor	Progressive Scan CMOS
Sensor Size	1/2.8 "
Effective Pixels	3864(H) X 2192(V) (8.46 MP)
Day / Night	Yes
Low Light Sensitivity	Superior
Minimum Illumination	Color: 0.03 lux (30 IRE); B/W: 0 lux (IR LED on)
Mechanical IR Cut Filter	Yes
IR LED	Adaptive IR LED
IR Working Distance	40m
Electronic Shutter	1/5-1/64000 second (manual mode); 1/5-1/64000 second (auto mode)
Horizontal Resolution (TV Lines)	2000 TVL

**Lens**

Focal Length	Zoom, f2.8-12mm
Aperture	F1.3
Zoom Ratio	4.3x optical zoom
Zoom Application	Camera Installation
Iris	Adaptive iris
Focus	Auto focus
Lens Mount	Board mount
Horizontal Viewing Angle	103.6° - 31.1°
Vertical Viewing Angle	56.8° - 17.4°

**Video**

Compression	H.265, H.264, MJPEG
Maximum Frame Rate vs. Resolution	30 fps at 3840 x 2160 (4K Ultra HD) 30 fps at 2592 x 1944 30 fps at 2048 x 1536 30 fps at 1920 x 1080 30 fps at 1280 x 960 30 fps at 1280 x 720 30 fps at 800 x 600 30 fps at 720 x 480 30 fps at 640 x 480
Multi-Streaming	Simultaneous triple streams
Bit Rate Mode	Constant, Variable
Wide Dynamic Range	Extreme WDR (130 dB)
Image Enhancement	White Balance, Brightness, Backlight compensation (BLC), Contrast, Saturation, Sharpness, Automatic gain control, Flickerless, Digital Image Stabilizer (DIS, EIS)
Digital Noise Reduction	2D + 3D DNR
Privacy Mask	4 configurable regions
Text Overlay	Yes
On-Screen Graphics	Yes
Built-in Analytics	Deep Learning : Face Detection, People Detection, Car Detection, Tampering Detection, People Line Crossing Detection, People Enter Area Detection, People Exit Area Detection, People Loitering Detection
Image Orientation	Flip, Mirror, Rotation (Corridor mode)

**Audio**

Audio Type	2-way, Mic-in, Line-in, Line-out
Audio Compression	8 kHz, Mono, G.711 u-law

**Network**

Network Protocol & Service	IPv4/v6, TCP, UDP, DHCP, PPPoE, HTTP, HTTPS, DNS, DDNS, NTP, RTP, RTSP, RTCP, SMTP, FTP, IGMP, ICMP, ARP, Bonjour, UPnP, QoS, SNMP, IEEE 802.1X
Ethernet Port	1 x Ethernet (10/100 Base-T), RJ-45 pigtail connector
Security	IP address filtering, HTTPS encryption, Password protected user level, Anonymous login, IEEE 802.1X network access control

**Event**

Event Trigger	Video motion detection (3 regions), External device through digital input, Sound detection, Intelligent event detection, Video streams loss
---------------	---

## Event Response

Notify control center, Change camera settings, Command other devices, E-mail notification with snapshots, Play the audio file, Push notification to mobile device, Save video to local storage, Upload video to NVR server, Upload video or snapshot to FTP server, Activate external device through digital output

**System**

Watchdog	Support
----------	---------

**Integration**

Unified Solution	Fully compatible with ACTi software
GPS Position	Manual setting
Edge Recording	Support (integration with NVR by ONVIF Profile G or proprietary protocol)*
ONVIF Compliant	Yes, Profile S, Profile G, Profile Q, Profile T, Profile M* (To be available through future firmware upgrade)
Web Browser	IE 11, Google Chrome, Microsoft Edge, Apple Safari
Auto Firmware Upgrade	Yes

**Interface**

Audio Interface	1/1, Cable with 3.5mm Phone Jack
Local Storage	MicroSDHC, MicroSDXC Memory Card Slot (card not included, up to 256GB, Kingston or Sandisk only)
Digital Input/Output	1/1 (Cable with Terminal block), DC Output Voltage: 5V
Operating Button	Reset Button

**General**

Power Source	DC 12V, PoE Class 3 (IEEE802.3af)
Power Consumption	12.95 W (PoE)
Weight	1260g (2.78lb)
Dimensions	(W x H x D): 94mm x 80.87mm x 291.16mm (3.70" x 3.18" x 11.46")
Environmental Casing	Weatherproof (IP67), Vandal proof metal casing (IK10)
Starting Temperature	-20°C ~ 50°C (-4°F ~ 122°F)
Operating Temperature	-30°C ~ 50°C (-22°F ~ 122°F)
Approvals	CE Class B, FCC Class B, IP67, IK10 (metal casing)
Color	White
Real-time Clock (RTC)	Yes
Warranty	3 Year(s). For extended warranty offering, see <a href="http://www.acti.com/support/warranty">http://www.acti.com/support/warranty</a>

\* Edge Recording function is integrated with NVR 3 Corporate / NVR 3 Business / INR / GNR series.

## ► Photo Indication



- 1 Audio Output
- 2 DC 12V Power Input
- 3 Factory Reset
- 4 Audio Input
- 5 Ethernet Port
- 6 Digital Input / Output

## ► Dimension Diagram

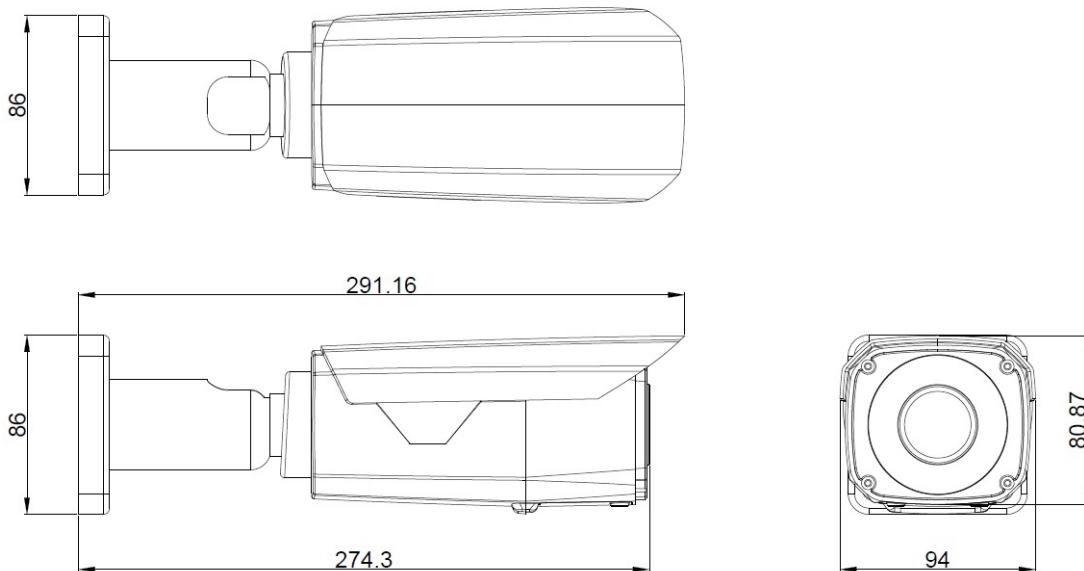

Unit: mm [inch]

## ► Related Products

### Bullet - Bullet



E43B		5MP Bullet with D/N, Adaptive IR, Basic WDR, Vari-focal lens, f2.8-12mm/F1.4 (HOV:69.2°-28.2°), H.264, 1080p/30fps, DNR, Audio, MicroSDHC/MicroSDXC, PoE, IP68, IK10 (metal casing), DI/DO
------	---	--

### Mounting Accessories - Camera Mount

PMAX-0517		Pole Mount (for A44, A45, A46, A48, A413), supports 3.25" to 7.0" Poles
PMAX-0518		Pole Mount (for A44, A45, A46, A48, A413), supports 2" to 3" Poles
PMAX-0524		Pole Mount (for A416, A418, ,A419, A44, A45, A46, A48, VMGB-351, B419-P2), supports 2.64" to 5" Poles
PMAX-0706		Junction Box (for A3x, A4x, E39, E41x, PMAX-0805)

**Note:** Some mounting accessories may need additional accessories for installation. Please check [www.acti.com/mountingselector](http://www.acti.com/mountingselector) for more information.



### Power Supply Accessories - Power Adapter

PPBX-0012		Power Adapter AC 100~240V (US), for A3x, A4x, A88, A9x, Z31, Z8x, Z9x
PPBX-0013		Power Adapter AC 100~240V (EU), for A3x, A4x, A88, A9x, Z31, Z8x, Z9x
PPBX-0014		Power Adapter AC 100~240V (UK), for A3x, A4x, A88, A9x, Z31, Z8x, Z9x

### Power Supply Accessories - PoE Injector

PPOE-0002		PoE Injector IEEE 802.3af compliant, AC 100~240V, with universal connectors
-----------	---	---

### Audio Devices - Microphone

PMIC-0100		Active Microphone Omnidirectional for all Cameras with Line-in Audio
PMIC-0200		Passive Microphone Omnidirectional for all Cameras with Mic-in Audio using 3.5mm Phone Jack