

CW030-Series Power Modules; dc-dc Converters: 36 Vdc to 75 Vdc Inputs; 30 W



The CW030-Series Power Modules use advanced, surface-mount technology and deliver high-quality, compact, dc-dc conversion at an economical price.

Applications

- Distributed power architectures
- Communication equipment
- Computer equipment

* *UL* is a registered trademark of Underwriters Laboratories, Inc.
† *CSA* is a registered trademark of Canadian Standards Association.
‡ *VDE* is a trademark of Verband Deutscher Elektrotechniker e.V.
§ This product is intended for integration into end-use equipment. All the required procedures for CE marking of end-use equipment should be followed. (The CE mark is placed on selected products.)

Description

The CW030-Series Power Modules are dc-dc converters that operate over an input voltage range of 36 Vdc to 75 Vdc and provide precisely regulated outputs. The outputs are isolated from the inputs, allowing versatile polarity configurations and grounding connections. The modules have maximum power ratings of 30 W at a typical full-load efficiency of 83% (81% for the CW030A).

The power modules feature remote on/off, output sense (both negative and positive leads), and output voltage adjustment from 90% to 110% of the nominal output voltage. For disk-drive applications, the CW030B Power Module provides a motor-start surge current of 3 A. The modules are PC board mountable and encapsulated in metal cases. The modules are rated to full load at 100 °C case temperature.

Features

- Small size: 61.0 mm x 71.1 mm x 12.7 mm (2.40 in. x 2.80 in. x 0.50 in.)
- Low output noise
- Constant frequency
- Industry-standard pinout
- Metal case
- 2:1 input voltage range
- Overcurrent and overvoltage protection
- Remote sense
- Remote on/off (positive logic)
- High efficiency: 83% typical
- Adjustable output voltage: 90% to 110% of $V_{O, nom}$
- *UL** 1950 Recognized, *CSA*† C22.2 No. 950-95 Certified, *VDE*‡ 0805 (EN60950, IEC950) Licensed
- CE mark meets 73/23/EEC and 93/68/EEC directives§
- Within FCC Class A Radiated Limits

Options

- Choice of remote on/off logic configuration
- Case ground pin
- Short pins: 2.79 mm ± 0.25 mm (0.110 in. ± 0.010 in.)
- Heat sinks available for extended operation

Absolute Maximum Ratings

Stresses in excess of the absolute maximum ratings can cause permanent damage to the device. These are absolute stress ratings only. Functional operation of the device is not implied at these or any other conditions in excess of those given in the operations sections of the data sheet. Exposure to absolute maximum ratings for extended periods can adversely affect device reliability.

Parameter	Symbol	Min	Max	Unit
Input Voltage (continuous)	V_I	—	80	Vdc
I/O Isolation Voltage:				
Continuous	—	—	500	Vdc
Transient	—	—	1500	V
Operating Case Temperature (See Thermal Considerations section.)	T_C	-40	100	°C
Storage Temperature	T_{stg}	-55	125	°C

Electrical Specifications

Unless otherwise indicated, specifications apply over all operating input voltage, resistive load, and temperature conditions.

Table 1. Input Specifications

Parameter	Symbol	Min	Typ	Max	Unit
Operating Input Voltage	V_I	36	48	75	Vdc
Maximum Input Current ($V_I = 0$ V to 75 V; $I_O = I_{O, max}$; see Figures 1—2.):					
CW030D-M	$I_{I, max}$	—	—	1.0	A
CW030F-M	$I_{I, max}$	—	—	1.1	A
CW030A-M, B-M, C-M	$I_{I, max}$	—	—	1.6	A
Inrush Transient	i^2t	—	—	0.2	A ² s
Input Reflected-ripple Current, Peak-to-peak (5 Hz to 20 MHz, 12 μ H source impedance; $T_C = 25$ °C; see Figure 19 and Design Considerations section.)	I_r	—	25	—	mAp-p
Input Ripple Rejection (120 Hz)	—	—	60	—	dB

Fusing Considerations

CAUTION: This power module is not internally fused. An input line fuse must always be used.

This encapsulated power module can be used in a wide variety of applications, ranging from simple stand-alone operation to an integrated part of a sophisticated power architecture. To preserve maximum flexibility, internal fusing is not included; however, to achieve maximum safety and system protection, always use an input line fuse. The Safety Agencies require a normal-blow fuse with a maximum rating of 5 A in series with the ungrounded input lead. Based on the information provided in this data sheet on inrush energy and maximum dc input current, the same type of fuse with a lower rating can be used. Refer to the fuse manufacturer's data for further information.

Electrical Specifications (continued)

Table 2. Output Specifications

Parameter	Device or Device Suffix	Symbol	Min	Typ	Max	Unit
Output Voltage Set Point ($V_i = 48\text{ V}$; $I_o = I_{o, \text{max}}$; $T_c = 25\text{ }^\circ\text{C}$)	CW030D-M	$V_{o, \text{set}}$	1.94	2.0	2.06	Vdc
	CW030F-M	$V_{o, \text{set}}$	3.20	3.3	3.40	Vdc
	CW030A-M	$V_{o, \text{set}}$	4.90	5.0	5.10	Vdc
	CW030B-M	$V_{o, \text{set}}$	11.76	12.0	12.24	Vdc
	CW030C-M	$V_{o, \text{set}}$	14.70	15.0	15.30	Vdc
Output Voltage (Overall operating input voltage, resistive load, and temperature conditions until end of life. See Figure 21.)	CW030D-M	V_o	1.90	—	2.10	Vdc
	CW030F-M	V_o	3.13	—	3.47	Vdc
	CW030A-M	V_o	4.80	—	5.20	Vdc
	CW030B-M	V_o	11.52	—	12.48	Vdc
	CW030C-M	V_o	14.40	—	15.60	Vdc
Output Regulation: Line ($V_i = 36\text{ V to }75\text{ V}$) Load ($I_o = I_{o, \text{min}}$ to $I_{o, \text{max}}$) Temperature ($T_c = -40\text{ }^\circ\text{C to }+100\text{ }^\circ\text{C}$)	D-M, F-M	—	—	0.02	0.2	% V_o
	A-M, B-M, C-M	—	—	0.01	0.1	% V_o
	All	—	—	0.05	0.2	% V_o
	D-M	—	—	15	30	mV
	F-M	—	—	15	30	mV
	A-M, B-M, C-M	—	—	0.5	1.5	% V_o
Output Ripple and Noise Voltage (See Figure 20.): RMS Peak-to-peak (5 Hz to 20 MHz)	A-M, D-M, F-M	—	—	—	20	mVrms
	B-M, C-M	—	—	—	25	mVrms
	A-M, D-M, F-M	—	—	—	150	mVp-p
	B-M, C-M	—	—	—	200	mVp-p
Output Current (At $I_o < I_{o, \text{min}}$, the modules may exceed output ripple specifications.)	D-M, F-M	I_o	0.6	—	6.5	A
	A-M	I_o	0.6	—	6.0	A
	B-M	I_o	0.3	—	2.5	A
	B-M	$I_{o, \text{trans}}$	—	—	3.0	A
	C-M	I_o	0.2	—	2.0	A
Output Current-limit Inception ($V_o = 90\%$ of $V_{o, \text{nom}}$; see Figures 6—10.)	D-M, F-M	I_o	—	7.5	—	A
	A-M	I_o	—	6.9	—	A
	B-M	I_o	—	3.6	—	A
	C-M	I_o	—	2.5	—	A

Electrical Specifications (continued)

Table 2. Output Specifications (continued)

Parameter	Device or Device Suffix	Symbol	Min	Typ	Max	Unit
Output Short-circuit Current ($V_o = 250$ mV)	A-M, D-M, F-M	—	—	8.0	—	A
	B-M	—	—	4.0	—	A
	C-M	—	—	3.0	—	A
Efficiency ($V_i = 48$ V; $I_o = I_{o, \max}$; $T_c = 25$ °C; see Figures 11—15 and 21.)	CW030D-M	η	65	68	—	%
	CW030F-M	η	72	75	—	%
	CW030A-M	η	79	81	—	%
	CW030B-M, C-M	η	80	83	—	%
Switching Frequency	All	—	—	256	—	kHz
Dynamic Response ($\Delta I_o/\Delta t = 1$ A/10 μ s, $V_i = 48$ V, $T_c = 25$ °C): Load Change from $I_o = 50\%$ to 75% of $I_{o, \max}$ (See Figure 16.): Peak Deviation Setting Time ($V_o < 10\%$ of peak deviation) Load Change from $I_o = 50\%$ to 25% of $I_{o, \max}$ (See Figure 17.): Peak Deviation Setting Time ($V_o < 10\%$ of peak deviation)	All	—	—	2	—	% $V_{o, \text{set}}$
	All	—	—	0.5	—	ms
	All	—	—	2	—	% $V_{o, \text{set}}$
	All	—	—	0.5	—	ms

Table 3. Isolation Specifications

Parameter	Min	Typ	Max	Unit
Isolation Capacitance	—	0.02	—	μ F
Isolation Resistance	10	—	—	M Ω

General Specifications

Parameter	Min	Typ	Max	Unit
Calculated MTBF ($I_o = 80\%$ of $I_{o, \max}$; $T_c = 40$ °C)	3,000,000			hours
Weight	—	—	113 (4.0)	g (oz.)

Feature Specifications

Unless otherwise indicated, specifications apply over all operating input voltage, resistive load, and temperature conditions. See Feature Descriptions and Design Considerations for further information.

Parameter	Device or Device Suffix	Symbol	Min	Typ	Max	Unit
Remote On/Off ($V_I = 36\text{ V to }75\text{ V}$; open collector or equivalent compatible; signal referenced to $V_I(-)$ terminal. See Figure 22 and Feature Descriptions.): CW030x Positive Logic: Logic Low—Module Off Logic High—Module On CW030x1 Negative Logic: Logic Low—Module On Logic High—Module Off Module Specifications: On/Off Current—Logic Low On/Off Voltage: Logic Low Logic High ($I_{on/off} = 0$) Open Collector Switch Specifications: Leakage Current During Logic High ($V_{on/off} = 10\text{ V}$) Output Low Voltage During Logic Low ($I_{on/off} = 1\text{ mA}$) Turn-on Time (@ 80% of $I_{O, max}$; $T_A = 25\text{ }^\circ\text{C}$; V_O within $\pm 1\%$ of steady state; see Figure 18.) Output Voltage Overshoot	All	$I_{on/off}$	—	—	1.0	mA
	All	$V_{on/off}$	-0.7	—	1.2	V
	All	$V_{on/off}$	—	—	6	V
	All	$I_{on/off}$	—	—	50	μA
	All	$V_{on/off}$	—	—	1.2	V
	D-M	—	—	30	90	ms
	A-M, B-M, C-M, F-M	—	—	—	5	ms
	All	—	—	0	5	%
Output Voltage Sense Range	D-M	—	—	—	0.2	V
	F-M	—	—	—	0.3	V
	A-M, B-M, C-M	—	—	—	0.5	V
Output Voltage Set Point Adjustment Range (See Feature Descriptions.)	All	—	90	—	110	% $V_{O, nom}$
Output Overvoltage Protection (clamp)	CW030D-M	$V_{O, clamp}$	2.6	—	4.0	V
	CW030F-M	$V_{O, clamp}$	4.0	—	5.7	V
	CW030A-M	$V_{O, clamp}$	5.6	—	7.0	V
	CW030B-M	$V_{O, clamp}$	13.0	—	16.0	V
	CW030C-M	$V_{O, clamp}$	17.0	—	20.0	V

Characteristic Curves

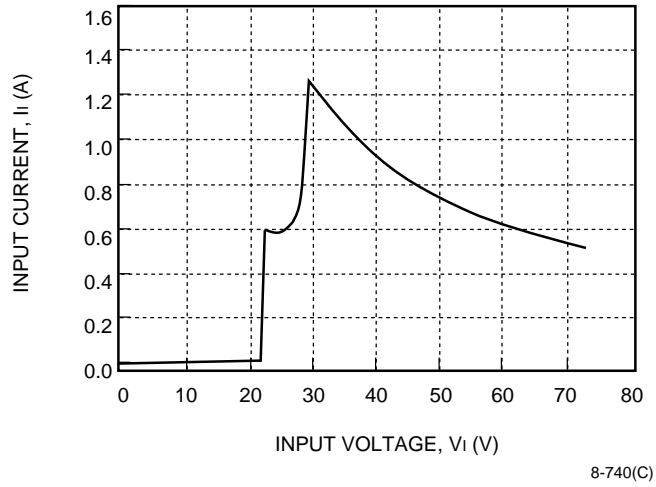

Figure 1. CW030A, B, C Typical Input Characteristics

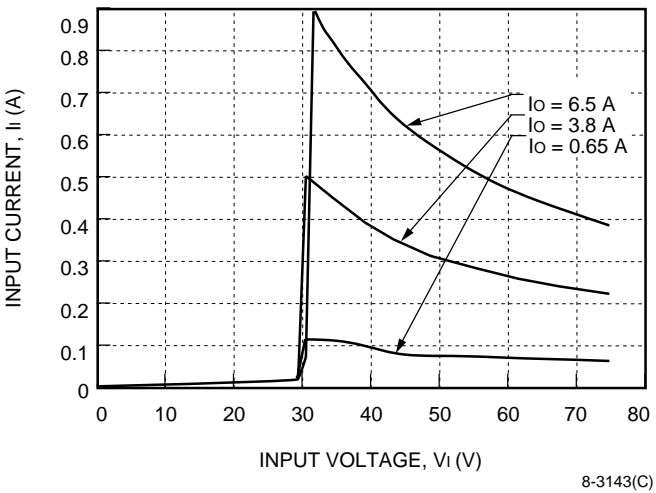

Figure 2. CW030D, F Typical Input Characteristics

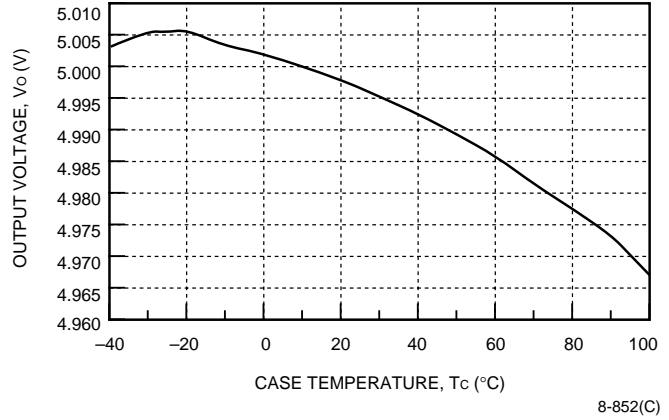

Figure 3. CW030A-M Typical Output Voltage Variation Over Ambient Temperature Range

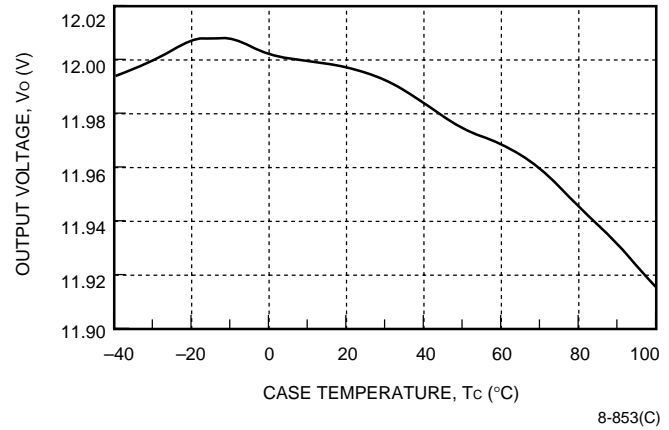

Figure 4. CW030B-M Typical Output Voltage Variation Over Ambient Temperature Range

Characteristic Curves (continued)

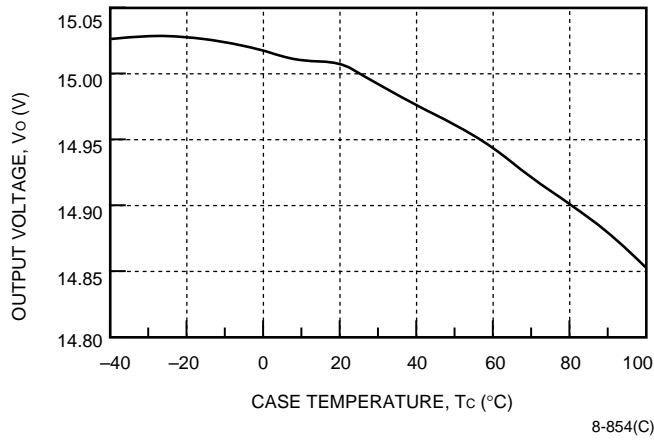

Figure 5. CW030C-M Typical Output Voltage Variation Over Ambient Temperature Range

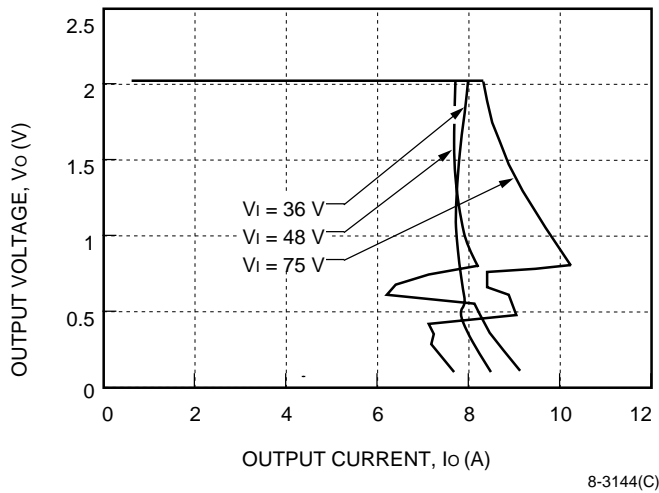

Figure 6. CW030D-M Typical Output Characteristics

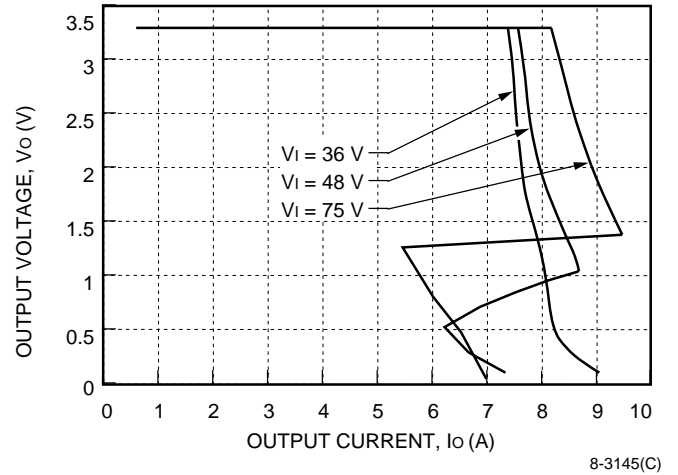

Figure 7. CW030F-M Typical Output Characteristics

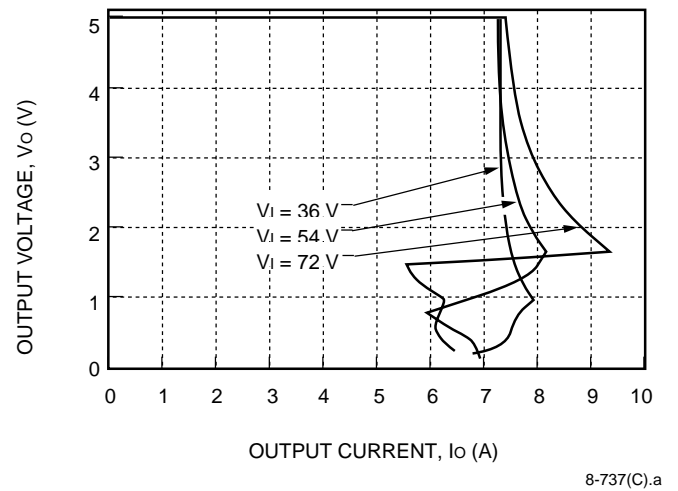
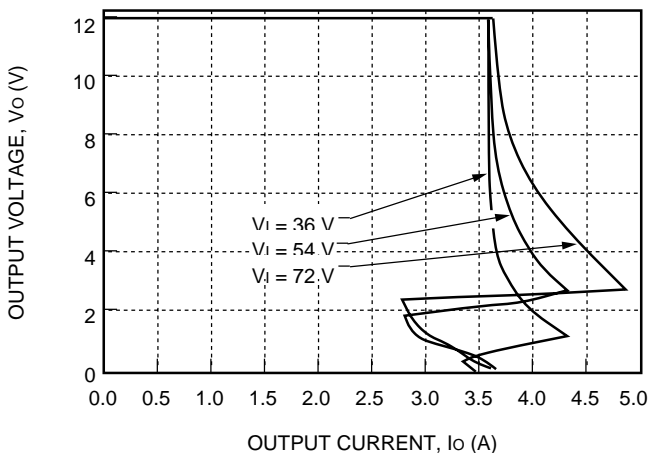

Figure 8. CW030A-M Typical Output Characteristics

Characteristic Curves (continued)



8-738(C).a

Figure 9. CW030B-M Typical Output Characteristics

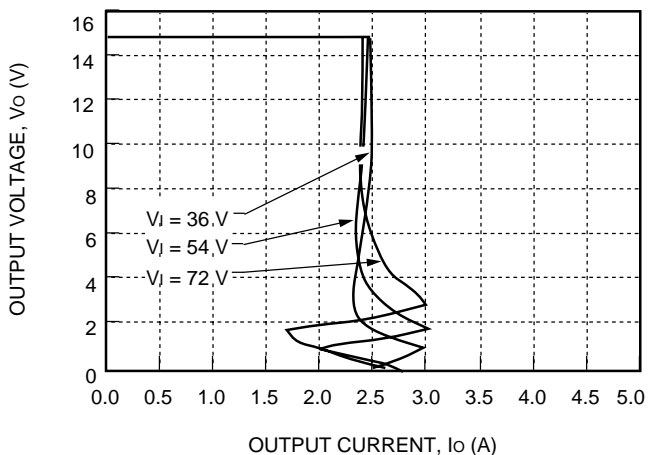

8-739(C).a

Figure 10. CW030C-M Typical Output Characteristics

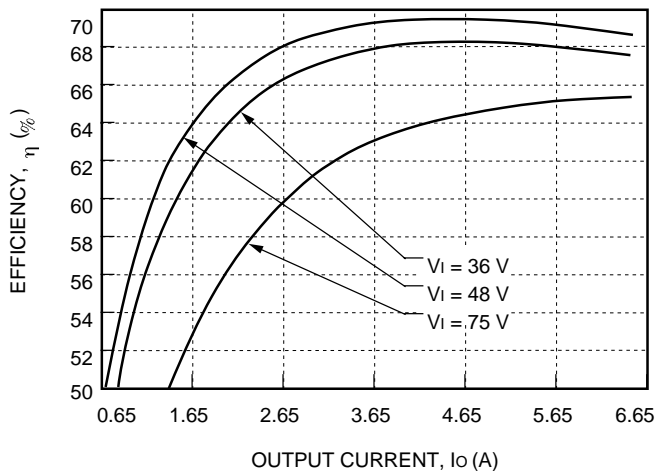

8-3146(C)

Figure 11. CW030D-M Typical Converter Efficiency vs. Output Current

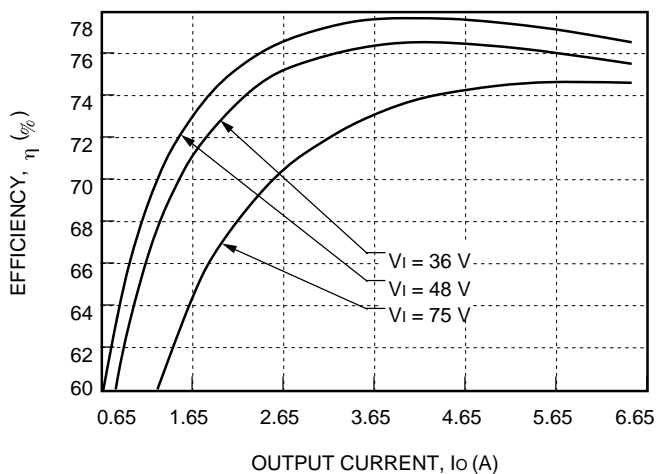

8-3147(C)

Figure 12. CW030F-M Typical Converter Efficiency vs. Output Current

Characteristic Curves (continued)

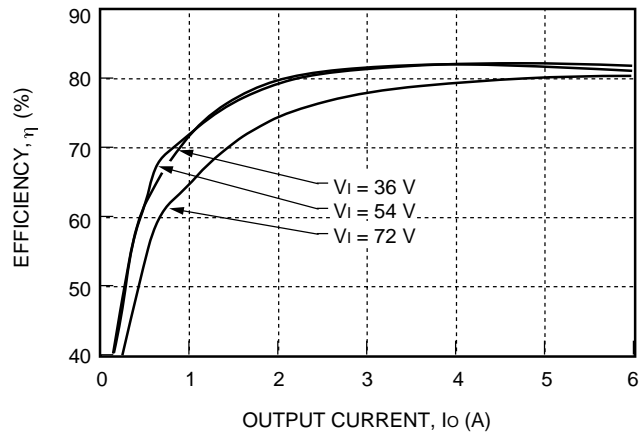

Figure 13. CW030A-M Typical Converter Efficiency vs. Output Current

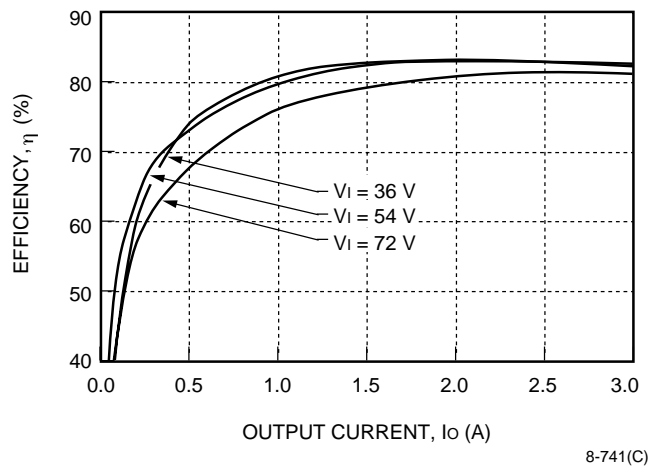

Figure 14. CW030B-M Typical Converter Efficiency vs. Output Current

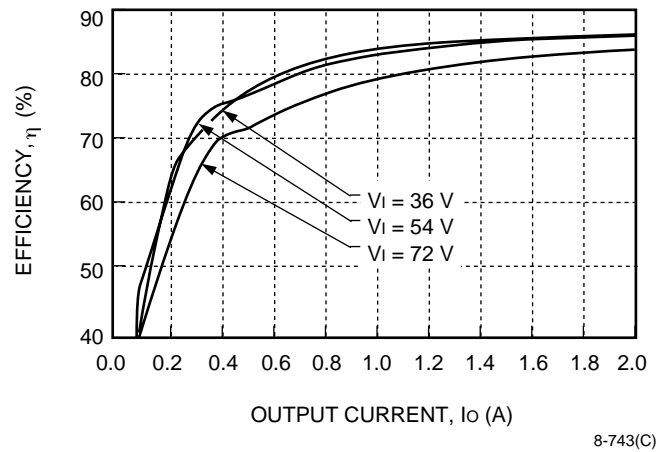

Figure 15. CW030C-M Typical Converter Efficiency vs. Output Current

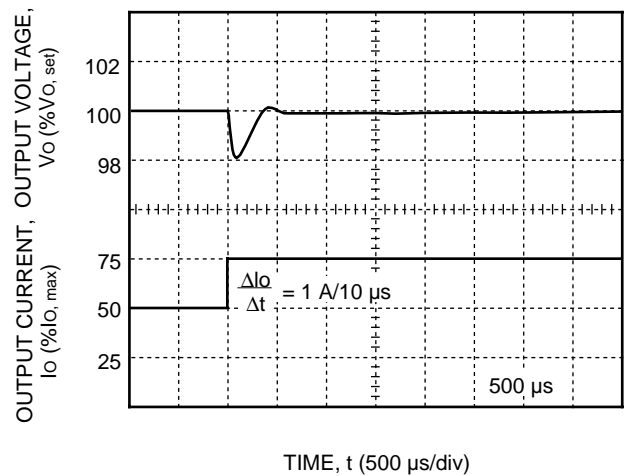
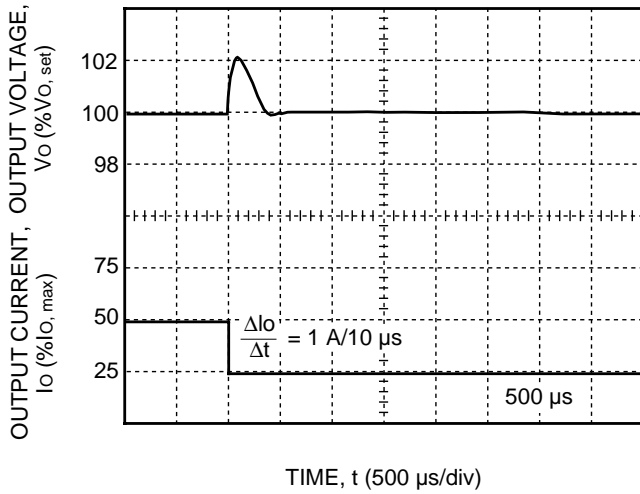

Figure 16. Typical A, B, C, D, F Output Voltage for a Step Load Change from 50% to 75%

Characteristic Curves (continued)



8-732(C).c

Figure 17. Typical A, B, C, D, F Output Voltage for a Step Load Change from 50% to 25%

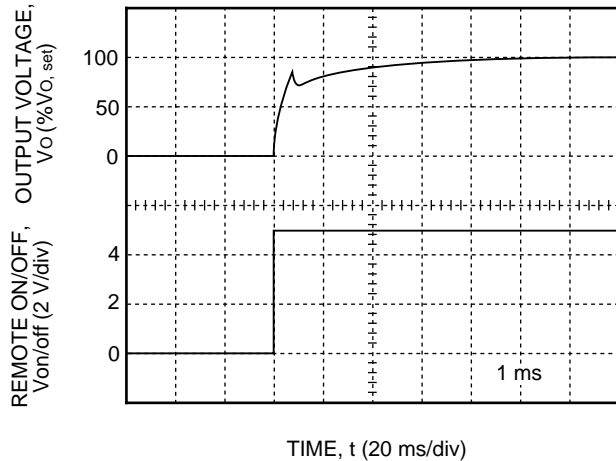

8-733(C).a

Figure 18. Typical A, B, C, D, F Output Voltage Start-Up when Signal Applied to Remote On/Off

Test Configurations

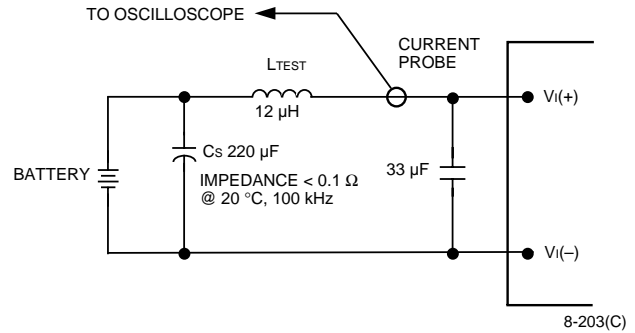

Note: Input reflected-ripple current is measured with a simulated source impedance of 12 μH. Capacitor Cs offsets possible battery impedance. Current is measured at the input of the module.

Figure 19. Input Reflected-Ripple Test Setup

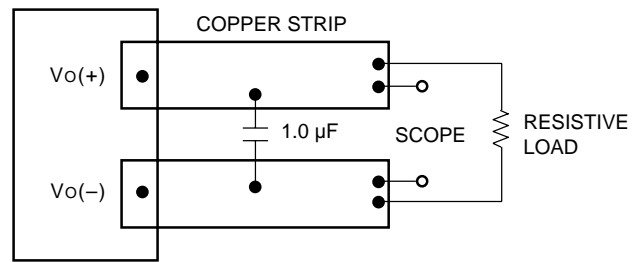

8-513(C).f

Note: Use a 1.0 μF ceramic capacitor. Scope measurement should be made using a BNC socket. Position the load between 50 mm and 75 mm (2 in. and 3 in.) from the module.

Figure 20. Peak-to-Peak Output Noise Measurement Test Setup

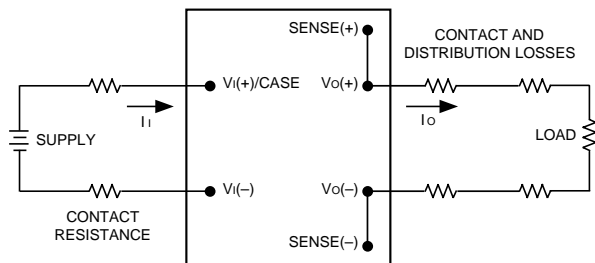

8-749(C).a

Note: All measurements are taken at the module terminals. When socketing, place Kelvin connections at module terminals to avoid measurement errors due to socket contact resistance.

$$\eta = \left(\frac{[V_{O(+)} - V_{O(-)}] I_{O}}{[V_{I(+)} - V_{I(-)}] I_{I}} \right) \times 100 \quad \%$$

Note: Vi(+) is internally connected to case.

Figure 21. Output Voltage and Efficiency Measurement Test Setup

Design Considerations

Grounding Considerations

For modules without the isolated case ground pin option, the case is internally connected to the $V_I(+)$ pin. For modules with the isolated case ground pin option, device code suffix "7," the case is not connected internally allowing the user flexibility in grounding.

Input Source Impedance

The power module should be connected to a low ac-impedance input source. Source inductance greater than 12 μH can affect the stability of the power module. A 33 μF electrolytic capacitor ($\text{ESR} < 0.7 \Omega$ at 100 kHz) mounted close to the power module helps ensure stability of the unit. For other highly inductive source impedances, consult the factory for further application guidelines.

Safety Considerations

For safety-agency approval of the system in which the power module is used, the power module must be installed in compliance with the spacing and separation requirements of the end-use safety agency standard, i.e., *UL* 1950, *CSA* C22.2 No. 950-95, and *VDE* 0805 (EN60950, IEC950).

If the input source is non-SELV (ELV or a hazardous voltage greater than 60 Vdc and less than or equal to 75 Vdc), for the module's output to be considered meeting the requirements of safety extra-low voltage (SELV), all of the following must be true:

- The input source is to be provided with reinforced insulation from any other hazardous voltages, including the ac mains.
- One V_I pin and one V_O pin are to be grounded, or both the input and output pins are to be kept floating.
- The input pins of the module are not operator accessible.
- Another SELV reliability test is conducted on the whole system, as required by the safety agencies, on the combination of supply source and the subject module to verify that under a single fault, hazardous voltages do not appear at the module's output.

Note: Do not ground either of the input pins of the module without grounding one of the output pins. This may allow a non-SELV voltage to appear between the output pins and ground.

The power module has extra-low voltage (ELV) outputs when all inputs are ELV.

The input to these units is to be provided with a maximum 5 A normal-blow fuse in the ungrounded lead.

Feature Descriptions

Overcurrent Protection

To provide protection in a fault (output overload) condition, the unit is equipped with internal current-limiting circuitry and can endure current limiting for an unlimited duration. At the point of current-limit inception, the unit shifts from voltage control to current control. If the output voltage is pulled very low during a severe fault, the current-limit circuit can exhibit either foldback or tailout characteristics (output-current decrease or increase). The unit operates normally once the output current is brought back into its specified range.

Remote On/Off

To turn the power module on and off, the user must supply a switch to control the voltage between the on/off terminal and the $V_I(-)$ terminal ($V_{\text{on/off}}$). The switch can be an open collector or equivalent (see Figure 22). A logic low is $V_{\text{on/off}} = -0.7 \text{ V}$ to 1.2 V. The maximum $I_{\text{on/off}}$ during a logic low is 1 mA. The switch should maintain a logic-low voltage while sinking 1 mA.

During a logic high, the maximum $V_{\text{on/off}}$ generated by the power module is 6 V. The maximum allowable leakage current of the switch at $V_{\text{on/off}} = 6 \text{ V}$ is 50 μA .

Two remote on/off options are available. Positive logic remote on/off turns the module on during a logic-high voltage on the remote ON/OFF pin, and off during a logic low. Negative logic remote on/off turns the module off during a logic high and on during a logic low. Negative logic is specified by a "1" suffix in the device code.

Feature Descriptions (continued)

Remote On/Off (continued)

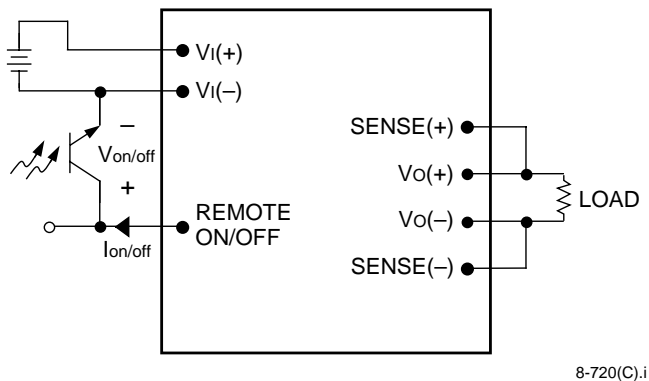

8-720(C).i

Figure 22. Remote On/Off Implementation

Remote Sense

Remote sense minimizes the effects of distribution losses by regulating the voltage at the remote-sense connections. The voltage between the remote-sense pins and the output terminals must not exceed the output voltage sense range given in the Feature Specifications table, for example, for the CW030Bs:

$$[V_{O(+)} - V_{O(-)}] - [SENSE(+)] - SENSE(-)] \leq 0.5 \text{ V}$$

The voltage between the Vo(+) and Vo(-) terminals must not exceed 13.2 V. This limit includes any increase in voltage due to remote-sense compensation, set-point adjustment, and trim (see Figure 23).

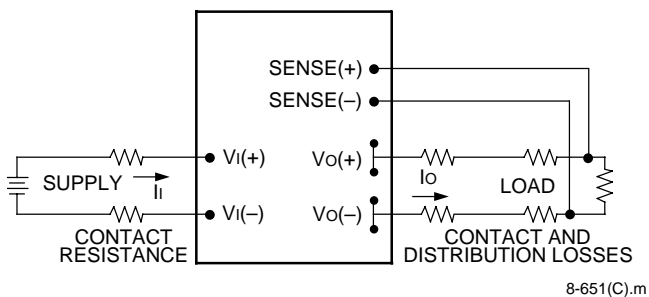

8-651(C).m

Figure 23. Effective Circuit Configuration for Single-Module Remote-Sense Operation

Output Voltage Adjustment

Output voltage adjustment allows the user to increase or decrease the output voltage set point of a module. This is accomplished by connecting an external resistor between the TRIM pin and either the SENSE(+) or SENSE(-) pins (see Figures 24 and 25). With an external resistor between the TRIM and SENSE(-) pins ($R_{\text{adj-up}}$), the output voltage set point ($V_{O, \text{adj}}$) increases.

For CW030D-M, F-M:

$$R_{\text{adj-up}} = \left(\frac{1.235 \times R_1}{V_{O, \text{adj}} - V_{O, \text{nom}}} \right) \text{k}\Omega$$

For CW030A-M, B-M, C-M:

$$R_{\text{adj-up}} = \left(\frac{2.5 \times R_1}{V_{O, \text{adj}} - V_{O, \text{nom}}} \right) \text{k}\Omega$$

The value of the internal resistor R_1 is shown in Table 4.

Table 4. Internal Resistor Values

BMPM Code	R_1
CW030D-M	6.16
CW030F-M	28.47
CW030A-M	16.940
CW030B-M	15.732
CW030C-M	16.670

With an external resistor connected between the TRIM and SENSE(+) pins ($R_{\text{adj-down}}$), the output voltage set point ($V_{O, \text{adj}}$) decreases.

For CW030D-M, F-M:

$$R_{\text{adj-down}} = \left(\frac{(V_{O, \text{adj}} - 1.235) \times R_1}{V_{O, \text{nom}} - V_{O, \text{adj}}} \right) \text{k}\Omega$$

For CW030A-M, B-M, C-M:

$$R_{\text{adj-down}} = \left(\frac{(V_{O, \text{adj}} - 2.5) \times R_1}{V_{O, \text{nom}} - V_{O, \text{adj}}} \right) \text{k}\Omega$$

Feature Descriptions (continued)

Output Voltage Adjustment (continued)

The combination of the output voltage adjustment range and the output voltage sense range given in the Feature Specifications table cannot exceed 110% of the nominal output voltage between the $V_{O(+)}$ and $V_{O(-)}$ terminals.

The CW030 Power Modules have a fixed current-limit set point. Therefore, as the output voltage is adjusted down, the available output power is reduced. In addition, the minimum output current is a function of the output voltage. As the output voltage is adjusted down, the minimum required output current can increase.

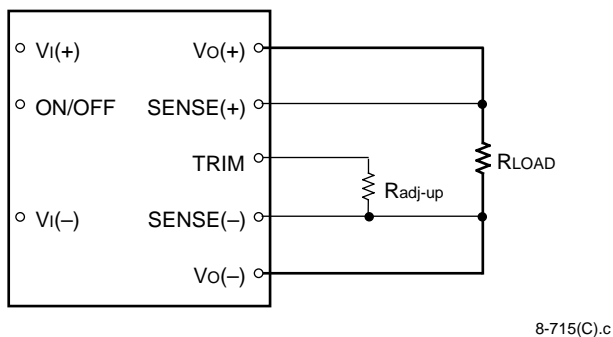

Figure 24. Circuit Configuration to Increase Output Voltage

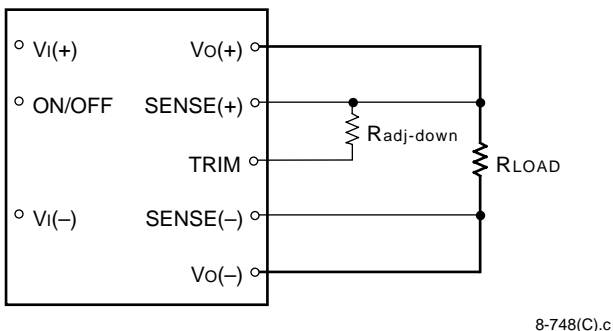

Figure 25. Circuit Configuration to Decrease Output Voltage

Output Overvoltage Protection

The output overvoltage clamp consists of control circuitry, which is independent of the primary regulation loop, that monitors the voltage on the output terminals. The control loop of the clamp has a higher voltage set point than the primary loop (see Feature Specifications table). This provides a redundant voltage control that reduces the risk of output overvoltage.

Thermal Considerations

The CW030-Series Power Modules are designed to operate in a variety of thermal environments. As with any electronic component, sufficient cooling must be provided to help ensure reliable operation. Heat-dissipating components inside the module are thermally coupled to the case to enable heat removal by conduction, convection, and radiation to the surrounding environment.

The thermal data presented is based on measurements taken in a wind tunnel. The test setup shown in Figure 26 was used to collect data for Figures 32 and 33.

The graphs in Figures 27 through 31 provide general guidelines for use. Actual performance can vary depending on the particular application environment. The maximum case temperature of 100 °C must not be exceeded.

Thermal Considerations (continued)

Basic Thermal Performance

The CW030-Series Power Modules are constructed with a specially designed, heat spreading enclosure. As a result, full load operation in natural convection at 50 °C can be achieved without the use of an external heat sink (see Figure 32).

Higher ambient temperatures can be sustained by increasing the airflow or by adding a heat sink. As stated, this data is based on a maximum case temperature of 100 °C and measured in the test configuration of Figure 26.

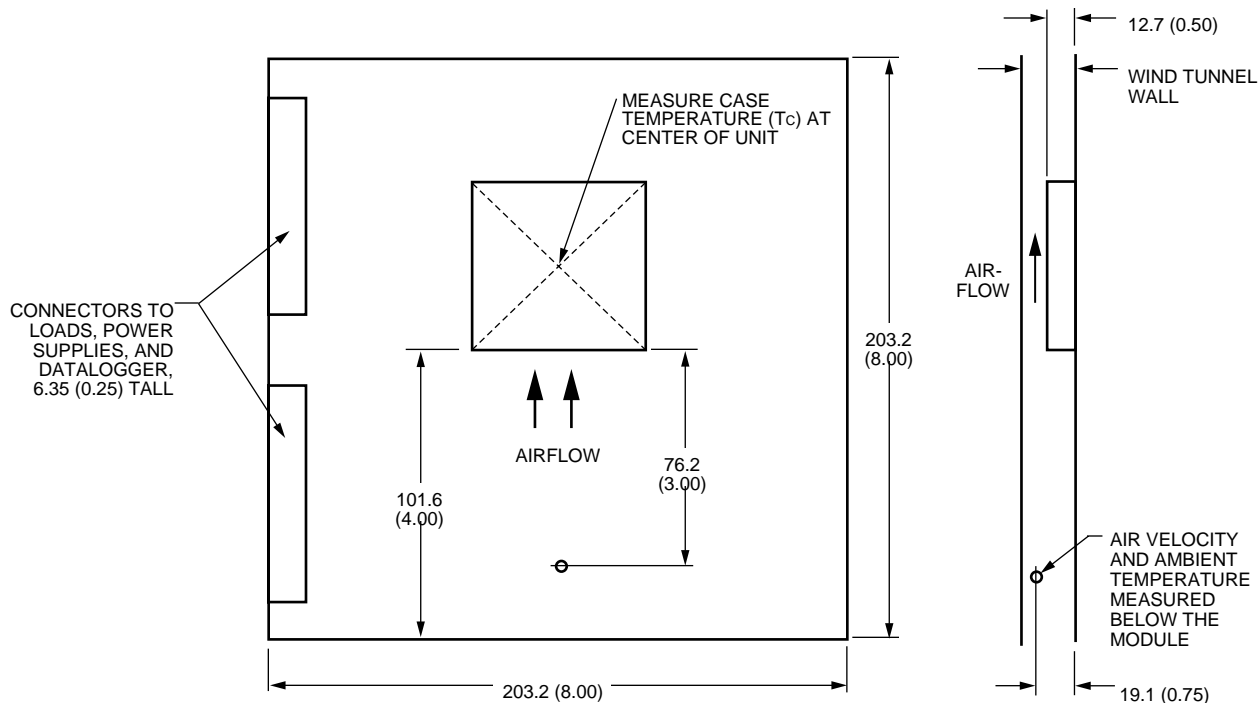

8-1046(C)

Note: Dimensions are in millimeters and (inches).

Figure 26. Thermal Test Setup

Forced Convection Cooling

To determine the necessary airflow, determine the power dissipated by the unit for the particular application. Figures 27 through 31 show typical power dissipation for these power modules over a range of output currents. With the known power dissipation and a given local ambient temperature, the appropriate airflow can be chosen from the derating curves in Figure 32. For example, if the unit dissipates 6.2 W, the minimum airflow in a 80 °C environment is 1.0 ms⁻¹ (200 ft./min).

Thermal Considerations (continued)

Forced Convection Cooling (continued)

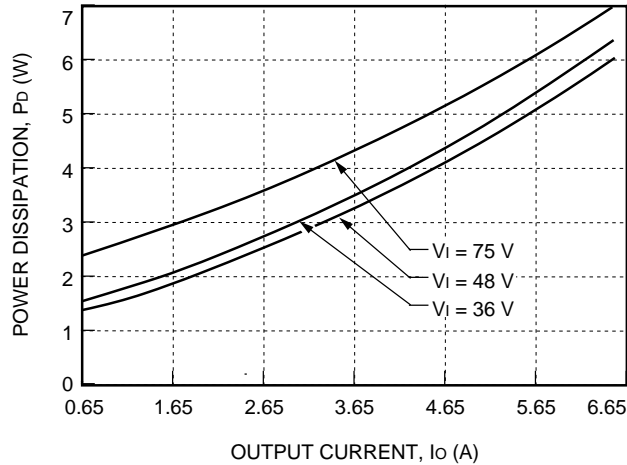

8-3149(C)

Figure 27. CW030D Power Dissipation vs. Output Current

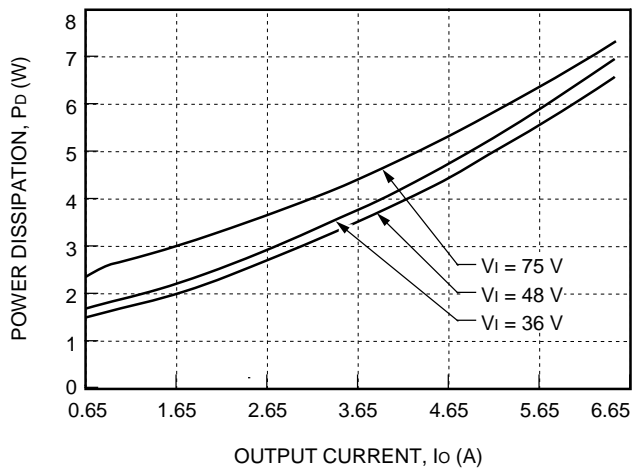

8-3148(C)

Figure 28. CW030F Power Dissipation vs. Output Current

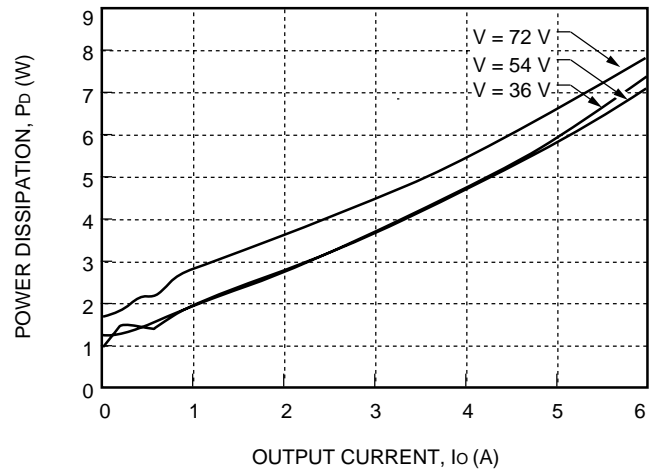

8-1047(C)

Figure 29. CW030A Power Dissipation vs. Output Current

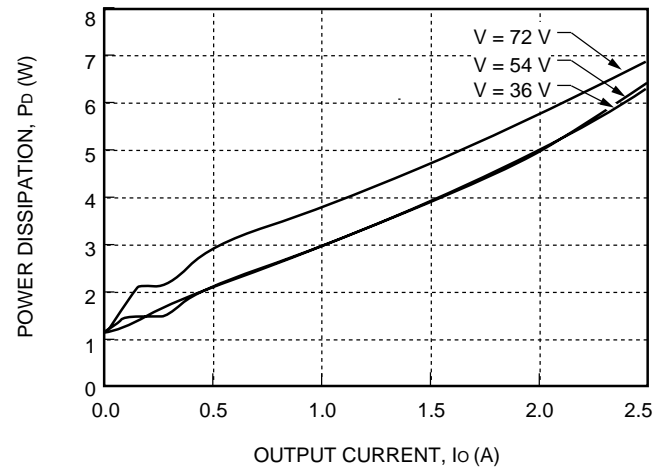

8-1048(C)

Figure 30. CW030B Power Dissipation vs. Output Current

Thermal Considerations (continued)

Forced Convection Cooling (continued)

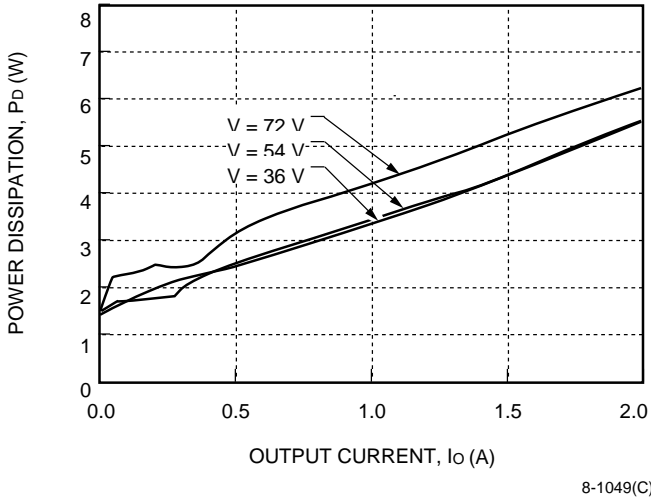

Figure 31. CW030C Power Dissipation vs. Output Current

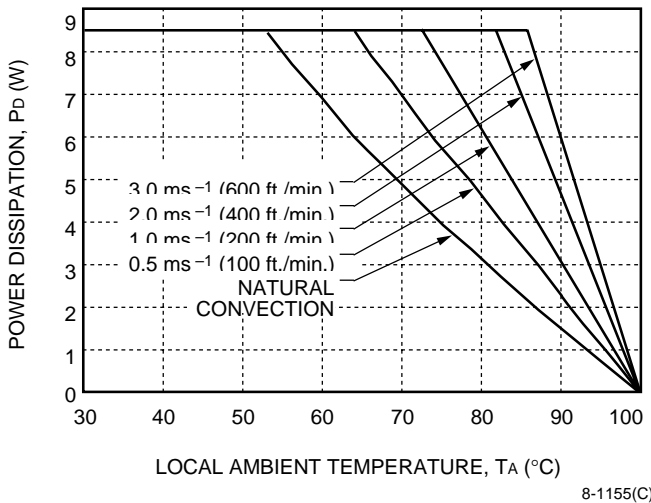

Figure 32. CW030A, B, C, D, F Forced Convection Power Derating with No Heat Sink; Either Orientation

Heat Sink Selection

Several heat sinks are available for these modules. The case includes through threaded mounting holes allowing attachment of heat sinks or cold plates from either side of the module. The module torque must not exceed 0.56 N-m (5 in.-lb.).

Figure 33 shows the case-to-ambient thermal resistant, θ ($^{\circ}\text{C}/\text{W}$), for these modules. These curves can be used to predict which heat sink will be needed for a particular environment. For example, if the unit dissipates 7.1 W of heat in an 80 $^{\circ}\text{C}$ environment with an airflow of 0.5 ms^{-1} (100 ft./min.), the minimum heat sink required can be determined as follows:

$$\theta \leq (T_{C, \text{max}} - T_A) / P_D$$

where:

- θ = module's total thermal resistance
- $T_{C, \text{max}}$ = case temperature (See Figure 26.)
- T_A = inlet ambient temperature (See Figure 26.)
- P_D = power dissipation

$$\theta \leq (100 - 80) / 7.1$$

$$\theta \leq 2.8 \text{ } ^{\circ}\text{C}/\text{W}$$

From Figure 33, the 1/2 in. high heat sink or greater is required.

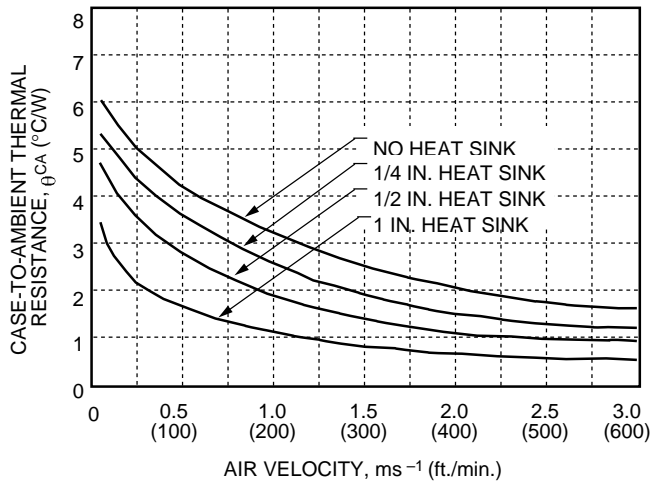

Figure 33. CW030A, B, C, D, F Case-to-Ambient Thermal Resistance vs. Air Velocity Curves; Either Orientation

Thermal Considerations (continued)

Heat Sink Selection (continued)

Although the previous example uses 100 °C as the maximum case temperature, for extremely high reliability applications, one can use a lower temperature for $T_{C, \text{max}}$.

The thermal resistances shown in Figure 33 are for heat transfer from the sides and bottom of the module as well as the top side with the attached heat sink; therefore, the case-to-ambient thermal resistances shown will generally be lower than the resistance of the heat sink by itself. The data in Figure 33 was taken with a thermally conductive dry pad between the case and the heat sink to minimize contact resistance (typically 0.1 °C/W to 0.3 °C/W).

For a more detailed explanation of thermal energy management for this series of power modules as well as more details on available heat sinks, request the technical note: *Thermal Energy Management for CC-, CW-, DC-, and DW-Series 25 W to 30 W Board-Mounted Power Modules*, TN97-015EPS.

Layout Considerations

Copper paths must not be routed beneath the power module standoffs.

Outline Diagram

Dimensions are in millimeters and (inches).

Copper paths must not be routed beneath the power module standoffs.

Tolerances: x.x mm ± 0.5 mm (0.02 in.), x.xx mm ± 0.25 mm (0.010 in.)

Note: For standard modules, V_I(+) is internally connected to case.

Top View

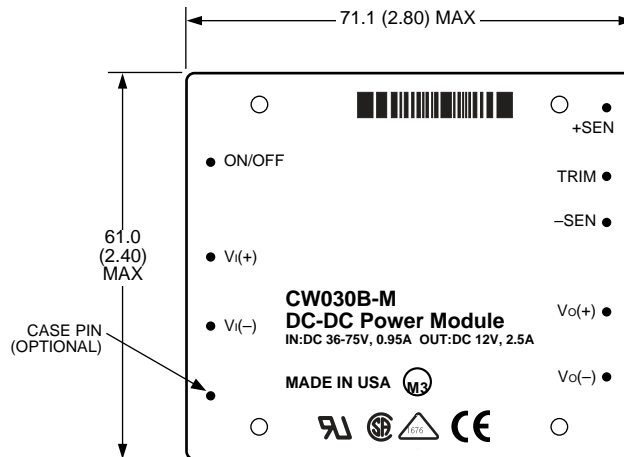

Side View

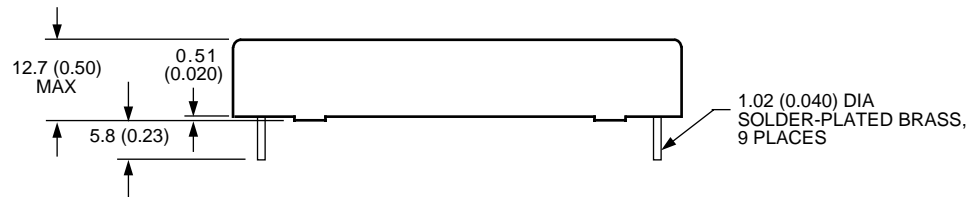

Bottom View

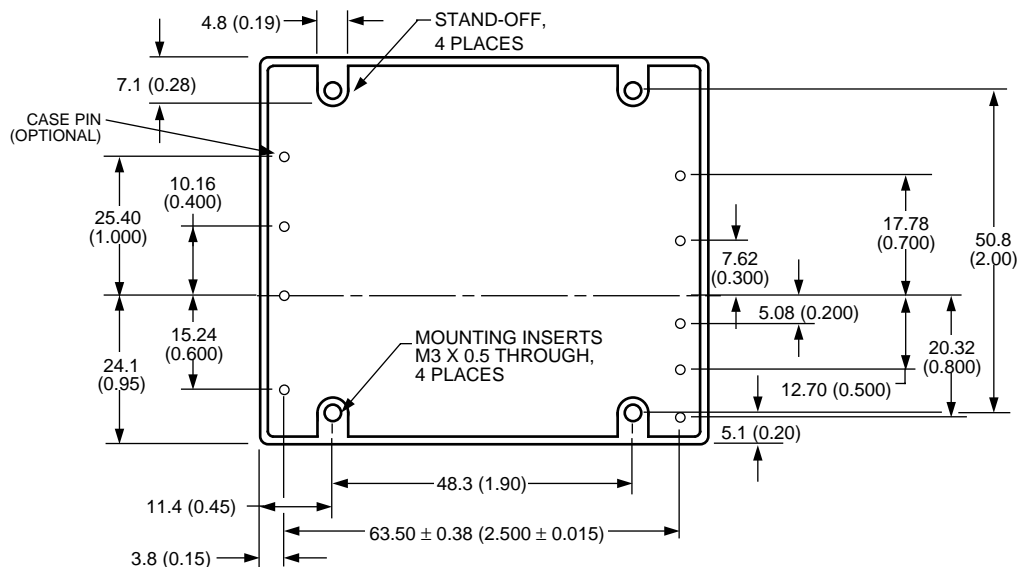

8-751(C).a

8-751(C).a

Recommended Hole Pattern

Component-side footprint.

Dimensions are in millimeters and (inches).

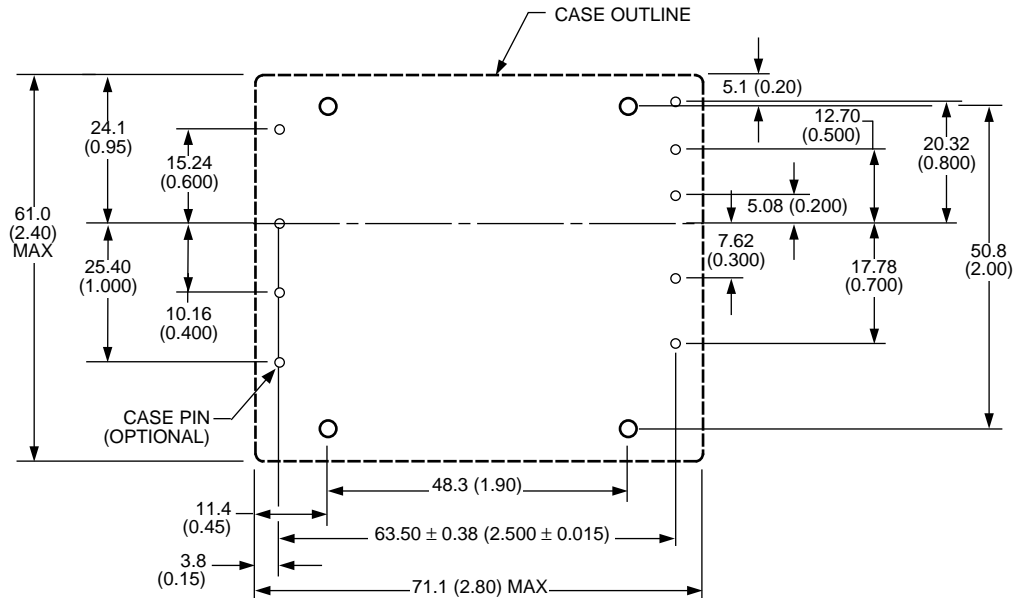

8-751(C).a

Ordering Information

An “-M” suffix denotes M3 x 0.5 heat sink hardware. The heat sinks designed for this package have an “M” prefix, i.e., MHST05045 (see *Thermal Energy Management CC-, CW-, DC-, and DW-Series 25 W to 30 W Board-Mounted Power Modules* Technical Note, TN97-015EPS).

Please contact your Lineage Power Account Manager or Field Application Engineer for pricing and availability.

Table 5. Device Codes

Input Voltage	Output Voltage	Output Power	Device Code	Comcode
48 Vdc	2 Vdc	13 W	CW030D-M	107587289
48 Vdc	3.3 Vdc	21.5 W	CW030F-M	107893299
48 Vdc	5 Vdc	30 W	CW030A-M	107587263
48 Vdc	12 Vdc	30 W	CW030B-M	107584237
48 Vdc	15 Vdc	30 W	CW030C-M	107587271

Optional features may be ordered using the device code suffixes shown below. The feature suffixes are shown in numerically descending order.

Table 6. Device Options

Option	Device Code Suffix
Short pins: 2.79 mm ± 0.25 mm (0.110 in. ± 0.010 in.)	8
Case ground pin	7
Negative remote on/off logic	1



LINEAGE POWER

World Wide Headquarters

Lineage Power Corporation

3000 Skyline Drive, Mesquite, TX 75149, USA

+1-800-526-7819

(Outside U.S.A.: **+1-972-284-2626**)

www.lineagepower.com

e-mail: techsupport1@lineagepower.com

Asia-Pacific Headquarters

Tel: +65 6416 4283

Europe, Middle-East and Africa Headquarters

Tel: +49 89 6089 286

India Headquarters

Tel: +91 80 28411633

Lineage Power reserves the right to make changes to the product(s) or information contained herein without notice. No liability is assumed as a result of their use or application. No rights under any patent accompany the sale of any such product(s) or information.

© 2008 Lineage Power Corporation, (Mesquite, Texas) All International Rights Reserved.