

EN3[®] SERIES WEATHERTIGHT CONNECTORS

NEW PRODUCT BULLETIN 602

SWITCHCRAFT[®]

A H E I C O C O M P A N Y



Please visit www.switchcraft.com for the most up-to-date product specifications. Made in USA.

EN3® SERIES WEATHERTIGHT CONNECTORS

NEW PRODUCT BULLETIN 602



FEATURES & BENEFITS

- Sealed to IP68 NEMA 250 (6P)
- Patented grommet & o-ring free design
- Available in ribbed or winged coupling ring
- Cable, panel & cable to cable options
- Gold plated contacts standard
- Solder, crimp & PC contact options
- Straight & right angle PC contact panel connectors

APPLICATIONS

- Any sealed data transmission
- Military or industrial GPS location devices
- Instrumentation
- Medical data carts
- Marine Applications
- Transportation
- General industrial electronic applications



Please visit www.switchcraft.com for the most up-to-date product specifications. Made in USA.

EN3® SERIES WEATHERTIGHT CONNECTORS

NEW PRODUCT BULLETIN 602

SPECIFICATIONS

MECHANICAL SPECIFICATIONS

Life:	Minimum 600 insertion / withdrawal cycles
Vibration:	Mil-Std 202 Method 201
Shock:	Mil-Std 202 Method 213B, condition K
Hex Nut Torque:	All series hex nut to withstand 8-10 in-lb tightening torque.
Coupling Locking Style	Bayonet with ribbed coupling nut (winged coupling nut optional)
Back Shell Style:	Boot

ELECTRICAL SPECIFICATIONS

Voltage Rating:	250 V AC/DC
Current Rating:	13.0 A – 2 or 3 #16 contacts accepts 16 through 18 AWG 7.5 A – 2 through 6 #20 contacts accepts 20 through 22 AWG 6.5 A – 7 or 8 #20 contacts accepts 20 through 22 AWG 3 A – 9 through 18 #26 contacts accepts 26 through 28 AWG
Insulation Resistance:	100 MΩ min
Contact Resistance:	20 mΩ max

ENVIRONMENTAL SPECIFICATIONS

Operating Temperature Rating:	-40°C to +65°C (-40°F to +149°F)
Moisture Resistance:	Mil-Std 202 Method 106F
Insulation Resistance:	Mil-Std 202 Method 302 condition B
Thermal Shock:	Mil-Std 202 Method 107G
Salt Atmosphere (Corrosion):	Mil-Std 202 Method 101D condition B
Weathertight:	IEC 60529 IP16/IP18 IEC 60529 IP66/IP68 IEC 60529 IP68 NEMA 250 (6P) CFR 46 Part 110.20

MATERIAL SPECIFICATIONS

Panel connector shells & locking disk:	Thermoplastic UL94V-0
Connector shell interior:	Elastomeric, Black UL 94HB
Contacts:	Copper Alloy, Gold over Nickel Plate

MOLDED CABLE ASSEMBLIES

Weathertight:	IEC 60529 IP66/IP68 IEC 60529 IP68 NEMA 250 (6P) CFR 46 Part 110.20
---------------	--

CERTIFICATIONS

UL File E319753 ; 2-8 pin cord, in-line and panel only



Please visit www.switchcraft.com for the most up-to-date product specifications. Made in USA.

EN3® SERIES WEATHERTIGHT CONNECTORS

NEW PRODUCT BULLETIN 602

CORD CONNECTORS

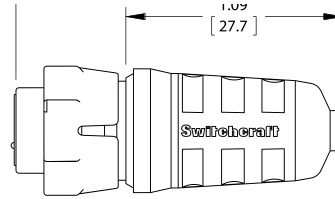
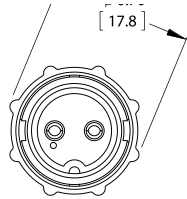

EN3 SERIES 2-18 POSITION
STANDARD
CABLE CLAMP & BOOT

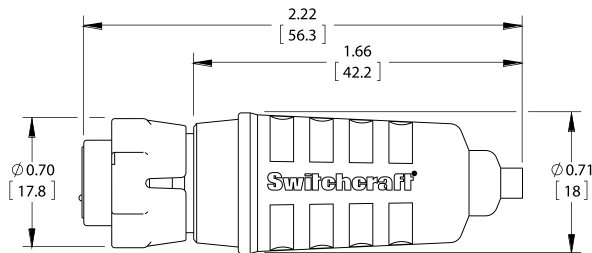

OPTION "L"
EN3 SERIES 2-18 POSITION
LARGE CABLE CLAMP & BOOT

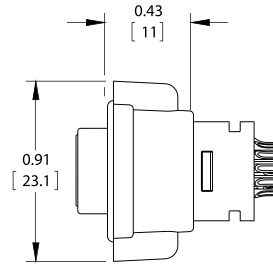

OPTION "W"
EN3 SERIES 2-18 POSITION
WINGED COUPLING RING

CABLE TO CABLE CONNECTORS

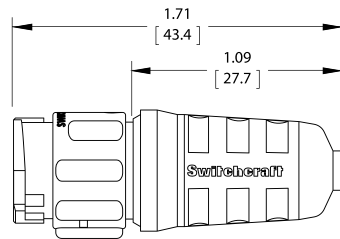
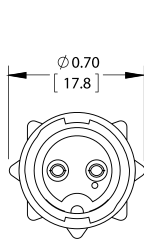

EN3 SERIES 2-18 POSITION
STANDARD
CABLE CLAMP & BOOT
INLINE CONNECTOR

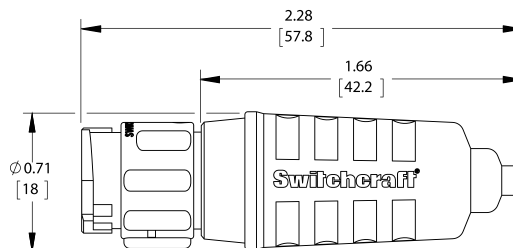

OPTION "L"
EN3 SERIES 2-18 POSITION
LARGE CABLE CLAMP & BOOT
INLINE CONNECTOR

EN3® RIGHT ANGLE 2-8 POSITION MOLDED CONNECTORS

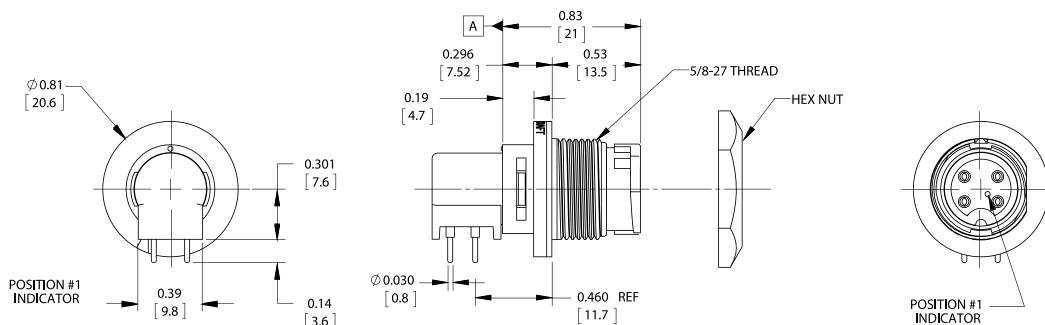

Please visit www.switchcraft.com for the most up-to-date product specifications. Made in USA.

EN3® SERIES WEATHERTIGHT CONNECTORS

NEW PRODUCT BULLETIN 602

PANEL CONNECTORS

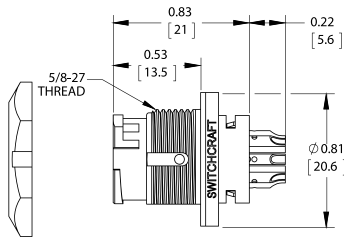

EN3 SERIES 2-8 POSITION
STANDARD SOLDER CUP
ALL POSITIONS FACE RADICALLY OUTWARD
EN3P8MX SHOWN

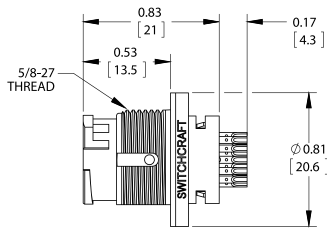

EN3 SERIES 9-18 POSITION
STANDARD SOLDER CUP
ALL POSITIONS FACE UPWARD
EN3P18M26X SHOWN

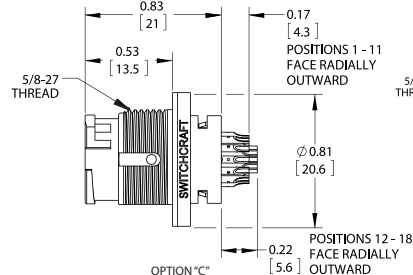

OPTION "C"
EN3 SERIES 2-8 POSITION
CRIMP TERMINALS
EN3P2M26X SHOWN

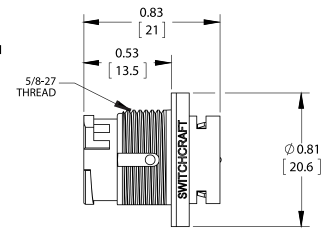

OPTION "S"
EN3 SERIES 9-18 POSITION ONLY
STANDARD SOLDER CUP
EN3P18M26SX SHOWN

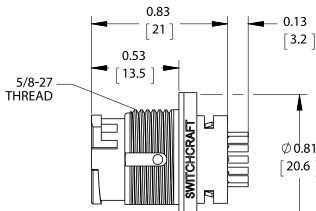

OPTION "C"
EN3 SERIES 9-18 POSITION
CRIMP TERMINALS
EN3P2M26CX SHOWN

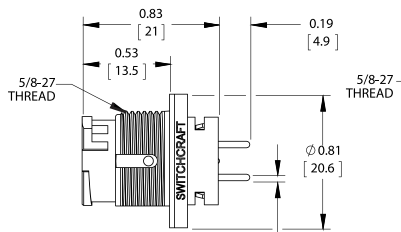

OPTION "P"
EN3 SERIES 2-8 POSITION
PC TERMINALS
EN3P2MPX SHOWN

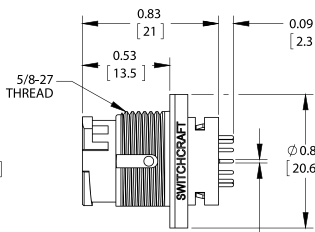

OPTION "P"
EN3 SERIES 9-18 POSITION
PC TERMINALS
EN3P9M26PX SHOWN

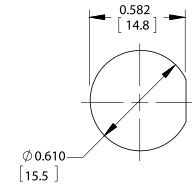

RECOMMENDED PANEL CUT-OUT
0.188 MAX PANEL THICKNESS ± 0.003 [0.08MM]
MOUNTING NUT
8-10 INCH-LBS MAX TORQUE

RIGHT ANGLE PC BOARDS 2-18 CONTACT PANEL CONNECTORS

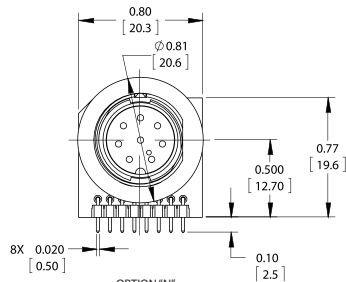

OPTION "N"
EN3 SERIES 2-8 POSITION
NARROW PCB
EN3P8MRAPCBN SHOWN
(NOT AVAILABLE IN FEMALE 7 & 8 POSITION)

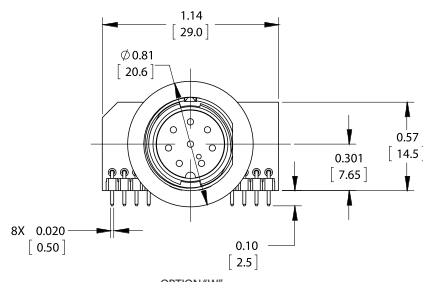

OPTION "W"
EN3 SERIES 2-8 POSITION
WIDE PCB
EN3P8MRAPCBW SHOWN
(NOT AVAILABLE IN FEMALE 7 & 8 POSITION)

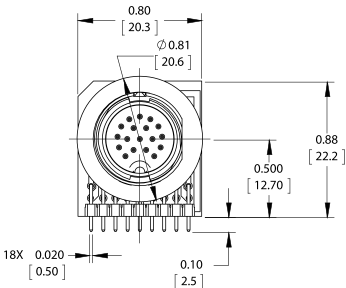
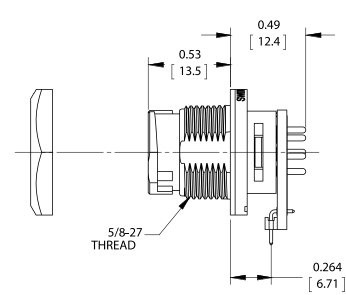

OPTION "N"
EN3 SERIES 9-18 POSITION
NARROW PCB
EN3P18MRAPCBN SHOWN

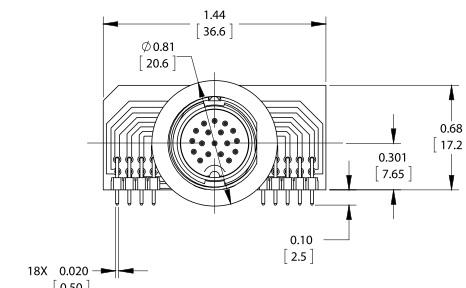

OPTION "W"
EN3 SERIES 9-18 POSITION
WIDE PCB
EN3P18MRAPCBW SHOWN

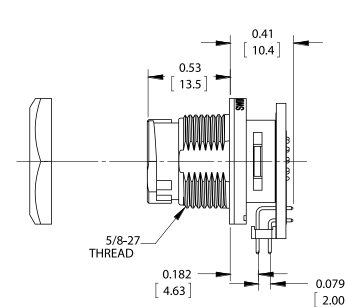

Please visit www.switchcraft.com for the most up-to-date product specifications. Made in USA.

EN3® SERIES WEATHERTIGHT CONNECTORS

NEW PRODUCT BULLETIN 602

EN3® ORDERING CODE

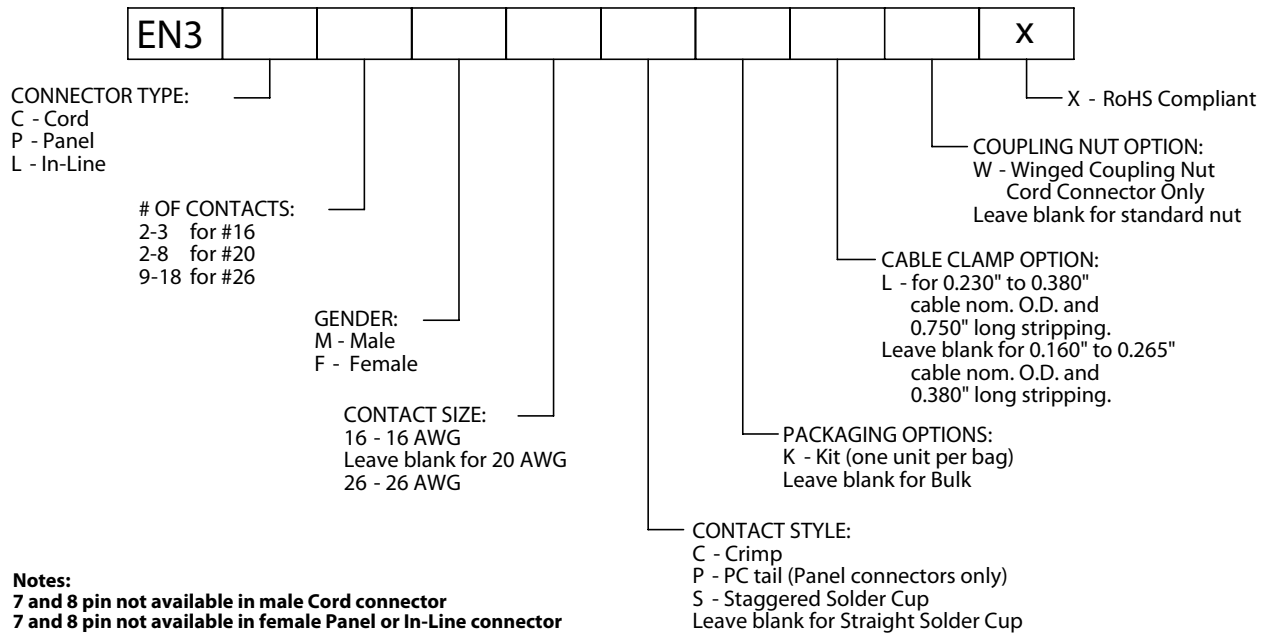

EN3® RIGHT ANGLE PC BOARD MOUNT 2-18 CONTACT ORDERING CODE

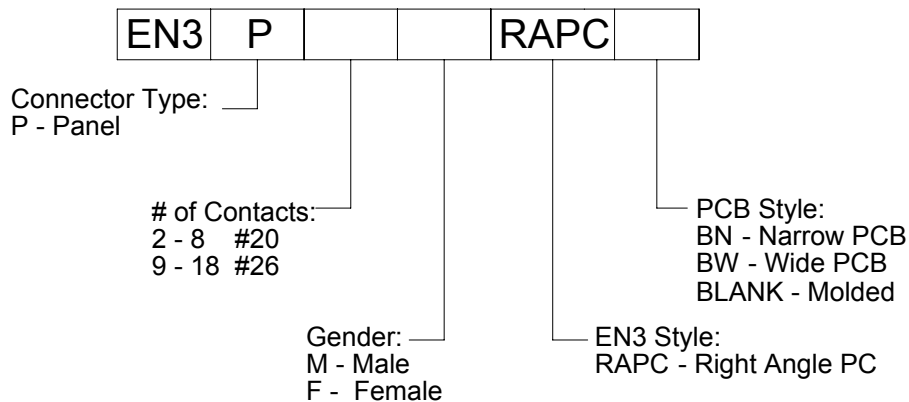

EN3® SERIES ACCESSORIES

EN3 BOOT	EN3 SERIES, REGULAR BOOT FOR CABLE DIAMETERS 0.160"-0.265"
EN3 BOOTL	EN3 SERIES, LARGE BOOT FOR CABLE DIAMETERS 0.230"-0.380"
EN3CAP	EN3 HARSH ENVIRONMENT PANEL OR CABLE END CAP RATED TO IP68, RUBBER LANYARD STYLE
EN3CAPC	CORD PLUG CAP FOR EN3 SERIES
EN3CLAMPX	EN3 HARSH ENVIRONMENT CABLE CLAMP
EN3IPCAPX	EN3 SERIES, IP68 RATED PANEL OR INLINE CAP WITH LOCK RING
EN3NUT	EN3 HARSH ENVIRONMENT HARDWARE-NUT
EN3PQCA	EN3 PANEL ADAPTOR, FOR USE WITH EN3 QUICK CONNECT/ DISCONNECT CABLE ASSEMBLIES



Please visit www.switchcraft.com for the most up-to-date product specifications. Made in USA.