



RN-WIFLY-EVAL-UM

WiFly Evaluation Kit

© 2012 Roving Networks. All rights reserved.
RN-WIFLY-EVAL-UM Version 1.32r 10/9/2012

USER MANUAL

OVERVIEW

This document describes the hardware and software setup for Roving Networks evaluation kits, which contain the hardware you need to evaluate the RN-171 or RN-131 WiFly 802.11 b/g modules. The RN-171 and RN-131 WiFly modules are mounted to evaluation boards. Each board contains status LEDs, connections for the programmer and UART interfaces, a voltage regulator, and easy access to GPIO pins.

You can use the evaluation kits to configure and program the WiFly module using the command interface, create connections, and transfer data. The command interface is made up of simple ASCII commands. See “Resources & Related Documents” on page 13 for information on available documentation.

Evaluation Kit Description

The evaluation kits include the hardware required to connect the evaluation board to your computer. See Table 1 for information on which hardware is provided with each kit. Additionally, Appendix A provides photographs and detailed information on each kit’s contents. To evaluate the module on the evaluation board, you need a computer with a USB port running the Microsoft Windows or Mac OS-X operating system.

NOTE: Before beginning your evaluation, you may need to install the driver for the USB cable. You can download the drivers (as well as other tools and utilities) from the Roving Networks website at <http://www.rovingnetworks.com/support.php>.

Table 1. Evaluation Kit Hardware, Note (1)

Hardware	Description	RN-131-EK	RN-171-EK
Evaluation board	Contains the WiFly module and connectors.	For RN-131 module	For RN-171 module
USB cable	Links your computer to the evaluation board.	✓	✓
Battery pack	Provides power to the evaluation board (requires 2 AA batteries).		✓
PCB trace antenna	Trace antenna included on the PCB.		✓
On-board chip antenna and U.FL.	The PCB includes an on-board chip antenna and a U.FL. connector.	✓	

Notes:

1. See “Appendix A: Legacy Evaluation Kits” on page 14 for more information on evaluation boards that use a serial cable.

Figure 1 shows the RN-131-EK evaluation board and pin information. Table 2 describes the LED indicators.

Figure 1. RN-131-EK Evaluation Board

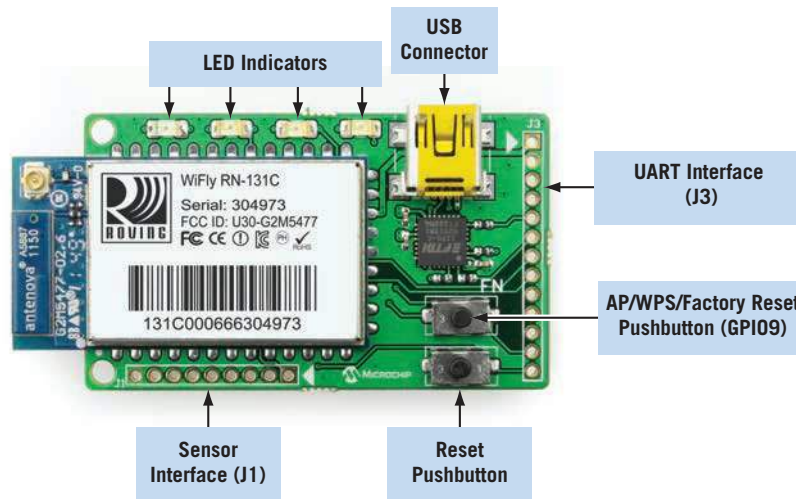

UART Interface (J3)



RX - input to evaluation board
TX - output from evaluation board

Pin	Description
1	3.3 VDC output
2	GND
3	UART RX
4	UART TX
5	UART RTS
6	UART CTS
7	GPIO4
8	GPIO5
9	GPIO6
10	GPIO7
11	GPIO8
12	GPIO9
13	Reset

Sensors (J1)

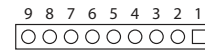

Pin	Description
1	Sensor Power
2	Sensor 4 (3.3-V tolerant)
3	Sensor 5 (3.3-V tolerant)
4	Sensor 7 (1.2 V only)
5	Sensor 5 (1.2 V only)
6	Sensor 4 (1.2 V only)
7	Sensor 6 (1.2 V only)
8	Sensor 3 (1.2 V only)
9	GND

WARNING: Sensors must not have more than 1.2-V DC. Otherwise, the module may be permanently damaged.

Table 2. RN-131-EK Evaluation Board LED Indicators

Condition	Blue LED	Red LED	Yellow LED	Green LED
On solid	Unused	-	-	Connected over TCP
Fast blink	Unused	Not associated	Rx/Tx data transfer	No IP address
Slow blink	Unused	Associated, no Internet	-	IP address OK
Off	Unused	Associated, Internet OK	-	-

Figure 2 shows the RN-171-EK evaluation board and pin information. Table 3 describes the LED indicators.

Figure 2. RN-171-EK Evaluation Board

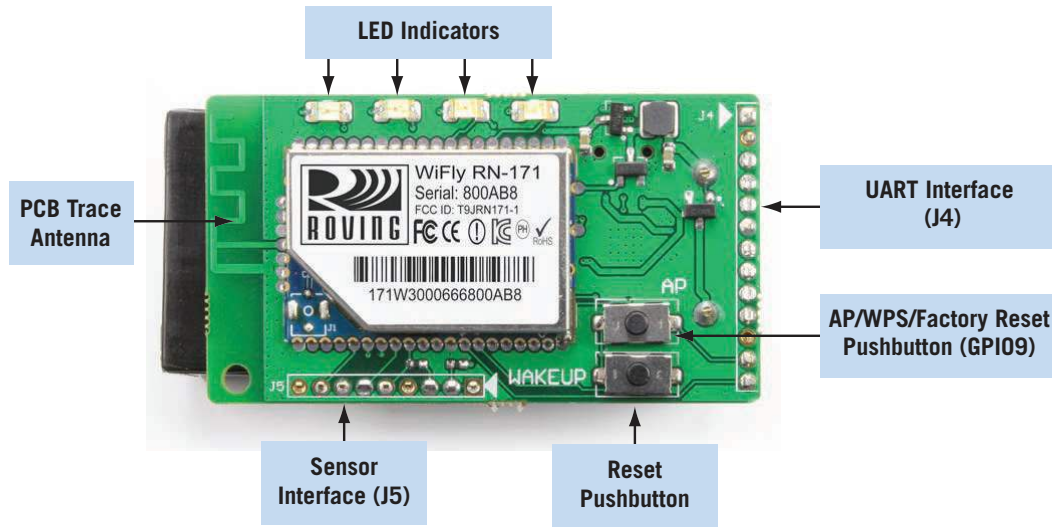

Sensor Interface (J5)

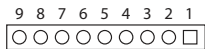

Pin	Description
1	Sensor Power
2	Sensor 4 (3.3-V tolerant)
3	Sensor 5 (3.3-V tolerant)
4	Sensor 7 (1.2 V only)
5	Sensor 5 (1.2 V only)
6	Sensor 4 (1.2 V only)
7	Sensor 6 (1.2 V only)
8	Sensor 3 (1.2 V only)
9	GND

WARNING: Voltage on pins marked 1.2 V Only should not exceed 1.2 V or permanent damage will occur.

Note:

- The RN-171 module drives GPIO8 HIGH on powerup, which overrides software configured powerup values, such as `set sys value 0x0000` on GPIO8.

UART Interface (J4)



RX - input to evaluation board
TX - output from evaluation board

Pin	Description
1	3.3-VDC Output
2	GND
3	UART RX
4	UART TX
5	UART RTS
6	UART CTS
7	GPIO4
8	GPIO5
9	GPIO6
10	GPIO7
11	GPIO8, (1)
12	GPIO9
13	RESET

Table 3. RN-171-EK Evaluation Board LED Indicators

Condition	Blue LED	Red LED	Yellow LED	Green LED
On solid	Not used	-	-	Connected over TCP
Fast blink	Not used	Not associated	Rx/Tx data transfer	No IP address
Slow blink	Not used	Associated, no Internet	-	IP address OK
Off	Not used	Associated, Internet OK	-	-

HARDWARE SETUP

To set up the evaluation hardware, perform the following steps:

- Provide power to the board:
 - RN-131-EK*—The USB cable supplies power to the board.
 - RN-171-EK*—Insert 2 AAA batteries into the battery pack. Alternatively, the USB cable can supply power to the board.
- Connect the USB cable to a USB port on your computer and to the USB connector on the evaluation board. Windows should automatically install the drivers for the cable. If it does not, download and install the FTDI drivers from the Support page on the Roving Networks website at <http://www.rovingnetworks.com/support.php>. Note the COM port to which you have attached the cable.

Figure 3 shows the completed hardware setup for the evaluation boards.

Figure 3. Hardware Setup

RN-131-EK Evaluation Board Hardware Setup



RN-171-EK Evaluation Board Hardware Setup



CONFIGURATION

The WiFly module operates in two modes: data mode (default) and command mode. While in data mode, the WiFly module is essentially a data pipe. When the module receives data over Wi-Fi, it strips the TCP/IP headers and trailers and passes the user data to the UART. When data is written to the UART, the module constructs the TCP/IP packet and sends it out over Wi-Fi. Thus, the entire process of sending/receiving data to the host is transparent to the end microprocessor. See Figure 4.

Figure 4. Data & Command Modes

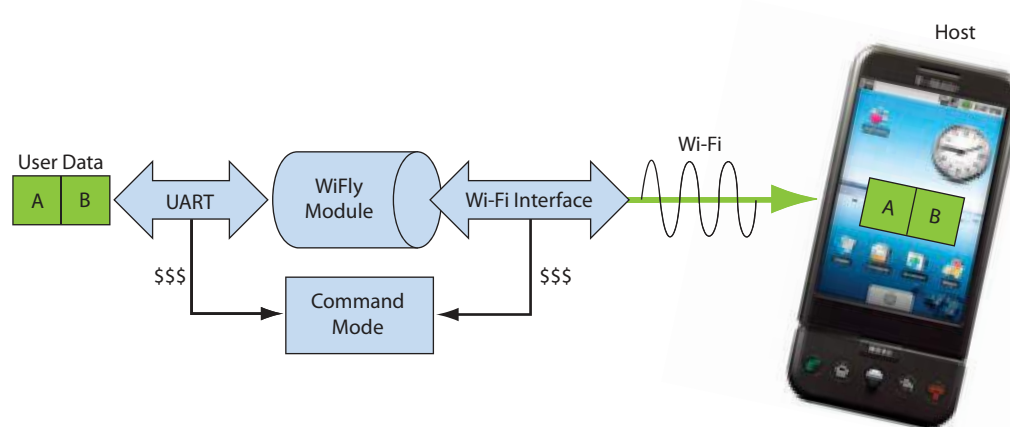

By default, the module is in data mode. Sending the escape sequence **\$\$\$** causes the module to enter command mode. Once in command mode, you can configure the WiFly device using simple ASCII commands. To exit command mode and return to data mode, type **exit <cr>**.

Basic configuration only requires the wireless network access point's name (SSID) and authentication password. The WiFly module can only associate with one network at a time. Roving Networks recommends that you begin your evaluation by configuring the WiFly module using an open access point to simplify the setup.

There are two ways to configure the WiFly module:

- Over the UART, which is connected to a computer or microprocessor
- Via Wi-Fi using ad hoc networking

You need a terminal emulator to complete the setup.

NOTE: Roving Networks suggests using either the TeraTerm (Windows OS) or CoolTerm (Mac OS-X) terminal emulator program.

Configuration Using a Cable

The RN-131-EK and RN-171-EK boards use a USB cable to allow your computer to communicate with the WiFly module on your evaluation board. The following instructions describe how to use a terminal emulator to go into configuration mode, send commands to find networks, associate with an access point, and save your configuration.

Configure the Module Using a Terminal Emulator

To communicate with the module using a terminal emulator, perform the following steps:

1. Determine the COM port that was assigned to the USB cable. If you do not know the COM port number, you can find it using the Windows Device Manager, which is in the system tools. In the Device Manager, browse and expand the selection for Ports (COM & LPT). In the example shown in Figure 5, the port is COM9. For OS-X, if you are using CoolTerm, you can view and select the port from within the application.

NOTE: Legacy evaluation boards use a USB-to-serial cable. If you are using one of these boards, use the COM port to which the USB-to-serial cable is attached.

2. Open your terminal emulation program.
3. Specify the COM port. If you are using TeraTerm, select *Serial* and choose the COM port number from the *Port* drop-down list box.

NOTE: The default serial port setting for the WiFly module is 9600 baud, 8 bits, no parity, and 1 stop bit.

Figure 5. Finding the COM Port Number in Windows

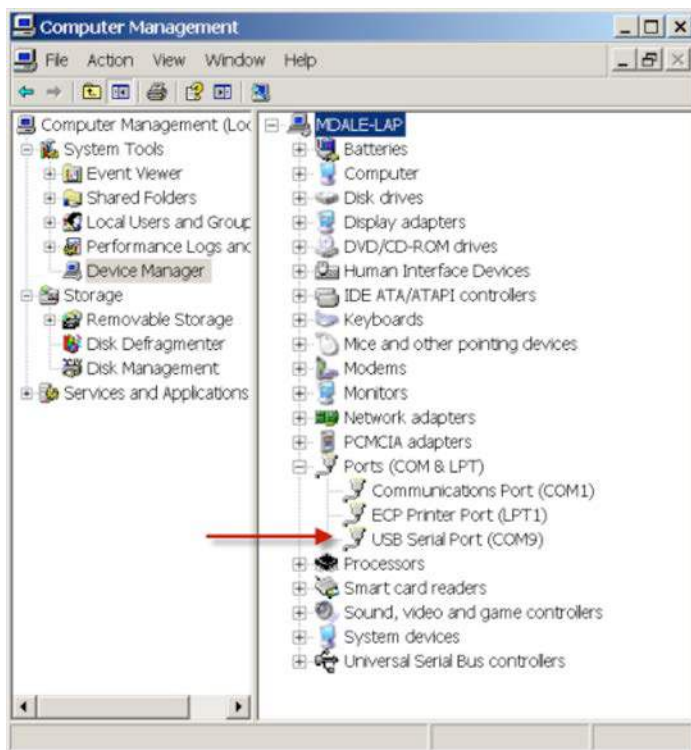

Enter Command Mode

To enter command mode, perform the following steps in the terminal emulator:

1. Type **\$\$\$**. You must type **\$\$\$** together quickly with no additional characters before or after them. The module replies with **CMD** to indicate it is in command mode.
2. Type **show net <cr>** to display the current network settings.

NOTE: When a command completes, the terminal displays a prompt in the format **<X.XX>** where **X.XX** indicates the module's firmware version. In Figure 6, the version is 2.28.

Figure 6. Show Current Network Settings

Example COM Port Setting

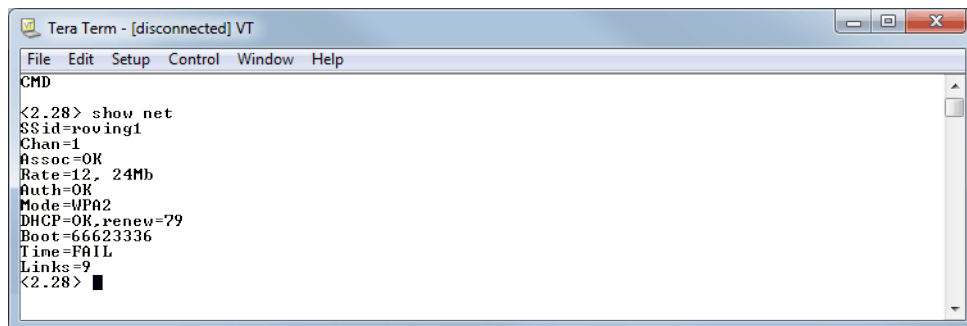

To issue commands to the module, you send a keyword followed by optional parameters. Commands are case sensitive, and you cannot use spaces in parameters. Use a **\$** to indicate a space, e.g., **MY NETWORK** should be written as **MY\$NETWORK**. Additionally, you can use shorthand for the parameters. For example, the following commands are equivalent:

- **set uart baudrate 115200**
- **set uart b 115200**
- **set u b 15200**

NOTE: You cannot use shorthand for command keywords. For example, **s uart baudrate 115200** is illegal.

The WiFly module supports a variety of command keywords. The *Advanced User Manual*, which is available on the Support page of the Roving Networks website, provides a complete command reference. For evaluation purposes, you may view the current settings using the **get** command; **get everything** shows all parameters.

Table 4 shows additional parameters for the **set** and **get** commands.

Table 4. Basic set & get Parameters

Parameter	Function
adhoc	Controls the ad hoc parameters.
broadcast	Controls the broadcast hello/heartbeat UDP message.
comm	Communication and data transfer, matching characters.
dns	DNS host and domain.
ftp	FTP host address and login information.
ip	IP settings.
option	Optional and infrequently used parameters.
sys	System settings, such as sleep and wake timers.
time	Realtime clock settings.
uart	Serial port settings, such as baud rate and parity.
wlan	Wireless interface, such as SSID, channel, and security options.

Find Available Networks

Once you are in command mode, you can instruct the WiFly module to search for available networks. Type **scan** <cr> in the terminal emulator to view a list of Wi-Fi networks within range. See Figure 7.

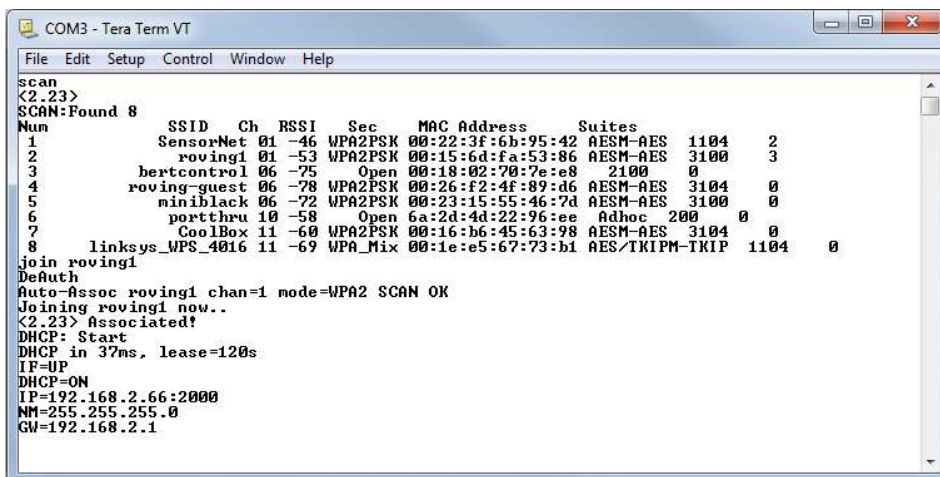
Figure 7. Scan for Networks

```

COM3 - Tera Term VT
File Edit Setup Control Window Help
scan
<2.23>
SCAN:Found 8
Num      SSID      Ch  RSSI  Sec  MAC Address      Suites
1        SensorNet 01 -46 WPA2PSK 00:22:3f:6b:95:42 AESM-AES 1104 2
2        roving1   01 -53 WPA2PSK 00:15:6d:fa:53:86 AESM-AES 3100 3
3        bertcontrol 06 -75 Open 00:18:02:70:7e:e8 2100 0
4        roving-guest 06 -78 WPA2PSK 00:26:f2:4f:89:d6 AESM-AES 3104 0
5        miniblack 06 -72 WPA2PSK 00:23:15:55:46:7d AESM-AES 3100 0
6        portthru  10 -58 Open 6a:2d:4d:22:96:ee Adhoc 200 0
7        CoolBox  11 -60 WPA2PSK 00:16:b6:45:63:98 AESM-AES 3104 0
8        linksys_WPS_4016 11 -69 WPA_Mix 00:1e:e5:67:73:b1 AES/TKIPM-TKIP 1104 0
join roving1
DeAuth
Auto-Assoc roving1 chan=1 mode=WPA2 SCAN OK
Joining roving1 now..
<2.23> Associated!
DHCP: Start
DHCP in 37ms, lease=120s
IP=UP
DHCP=ON
IP=192.168.2.66:2000
NM=255.255.255.0
GW=192.168.2.1
    
```

Associate with an Access Point

You use the **join** keyword to associate with an open access point. As shown in the scan list, **roving1** is an open access point. To associate with an access point, type the following commands (refer back to Figure 7):

```
join roving1
```

```
or
```

```
join # 1
```

To disconnect from a network, type **leave** <cr>. The red LED blinks quickly when the WiFly module is not associated with an access point.

If you want the module to associate with a network automatically upon booting (i.e., persistent configuration), use the **set wlan** command with the SSID name. For example, type:

```
set wlan ssid roving1
save
reboot
```

When the module wakes or power cycles, the module attempts to associate with the network **roving1**.

To associate with a secure network you must also include the network password. The WiFly module determines the security type automatically. In this case, type:

```
set wlan ssid roving1
set wlan pass rubygirl
save
reboot
```

See Figure 8. You can confirm the security settings by typing **get wlan** <cr>.

Figure 8. Connect to a Secure Network

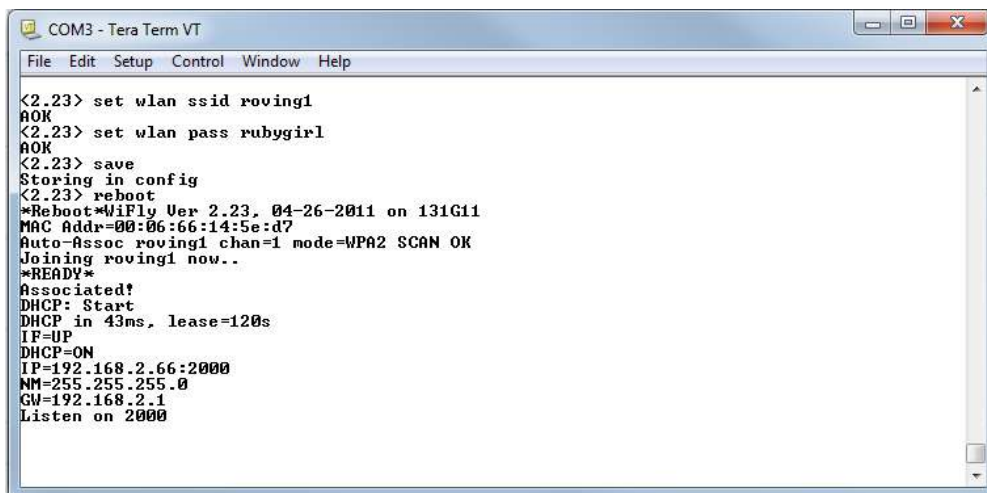

Configuration Using Ad Hoc Mode

You can configure the WiFly module over the air via an ad hoc network. Ad hoc networks are useful for point-to-point communication. In ad hoc mode, the WiFly appears as an access point with which other Wi-Fi devices can associate. You can turn on ad hoc mode using hardware or software configuration.

NOTE: The WiFly module only supports the OPEN mode for ad hoc networks.

Enable Ad Hoc Mode via Hardware

To enable ad hoc mode using hardware, set GPIO9 high (3.3 V) at power up. For the RN-134 board, GPIO9 is on pin 1 on the jumper block (J2). For the RN-174 board, GPIO9 is on the J6 connector. Upon power up with GPIO9 high, the WiFly module creates an ad hoc network with the following settings:

SSID: WiFly-GSX-XX, where XX is the final two bytes of the device's MAC address

IP address: 169.254.1.1

Enable Ad Hoc Mode via Software

To enable ad hoc mode in software, you use the **set wlan** command with the **join**, **ssid**, and **chan** parameters. For example, type the following commands in command mode:

```
set wlan join 4
set wlan ssid my_adhoc_network
set wlan chan 1
```

Set the WiFly module's IP address and netmask. Because automatic IP assignment fixes the first two bytes of the IP address, use 255.255.0.0 as the netmask so that other devices connecting to the module can be reached. You can also set the netmask to a smaller subnet if the other device's IP addresses begin statically at the same subnet as the ad hoc device.

```
set ip address 169.254.1.1
set ip netmask 255.255.0.0
```

Turn off DHCP so that the module does not attempt to obtain an IP address from another device.

```
set ip dhcp 0
```

Save your configuration and reboot. The module will be in ad hoc mode. See Figure 9.

Figure 9. Enable Ad Hoc Network Mode

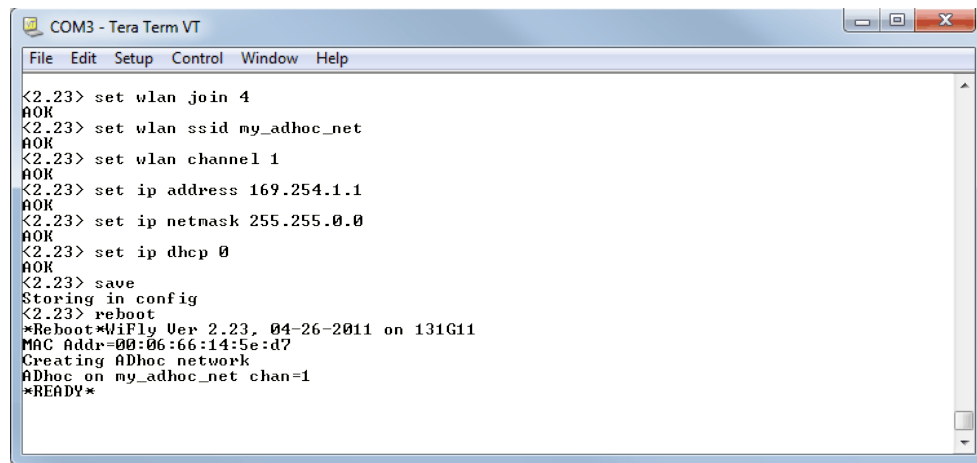

Associate with an Ad Hoc Network

The WiFly module can associate with an ad hoc network created by another device. Type the commands:

```
set wlan ssid my_adhoc_network
save
reboot
```

To associate with an ad hoc network without saving the changes to the module's flash memory, use the **join** command, e.g., **join my_adhoc_network <cr>**.

If DHCP is enabled, the WiFly device obtains an IP address automatically when it associates with the ad hoc network. By definition, auto IP sets the first two bytes of the subnet to 169.254.xxx.xxx. The WiFly device requires 2 to 3 seconds to resolve the IP address.

To set the IP address statically, disable DHCP and explicitly assign the IP address:

```
set ip dhcp 0
set ip address 169.254.1.2
```

You can confirm that the device has properly associated with the ad hoc network using the **ping** keyword:

```
ping 169.254.1.1 10
```

Associate with the WiFly Module over an Ad Hoc Network from a Computer

You can associate with the ad hoc network from a computer by specifying the network name (and password, if required) in the operating system. For example, choose Control Panel > Networking and Sharing > Networking and Sharing Center (Windows Vista) or Control Panel > Network Connections (Windows XP). You can then view available networks and select the name of the WiFly ad hoc network.

NOTE: Once associated with the ad hoc network, Windows Vista may require a few minutes to allocate an IP address. To work around this issue, assign a static IP address under **Network Settings > TCP/IP > Properties**.

Once your computer is associated with the ad hoc network, you can use the WiFly module's IP address to open a connection or connect using telnet as you would with an enterprise connection.

NOTE: The WiFly module does not support ad hoc and infrastructure network modes simultaneously.

Once you have associated with the other network, you can telnet into the WiFly module to configure it. Open the telnet connection using port 2000.

NEXT STEPS

Once you have set up the evaluation kit hardware and have gone through your initial evaluation using the instructions in this user guide, refer to the labs in the *WiFly Training Presentation* to get started developing applications.

RESOURCES & RELATED DOCUMENTS



For more information, refer to the following sources, which are available on the Support page on the Roving Networks website at <http://www.rovingnetworks.com/support.php>:

- *RN-171 Data Sheet*
- *RN-131 Data Sheet*
- *WiFi Command Reference, Advanced Features & Applications User Manual*
- *WiFi Training Presentation*
- Drivers, tools, and utilities

EVALUATION KIT CONTENTS & ORDERING INFORMATION

Table 5 shows the evaluation kit contents and ordering information.

Table 5. Evaluation Kit Contents

Kit Photo	Contents
	<p>RN-131-EK</p> <ul style="list-style-type: none"> • RN-131-EK: Evaluation board for the RN-131 module • USB cable
	<p>RN-171-EK</p> <ul style="list-style-type: none"> • RN-171-EK: Evaluation board for the RN-171 module • USB cable

APPENDIX A: LEGACY EVALUATION KITS

This appendix provides specifications for legacy Roving Networks evaluation kits. Table 6 provides an overview of the kits.

Table 6. Evaluation Kit Hardware

Hardware	Description	RN-131G-EVAL	RN-134-K	RN-174-K
Evaluation board	Contains the WiFly module and connectors.	For RN-131 module	For RN-131 module	For RN-171 module
USB-to-serial cable	Links your computer to the evaluation board. Contains the Prolific chipset.	✓	✓	✓
Null modem	Connects the 10-pin serial cable to the USB-to-serial cable.	✓	✓	✓
10-pin serial cable	Connects from the board's RS-232 header to a DB9 connector.	✓	✓	✓
9-V battery clip	Provides power to the evaluation board (requires a battery).	✓	✓	✓
Antenna cable	U.FL and reverse SMA connectors.	✓		
4" dipole antenna	Reverse SMA connector.	✓		

Figure 10 shows the RN-134 evaluation board and pin information. Table 7 describes the LED indicators.

Figure 10. RN-134 Evaluation Board

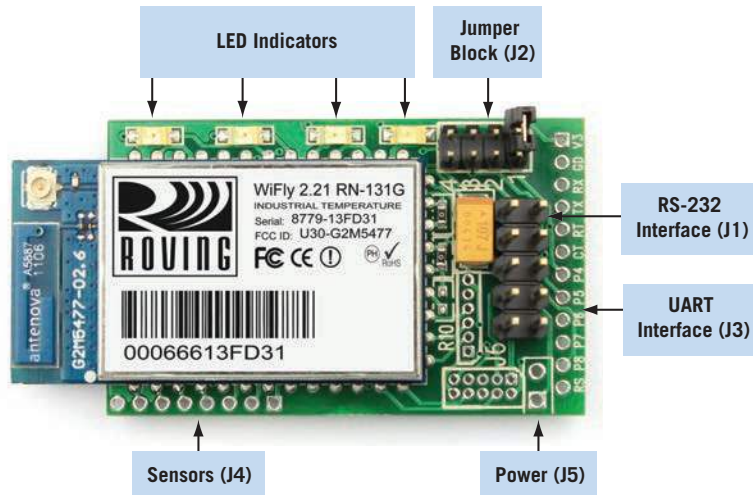
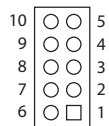

RS-232 Interface (J1)

RX - input to evaluation board
TX - output from evaluation board

Pin	Description
1	No connect
2	RS-232
3	RS-232
4	No connect
5	GND
6	No connect
7	RS-232
8	RS-232
9	5 to 12 VDC input
10	No connect

Power (J5)

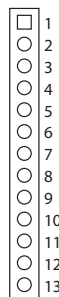

Pin	Description
1	5 to 12 VDC
2	GND

UART Interface (J3)

RX - input to evaluation board
TX - output from evaluation board

Pin	Description
1	3.3 VDC output
2	GND
3	UART RX
4	UART TX
5	UART RTS
6	UART CTS
7	GPIO4
8	GPIO5
9	GPIO6
10	GPIO7
11	GPIO8
12	GPIO9
13	Reset

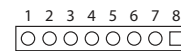
NOTE: The labels on the board for RX and TX are incorrect.

Sensors (J4)

Pin	Description
1	Sensor PWR
2	Resistor network to Sensor 4
3	Resistor network to Sensor 4
4	Sensor 7
5	Sensor 4
6	Sensor 5
7	Sensor 6
8	GND

WARNING: Sensors must not have more than 1.2-V DC. Otherwise, the module may be permanently damaged.

Jumper Block (J2)



Pins	Description
1	Ad hoc mode and factory reset
2	Config 1
3	Config 2
4	Config 3

Table 7. RN-134 Evaluation Board LED Indicators

Condition	Blue LED	Red LED	Yellow LED	Green LED
On solid	Power On	-	-	Connected over TCP
Fast blink	-	Not associated	Rx/Tx data transfer	No IP address
Slow blink	-	Associated, no Internet	-	IP address OK
Off	No Power	Associated, Internet OK	-	-

Figure 11 shows the RN-174 evaluation board and pin information and Table 3 describes the LED indicators.

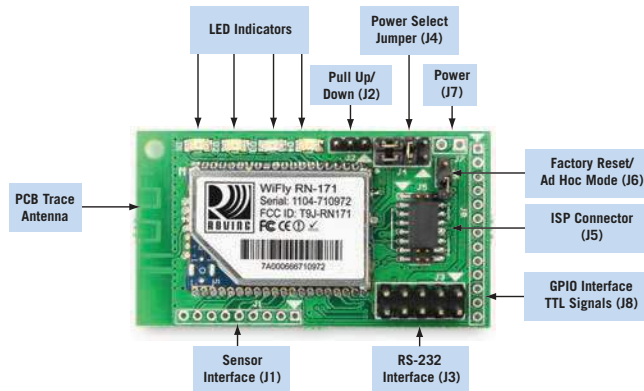
Figure 11. RN-174 Evaluation Board (Part 1 of 2)



RS-232 Interface (J3)

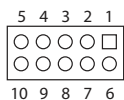

RX - input to evaluation board
TX - output from evaluation board

Pin	Description
1	No connect
2	RS-232 TX
3	RS-232 RX
4	No connect
5	GND
6	No connect
7	RS-232 RTS
8	RS-232 CTS
9	External DC 2 to 3.3 V or 5 to 12 V (see J7)
10	No connect

Power Select Jumper (J4)

High-Voltage Mode (Default). The board is powered by a source up to 12 V DC.

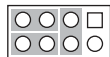

Low-Voltage Mode. The board is powered by 2.0- to 3.3-V DC only.

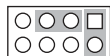

External Power Mode. Used when powering the board with regulated 3.3-V DC power.

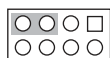

GPIO Interface TTL Signals (J8)



RX - input to evaluation board
TX - output from evaluation board

Pin	Description
1	3.3 VDD
2	GND
3	UART RX
4	UART TX
5	GPIO4
6	GPIO5
7	GPIO6
8	GPIO7
9	GPIO8 (1)
10	GPIO9
11	UART CTS
12	UART RTS
13	RESET

Sensors (J1)

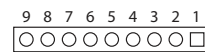

Pin	Description
1	Sensor PWR
2	Sensor 4 (3.3-V tolerant)
3	Sensor 5 (3.3-V tolerant)
4	Sensor 7 (1.2 V only)
5	Sensor 5 (1.2 V only)
6	Sensor 4 (1.2 V only)
7	Sensor 6 (1.2 V only)
8	Sensor 3 (1.2 V only)
9	GND

WARNING: Voltage on pins marked *1.2 V Only* should not exceed 1.2 V or permanent damage will occur.

Power (J7)



Pin	Description
1	External DC 2 to 3.3 V or 5 to 12 V (see J4)
2	GND2

Pull Up/Down (J2)



Ad Hoc Mode/Factory Reset (J6)



Figure 11. RN-174 Evaluation Board (Part 2 of 2)

ISP Connector (J5)

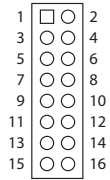

Pin	Description
1	GND
2	3.3 VDD
3	DMA UART TX
4	UART RX
5	FORCE AWAKE
6	RESET
7	DMA UART RX
8	UART TX
9	3.3 VDD
10	GND
11	GPIO9
12	GPIO4
13	GPIO5
14	GPIO6
15	GPIO8
16	Not Used

Note:

- The RN-171 module drives GPIO8 HIGH on powerup, which overrides software configured powerup values, such as **set sys value 0x0000** on GPIO8.

Table 8. RN-174 Evaluation Board LED Indicators

Condition	Blue LED	Red LED	Yellow LED	Green LED
On solid	Not used	-	-	Connected over TCP
Fast blink	Not used	Not associated	Rx/Tx data transfer	No IP address
Slow blink	Not used	Associated, no Internet	-	IP address OK
Off	Not used	Associated, Internet OK	-	-

RN-134 & RN-174 Hardware Setup

To set up the RN-134 and RN-174 evaluation kit hardware, perform the following steps:

1. Provide power to the board by soldering the provided 9-battery clip wire to the board (J7) and attaching a 9-V battery to the clip.
2. Connect the 10-pin serial cable to the evaluation board (J3). When looking at the top of the board, the cable should extend away from the board.

NOTE: If your computer has a DB9 connector, you can connect the 10-pin serial cable directly to it to complete setting up the hardware. The COM port in this case is COM1.

3. Connect the USB-to-serial cable to a USB port on your computer. Windows should automatically install the drivers for the cable. If it does not, download and install the Prolific drivers from the Support page on the Roving Networks website at <http://www.rovingnetworks.com/support.php>. Note the COM port to which you have attached the cable.
4. Connect the USB-to-serial cable to the 10-pin serial cable using the null modem.

Figure 12 shows the completed hardware setup for the RN-134 and RN-174 evaluation boards.

NOTE: By default, the WiFly module uses either the on-board chip antenna (RN-131G-EVAL and RN-134) or the PCB trace antenna (RN-174). If an antenna is included in your kit, you do not need to install it for the evaluation described in this document.

Figure 12. Hardware Setup

RN-134 Evaluation Board Hardware Setup

RN-174 Evaluation Board Hardware Setup



NOTE: Refer to Power (J5) Figure 10 (RN-134) and Power (J7) in Figure 11 (RN-174) for information on where to solder the wires.

Table 9 shows the evaluation kit contents and ordering information.

Table 9. Legacy Evaluation Kit Contents

Kit Photo	Contents
	<p>RN-131G-EVAL Kit</p> <ul style="list-style-type: none"> • RN-134: Evaluation board for RN-131 module • RN-USB-SERIAL: USB-to-serial cable with male DB-9 connector • RN-UFL-SMA-6: U.FI-to-SMA connector cable • RN-SMA-4-RP: 4" reverse antenna with SMA connector • 10-way ribbon cable with male DB-9 termination • Null modem • Battery clip
	<p>RN-134-K Kit</p> <ul style="list-style-type: none"> • RN-134: Evaluation board for RN-131 module • RN-USB-SERIAL: USB-to-serial cable with male DB-9 connector • 10 way ribbon cable with male DB-9 termination • Null modem • Battery clip
	<p>RN-174-K Kit</p> <ul style="list-style-type: none"> • RN-174: Evaluation board for RN-171 module • RN-USB-SERIAL: USB-to-serial cable with male DB-9 connector • 10-way ribbon cable with male DB-9 termination • Null modem • Battery clip

NOTES:

Roving Networks, Inc.
102 Cooper Court
Los Gatos, CA 95032
+1 (408) 395-5300
www.rovingnetworks.com

Copyright © 2012 Roving Networks. All rights reserved. Roving Networks is a registered trademark of Roving Networks. Apple Inc., iPhone, iPad, iTunes, Made for iPhone are registered trademarks of Apple Computer.

Roving Networks reserves the right to make corrections, modifications, and other changes to its products, documentation and services at any time. Customers should obtain the latest relevant information before placing orders and should verify that such information is current and complete.

Roving Networks assumes no liability for applications assistance or customer's product design. Customers are responsible for their products and applications which use Roving Networks components. To minimize customer product risks, customers should provide adequate design and operating safeguards.

Roving Networks products are not authorized for use in safety-critical applications (such as life support) where a failure of the Roving Networks product would reasonably be expected to cause severe personal injury or death, unless officers of the parties have executed an agreement specifically governing such use.