

For board-to-FPC

Narrow pitch connectors (0.4mm pitch)

F4 Series

Compliance with RoHS Directive

FEATURES

1. The lowest profile class among two-piece connectors in the world (Mated height: 0.9mm)

Achieved both a 0.4 mm pitch and an ultra low profile of 0.9 mm high when mated, contributing to further thickness reduction of products.

2. Strong resistance to adverse environments! Utilizes TOUGH CONTACT construction for high contact reliability.

(See Page 6 for details of the structure)

3. Improved mating strength between the socket and header

The simple locking structures provided for the soldering terminals and the contact points improve the mating strength and provide tactile feedback when locked.

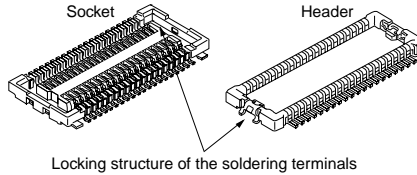

4. Easy to design product circuits

1) An insulating wall provided for the bottom surface of the connector prevents contact between the pattern on the PC board and the metal pins, enabling pattern wiring under the connector, and thus contributing to the reduction in size of PC boards.

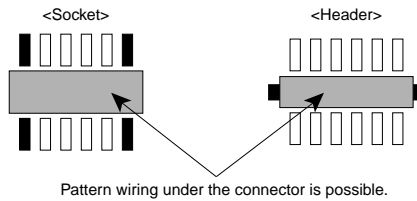

5. Connectors for inspection available
Connectors for inspection are available that are ideal for modular unit inspection and inspection in device assembly processes.

APPLICATIONS

Compact portable devices "Cellular phones, DVD, DSC, etc"

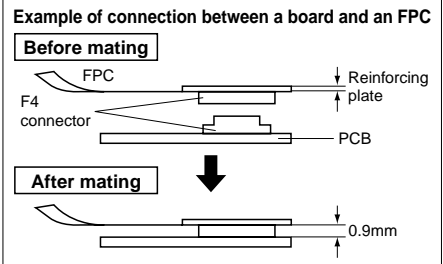

ORDERING INFORMATION

AXK							G
AXK: Narrow Pitch Connector Series							
Series name; 7L: F4 (0.4 mm pitch) Socket 8L: F4 (0.4 mm pitch) Header							
Number of contacts (2 digits)							
Mated height <Socket> 2: For mated height 0.9 mm <Header> 1: For mated height 0.9 mm							
Functions 2: Without positioning bosses							
Surface treatment (Contact portion / Terminal portion) <Socket> 3: Ni plating on base, Au plating on surface (for Ni barrier available) <Header> 4: Ni plating on base, Au plating on surface							
Other specifications <Header> B: Soldering terminals with fork type terminal ^{Note 1}							
Packing G: 3,000 pieces embossed tape and plastic reel × 2							

Notes: 1. "B" in the 11th digit of the header part number signifies a fork type soldering terminals to lessen the constraint on amount of solder when mounting, and a construction that makes it difficult when mounting for excess solder to interfere with the socket. Although compatible with the previous parts, these parts are not compatible with the recommended PC board pattern and recommended metal mask pattern.

PRODUCT TYPES 

Mated height	Number of contacts	Part number		Packing	
		Socket	Header	Inner carton (1 reel)	Outer carton
0.9 mm	10	AXK7L10223G	AXK8L10124BG	3,000 pieces	6,000 pieces (2 reels)
	12	AXK7L12223G	AXK8L12124BG		
	14	AXK7L14223G	AXK8L14124BG		
	16	AXK7L16223G	AXK8L16124BG		
	20	AXK7L20223G	AXK8L20124BG		
	22	AXK7L22223G	AXK8L22124BG		
	24	AXK7L24223G	AXK8L24124BG		
	26	AXK7L26223G	AXK8L26124BG		
	28	AXK7L28223G	AXK8L28124BG		
	30	AXK7L30223G	AXK8L30124BG		
	32	AXK7L32223G	AXK8L32124BG		
	34	AXK7L34223G	AXK8L34124BG		
	36	AXK7L36223G	AXK8L36124BG		
	38	AXK7L38223G	AXK8L38124BG		
	40	AXK7L40223G	AXK8L40124BG		
	44	AXK7L44223G	AXK8L44124BG		
	48	AXK7L48223G	AXK8L48124BG		
	50	AXK7L50223G	AXK8L50124BG		
54	AXK7L54223G	AXK8L54124BG			
60	AXK7L60223G	AXK8L60124BG			
66	AXK7L66223G	AXK8L66124BG			
70	AXK7L70223G	AXK8L70124BG			
80	AXK7L80223G	AXK8L80124BG			

Notes: 1. Regarding ordering units;

During production: Please make orders in 1-reel units.

Samples for mounting confirmation: Available in units of 50 pieces. Please contact us.

Samples: Available. Please contact us.

2. The above part numbers are for connectors without positioning bosses, which are standard. When ordering connectors with positioning bosses, please contact our sales office.

3. Please contact us regarding different number of contacts.

4. "B" in the 11th digit of the header part number signifies a fork type soldering terminals to lessen the constraint on amount of solder when mounting, and a construction that makes it difficult when mounting for excess solder to interfere with the socket.

Although compatible with the previous parts, these parts are not compatible with the recommended PC board pattern and recommended metal mask pattern.

SPECIFICATIONS

1. Characteristics

Item		Specifications	Conditions
Electrical characteristics	Rated current	0.3A/terminal (Max. 5 A at total terminals)	—
	Rated voltage	60V AC/DC	—
	Breakdown voltage	150V AC for 1 min.	Rated voltage is applied for one minute and check for short circuit or damage with a detection current of 1mA
	Insulation resistance	Min. 1,000M Ω (Initial)	Using 250V DC megger (applied for 1 min.)
	Contact resistance	Max. 90m Ω	Based on the contact resistance measurement method specified by JIS C 5402.
Environmental characteristics	Ambient temperature	-55°C to +85°C	No freezing at low temperatures
	Soldering heat resistance	Max. peak temperature of 260°C (on the surface of the PC board around the connector terminals)	Infrared reflow soldering
		300°C within 5 sec, 350°C within 3 sec.	Soldering iron
	Storage temperature	-55°C to +85°C (Product only) -40°C to +50°C (Emboss packing)	No freezing at low temperatures
	Thermal shock resistance (header and socket mated)	5 cycles, insulation resistance min. 100M Ω , contact resistance max. 90m Ω	Sequence 1. -55 $\frac{3}{4}$ °C, 30 min. 2. ~, Max. 5 min. 3. 85 $\frac{3}{4}$ °C, 30 min. 4. ~, Max. 5 min.
	Humidity resistance (header and socket mated)	120 hours, insulation resistance min. 100M Ω , contact resistance max. 90m Ω	Temperature 40 \pm 2°C, humidity 90 to 95% R.H.
	Saltwater spray resistance (header and socket mated)	24 hours, insulation resistance min. 100M Ω , contact resistance max. 90m Ω	Temperature 35 \pm 2°C, saltwater concentration 5 \pm 1%
H ₂ S resistance (header and socket mated)	48 hours, contact resistance max. 90m Ω	Temperature 40 \pm 2°C, gas concentration 3 \pm 1 ppm, humidity 75 to 80% R.H.	
Lifetime characteristics	Insertion and removal life	50 times	Repeated insertion and removal speed of max. 200 times/hours
Unit weight		20 contacts; Socket: 0.03g Header: 0.01g	—

AXK7L, 8L

2. Material and surface treatment

Part name	Material	Surface treatment
Molded portion	LCP resin (UL94V-0)	—
Contact/Post	Copper alloy	Contact portion: Ni plating on base, Au plating on surface Terminal portion: Ni plating on base, Au plating on surface (Except for front edge of terminal) However, the area adjacent to the socket terminal is exposed to Ni on base. Soldering terminals: Socket: Ni plating on base, Pd + Au flash plating on surface (Expect for front edge of terminal) Header: Ni plating on base, Au plating on surface (Expect for front edge of terminal)

DIMENSIONS (unit: mm)

The CAD data of the products with a **CAD Data** mark can be downloaded from: <http://panasonic-electric-works.net/ac>

• Socket (Mated height 0.9 mm)

CAD Data

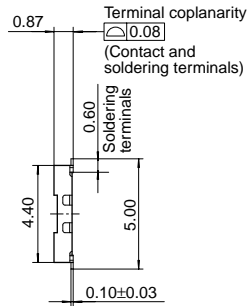
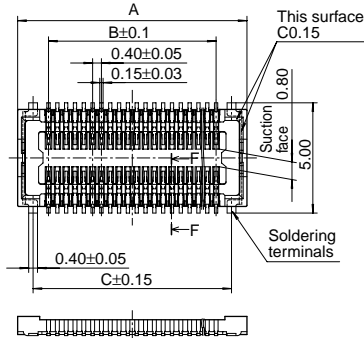

F-F cross section

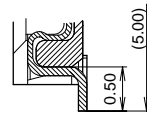

General tolerance: ±0.2

Dimension table (mm)

Number of contacts/ Dimensions	A	B	C
10	4.4	1.6	3.0
12	4.8	2.0	3.4
14	5.2	2.4	3.8
16	5.6	2.8	4.2
20	6.4	3.6	5.0
22	6.8	4.0	5.4
24	7.2	4.4	5.8
26	7.6	4.8	6.2
28	8.0	5.2	6.6
30	8.4	5.6	7.0
32	8.8	6.0	7.4
34	9.2	6.4	7.8
36	9.6	6.8	8.2
38	10.0	7.2	8.6
40	10.4	7.6	9.0
44	11.2	8.4	9.8
48	12.0	9.2	10.6
50	12.4	9.6	11.0
54	13.2	10.4	11.8
60	14.4	11.6	13.0
66	15.6	12.8	14.2
70	16.4	13.6	15.0
80	18.4	15.6	17.0

• Header (Mated height: 0.9 mm)

CAD Data

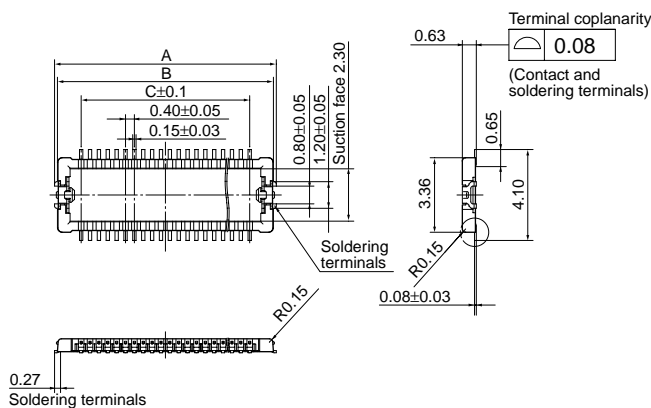

General tolerance: ±0.2

Dimension table (mm)

Number of contacts/ Dimensions	A	B	C
10	4.0	3.74	1.6
12	4.4	4.14	2.0
14	4.8	4.54	2.4
16	5.2	4.94	2.8
20	6.0	5.74	3.6
22	6.4	6.14	4.0
24	6.8	6.54	4.4
26	7.2	6.94	4.8
28	7.6	7.34	5.2
30	8.0	7.74	5.6
32	8.4	8.14	6.0
34	8.8	8.54	6.4
36	9.2	8.94	6.8
38	9.6	9.34	7.2
40	10.0	9.74	7.6
44	10.8	10.54	8.4
48	11.6	11.34	9.2
50	12.0	11.74	9.6
54	12.8	12.54	10.4
60	14.0	13.74	11.6
66	15.2	14.94	12.8
70	16.0	15.74	13.6
80	18.0	17.74	15.6

• Socket and header are mated

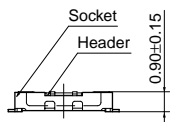

EMBOSSED TAPE DIMENSIONS (unit: mm) (Common for respective contact type, socket and header)

Tape dimensions (Conforming to JIS C 0806-1990. However, some tapes have mounting hole pitches that do not comply with the standard.)

Plastic reel dimensions (Conforming to EIAJ ET-7200B)

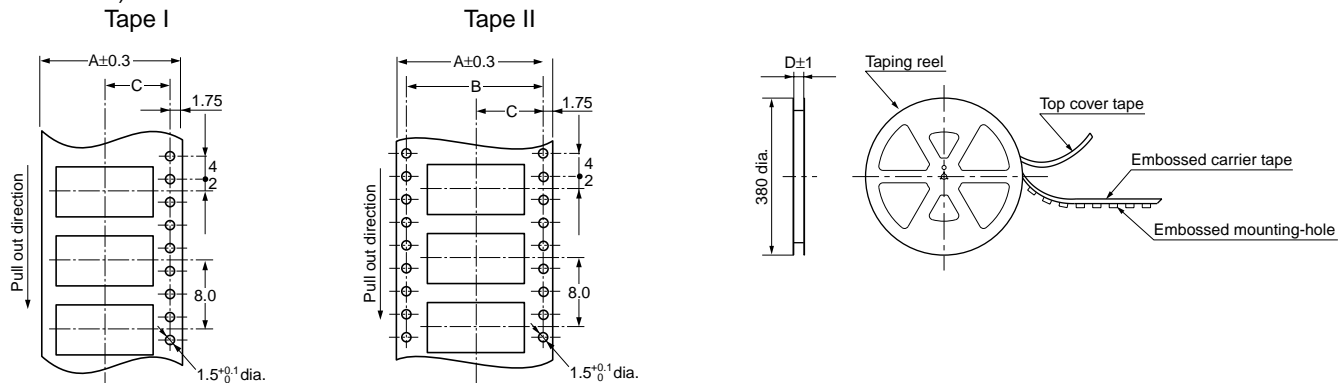
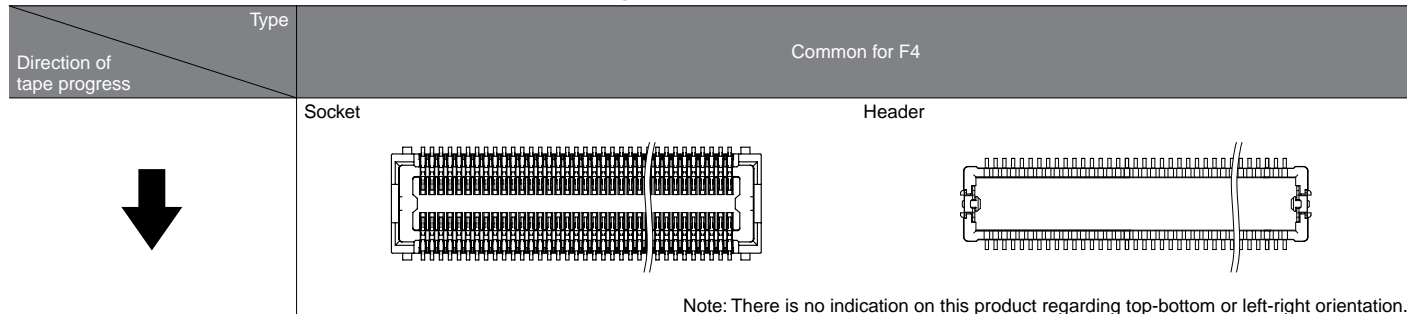

TABLE OF DIMENSIONS

Mated height	Number of contacts	Type of taping	A	B	C	D	Quantity per reel
Common for socket and header: 0.9mm	Max. 24	Tape I	16.0	—	7.5	17.4	3000
	26 to 70	Tape I	24.0	—	11.5	25.4	3000
	80	Tape II	32.0	28.4	14.2	33.4	3000

Connector orientation with respect to direction of progress of embossed tape



Note: There is no indication on this product regarding top-bottom or left-right orientation.

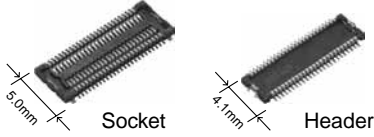

FEATURES

- 3,000 insertion and removals (when as recommended)**
- Same external dimensions and foot pattern as standard type.**
- Improved mating**

Insertion and removal have become easier due to a reduction in the mating retention force required by the simple locking structure and also in the amount of force needed for insertion and removal. (We cannot warrant anything regarding mating retention.)

APPLICATIONS

Ideal for module unit inspection and equipment assembly inspection

TABLE OF PRODUCT TYPES

☆: Available for sale

Product name	Number of contacts																						
	10	12	14	16	20	22	24	26	28	30	32	34	36	38	40	44	48	50	54	60	66	70	80
F4 for inspection	☆	☆	☆	☆	☆	☆	☆	☆	☆	☆	☆	☆	☆	☆	☆	☆	☆	☆	☆	☆	☆	☆	☆

- Notes: 1. Please inquire about numbers of contacts other than those given above.
 2. Please inquire with us regarding delivery times.
 3. Please keep the minimum unit for ordering no less than 50 pieces per lot.
 4. Please inquire for further information.

PRODUCT TYPES

Specifications		Part No.	Specifications		Part No.
Socket	Without positioning bosses	AXK7LE**26G	Header	Without positioning bosses	AXK8LE**26BG

- Notes: 1. When placing an order, substitute the "*" (asterisk) in the above part number with the number of contacts for the required connector.
 2. The above part numbers are for connectors without positioning bosses, which are standard. When ordering connectors with positioning bosses, please contact our sales office.

NOTES

1. Removal by pulling up from an end causes the entire connector removal force to concentrate on the soldering terminals and end terminals.

Therefore, please lift and remove from the side. Doing so will also prevent cracking of the soldered parts.

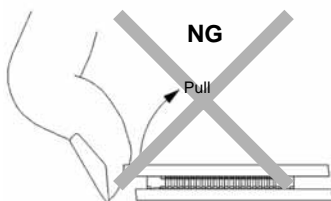
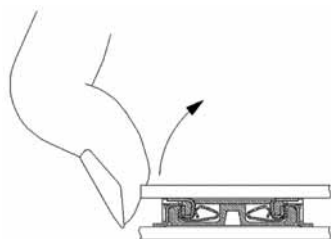

2. PC Boards and Recommended Metal Mask Patterns

Connectors are mounted with high density, with a pitch interval of 0.4 to 0.5 mm.

In order to reduce solder bridge and other issues make sure the proper levels of solder are used.

The figures to the right are recommended metal mask patterns. Please use them as a reference.

In particular, if a lot of solder is used in the header retaining soldering terminals, it might interfere with and cause incomplete socket mating. Therefore, please follow the recommended conditions give on the right.

Socket

Recommended PC board pattern
(Mount pad arrangement pattern)

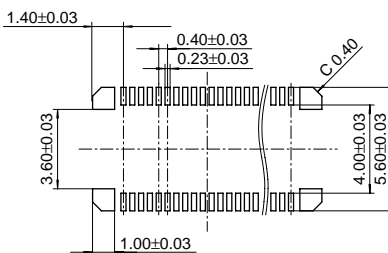

Recommended metal mask pattern

Metal mask thickness: Here, 150 μm
(Terminal portion opening area ratio: 53 %)
(Metal portion opening area ratio: 100 %)

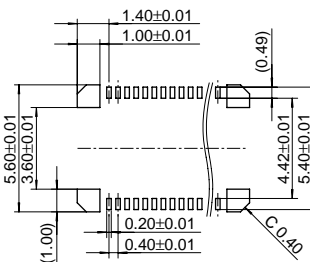

Recommended metal mask pattern

Metal mask thickness: Here, 120 μm
(Terminal portion opening area ratio: 66 %)
(Metal portion opening area ratio: 100 %)

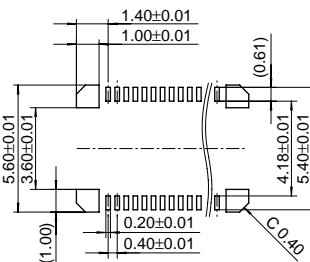

Header

Recommended PC board pattern
(Mount pad arrangement pattern)

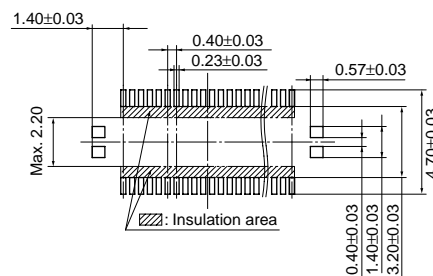

Relation between connector and mounting pad

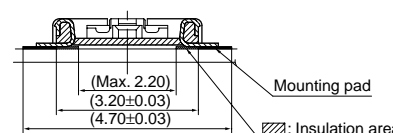

Recommended metal mask pattern

Metal mask thickness: Here, 150 μm
(Terminal portion opening area ratio: 52 %)
(Metal portion opening area ratio: 80 %)

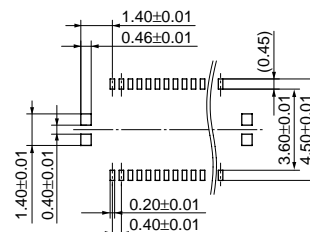

Recommended metal mask pattern

Metal mask thickness: Here, 120 μm
(Terminal portion opening area ratio: 66 %)
(Metal portion opening area ratio: 100 %)

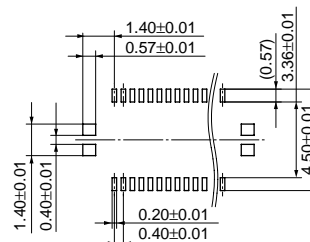

For other details, please verify with the product specification sheets.

NOTES FOR USING SMD TYPE CONNECTORS (Common)

Regarding the design of devices and PC board patterns

1) When connecting several connectors together by stacking, make sure to maintain proper accuracy in the design of structure and mounting equipment so that the connectors are not subjected to twisting and torsional forces.

2) With mounting equipment, there may be up to a ± 0.2 to 0.3-mm error in positioning. Be sure to design PC boards and patterns while taking into consideration the performance and abilities of the required equipment.

3) Some connectors have tabs embossed on the body to aid in positioning. When using these connectors, make sure that the PC board is designed with positioning holes to match these tabs.

4) To ensure the required mechanical strength when soldering the connector terminals, make sure the PC board meets recommended PC board pattern design dimensions given.

5) For all connectors of the narrow-pitch series, to prevent the PC board from coming off during vibrations or impacts, and to prevent loads from falling directly on the soldered portions, be sure to design some means to fix the PC board in place.

Example) Secure in place with screws

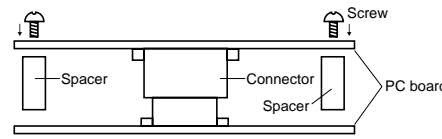

When connecting PC boards, take appropriate measures to prevent the connector from coming off.

6) Notes when using a FPC.

(1) When the connector is soldered to an FPC board, during its insertion and removal procedures, forces may be applied to the terminals and cause the soldering to come off. It is recommended to use a reinforcement board on the backside of the FPC board to which the connector is being connected. Please make the reinforcement board dimensions bigger than the outer limits of the recommended PC board pattern (should be approximately 1 mm greater than the outer limit).

Material should be glass epoxy or polyimide, and the thickness should be between 0.2 and 0.3 mm.

(2) Collisions, impacts, or turning of FPC boards, may apply forces on the

connector and cause it to come loose.

Therefore, make to design retaining plates or screws that will fix the connector in place.

7) The narrow-pitch connector series is designed to be compact and thin.

Although ease of handling has been taken into account, take care when mating the connectors, as displacement or angled mating could damage or deform the connector.

Regarding the selection of the connector placement machine and the mounting procedures

1) Select the placement machine taking into consideration the connector height, required positioning accuracy, and packaging conditions.

2) Be aware that if the catching force of the placement machine is too great, it may deform the shape of the connector body or connector terminals.

3) Be aware that during mounting, external forces may be applied to the connector contact surfaces and terminals and cause deformations.

4) Depending on the size of the connector being used, self alignment may not be possible. In such cases, be sure to carefully position the terminal with the PC board pattern.

5) The positioning bosses give an approximate alignment for positioning on the PC board. For accurate positioning of the connector when mounting it to the PC board, we recommend using an automatic positioning machine.

NOTES FOR USING SMD TYPE CONNECTORS (Common)

Regarding soldering

1. Reflow soldering

- 1) Measure the recommended profile temperature for reflow soldering by placing a sensor on the PC board near the connector surface or terminals. (The setting for the sensor will differ depending on the sensor used, so be sure to carefully read the instructions that comes with it.)
- 2) As for cream solder printing, screen printing is recommended.
- 3) See the specifications and drawings for the product in question for the metal mask pattern diagrams.
- 4) When mounting on both sides of the PC board and the connector is mounting on the underside, use adhesives or other means to ensure the connector is properly fixed to the PC board. (Double reflow soldering on the same side is possible.)
- 5) N₂ reflow, conducting reflow soldering in a nitrogen atmosphere, increases the solder flow too greatly, enabling wicking to occur. Make sure that the solder feed rate and temperature profile are appropriate.

Soldering conditions

Please use the reflow temperature profile conditions recommended below for reflow soldering. Please contact us before using a temperature profile other than that described below (e.g. lead-free solder).

- Narrow-pitch connectors (except P5 floating and P8 type)

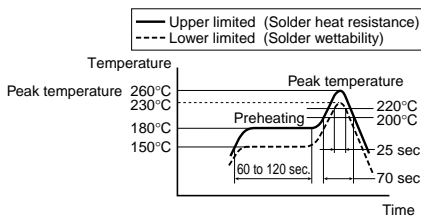

- Narrow-pitch connector (P5 floating, P8)

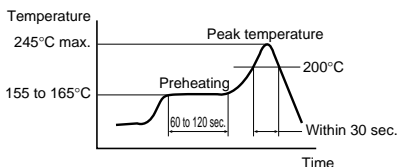

- For products other than the ones above, please refer to the latest product specifications.
- 6) The temperatures are measured at the surface of the PC board near the connector terminals. (The setting for the sensor will differ depending on the sensor used, so be sure to carefully read the instructions that comes with it.)
 - 7) The temperature profiles given in this catalog are values measured when using the connector on a resin-based PC board. When performed reflow soldering on a metal board (iron, aluminum, etc.) or a metal table to mount on a FPC, make sure there is no deformation or discoloration of the connector beforehand and then begin mounting.

2. Hand soldering

- 1) Set the soldering iron so that the tip temperature is less than that given in the table below.

Table A

Product name	Soldering iron temperature
SMD type connectors	300°C within 5 sec. 350°C within 3 sec.

- 2) Do not allow flux to spread onto the connector leads or PC board. This may lead to flux rising up to the connector inside.
- 3) Touch the soldering iron to the foot pattern. After the foot pattern and connector terminal are heated, apply the solder wire so it melts at the end of the connector terminals.

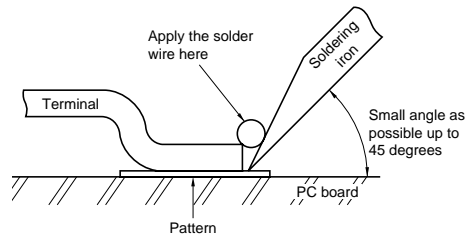

- 4) Be aware that soldering while applying a load on the connector terminals may cause improper operation of the connector.
- 5) Thoroughly clean the soldering iron.
- 6) Flux from the solder wire may get on the contact surfaces during soldering operations. After soldering, carefully check the contact surfaces and clean off any solder before use.
- 7) For soldering of prototype devices during product development, you can perform soldering at the necessary locations by heating with a hot-air gun by applying cream solder to the foot pattern beforehand. However, at this time, make sure that the air pressure does not move connectors by carefully holding them down with tweezers or other similar tool. Also, be careful not to go too close to the connectors and melt any of the molded components.
- 8) When soldering the shell terminals of, for example, I/O connectors, avoid applying an excessive amount of solder, or it may flow into the shell.

Example:

- Infdige Industrial, Ltd.
- Super Air Heater
- Digital temperature controller
- Air heater with internal temperature sensor

3. Solder reworking

- 1) Finish reworking in one operation.
- 2) For reworking of the solder bridge, use a soldering iron with a flat tip. To prevent flux from climbing up to the contact surfaces, do not add more flux.
- 3) Keep the soldering iron tip temperature below the temperature given in Table A.
- 4) When soldering the shell terminals of, for example, I/O connectors, avoid applying an excessive amount of solder, or it may flow into the shell.

NOTES FOR USING SMD TYPE CONNECTORS (Common)

Handling Single Components

- 1) Make sure not to drop or allow parts to fall from work bench
- 2) Excessive force applied to the terminals could cause them to warp, come out, or weaken the adhesive strength of the solder. Handle with care.
- 3) Repeated bending of the terminals may break them.
- 4) Do not use alcohol for cleaning. Doing so may whiten the surface of molded parts.

Cleaning flux from PC board

- 1) To increase the cleanliness of the cleaning fluid and cleaning operations, prepare equipment for a cleaning process that begins with boil cleaning, ultrasonic cleaning, and then to vapor cleaning.
- 2) Carefully oversee the cleanliness of the cleaning fluids to make sure that the contact surfaces do not become dirty from the cleaning fluid itself.
- 3) Since some powerful cleaning may dissolve molded components of the connector and wipe off printed letters, we recommend aqua pura electronic parts cleaners. Consult us if you wish other types of cleaning fluids.
- 4) Please note that the surfaces of molded parts may whiten when cleaned with alcohol.

Handling the PC board

• Handling the PC board after mounting the connector

When cutting or bending the PC board after mounting the connector, be careful that the soldered sections are subjected to excessive forces.

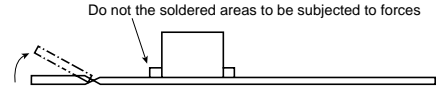

Storage of connectors

- 1) To prevent trouble from voids or air pockets by heat of reflow soldering, avoid storing the connectors in areas of high humidity. When storing the connectors for more than six months, be sure to store them in a storage area where the humidity is properly controlled.
- 2) Depending on the connector type, the color of the connector may vary from connector to connector if produced at

- different times, and some connectors more even change color slightly if subjected to ultraviolet rays during storage. This is normal and will not affect the operation of the connector.
- 3) When storing the connectors with the PC boards assembled and components already set, be careful not to stack them up so the connectors are subjected to excessive forces.

- 4) Avoid storing the connectors in locations with excessive dust. The dust may accumulate and cause improper connections at the contact surfaces.

Other Notes

- 1) These products are made for the design of compact and lightweight devices and therefore the thickness of the molded components has been made very thin. Therefore, be careful during insertion and removal operations for excessive forces applied may damage the products.
- 2) Dropping of the products or rugged mishandling may bend or damage the terminals and even hinder proper reflow soldering.

- 3) Before soldering, try not to insert or remove the connector more than absolutely necessary.
- 4) When coating the PC board after soldering the connector to prevent the deterioration of insulation, perform the coating in such a way so that the coating does not get on the connector.
- 5) There may be variations in the colors of products from different production lots. This is normal.
- 6) The connectors are not meant to be

- used for switching.
- 7) Be sure not to allow external pressure to act on connectors when assembling PCBs or moving in block assemblies.

Regarding sample orders to confirm proper mounting

When ordering samples to confirm proper mounting with the placement machine, connectors are delivered in 50-piece units in the condition given right. Consult a sale representative for ordering sample units.

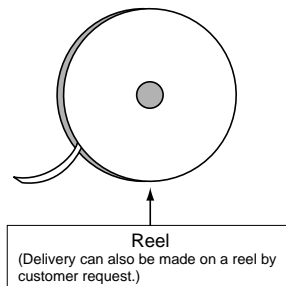
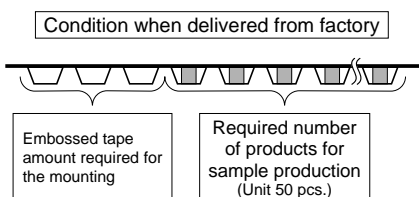

For other details, please verify with the product specification sheets.