

# MOS FET Relays

# G3VM-355C/CR/F/FR

**MOS FET Relay with Both SPST-NO and SPST-NC Contacts Incorporated in a Single DIP Package. General-purpose Models Added.**

- SPST-NO/SPST-NC models included in the 350-V load series.
- Continuous load current of 120 mA.
- Dielectric strength of 2,500 Vrms between I/O.
- General-purpose models (high ON resistance) added.
- RoHS Compliant.

### Application Examples

- Measurement devices
- Security systems
- Amusement machines

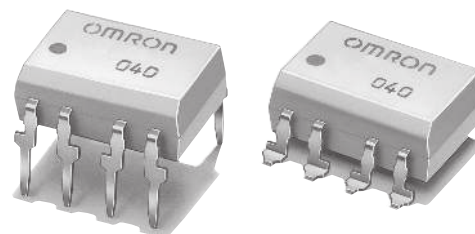

**Note:** The actual product is marked differently from the image shown here.

### List of Models

Contact form	Terminals	Load voltage (peak value)	Model	Number per stick	Number per tape	
SPST-NO/ SPST-NC	PCB terminals	350 VAC	G3VM-355CR	50	---	
			G3VM-355C			
			G3VM-355FR			
			G3VM-355F			
	Surface-mounting terminals		G3VM-355FR(TR)	---		1,500
			G3VM-355F(TR)			

### Dimensions

**Note:** All units are in millimeters unless otherwise indicated.

#### G3VM-355C/CR

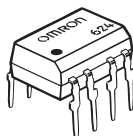

**Note:** The actual product is marked differently from the image shown here.

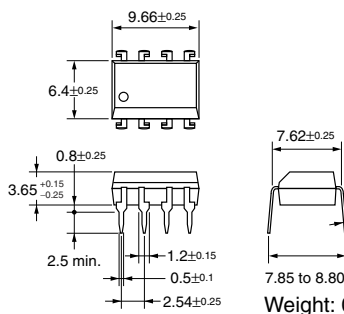

Weight: 0.54 g

#### G3VM-355F/FR

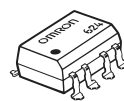

**Note:** The actual product is marked differently from the image shown here.

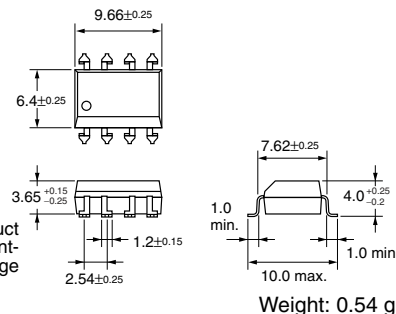

Weight: 0.54 g

### Terminal Arrangement/Internal Connections (Top View)

#### G3VM-355C/CR

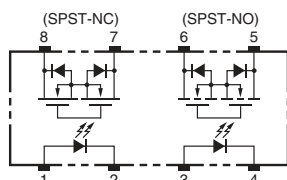

#### G3VM-355F/FR

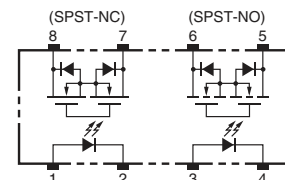

### PCB Dimensions (Bottom View)

#### G3VM-355C/CR

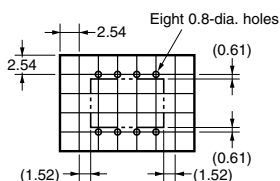

### Actual Mounting Pad Dimensions (Recommended Value, Top View)

#### G3VM-355F/FR

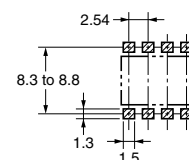

■ Absolute Maximum Ratings (Ta = 25°C)

Item	Symbol	Rating	Unit	Measurement conditions	
Input	LED forward current	$I_F$	50	mA	
	Repetitive peak LED forward current	$I_{FP}$	1	A	100 $\mu$ s pulses, 100 pps
	LED forward current reduction rate	$\Delta I_F/^\circ\text{C}$	-0.5	mA/°C	Ta $\geq$ 25°C
	LED reverse voltage	$V_R$	5	V	
	Connection temperature	$T_j$	125	°C	
Output	Load voltage (AC peak/DC)	$V_{OFF}$	350	V	
	Continuous load current (AC peak/DC)	$I_O$	120 (100)	mA	
	ON current reduction rate	$\Delta I_{ON}/^\circ\text{C}$	-1.2 (-1)	mA/°C	Ta $\geq$ 25°C
	Connection temperature	$T_j$	125	°C	
Dielectric strength between input and output (See note 1.)	$V_{I-O}$	2,500	$V_{rms}$	AC for 1 min	
Operating temperature	$T_a$	-40 to +85	°C	With no icing or condensation	
Storage temperature	$T_{stg}$	-55 to +125	°C	With no icing or condensation	
Soldering temperature (10 s)	---	260	°C	10 s	

Note: 1. The dielectric strength between the input and output was checked by applying voltage between all pins as a group on the LED side and all pins as a group on the light-receiving side.

Values in parentheses are for the G3VM-355C/F

■ Electrical Characteristics (Ta = 25°C)

Item	Sym	Minimum	Typical	Maximum	Unit	Measurement conditions	
Input	LED forward voltage	$V_F$	1.0	1.15	1.3	V	$I_F = 10$ mA
	Reverse current	$I_R$	---	---	10	$\mu$ A	$V_R = 5$ V
	Capacity between terminals	$C_T$	---	30	---	pF	$V = 0$ , $f = 1$ MHz
	Trigger LED forward current	$I_{FT}$	---	1	3	mA	SPST-NO: $I_O = 120$ mA (100 mA) SPST-NC: $I_{OFF} = 10$ $\mu$ A
Output	Maximum resistance with output ON	$R_{ON}$	---	15 (40)	25 (50)	$\Omega$	SPST-NO: $I_F = 5$ mA, $I_O = 120$ mA (100 mA) SPST-NC: $I_F = 0$ mA, $I_O = 120$ mA (100 mA)
				0.0015 NO (0.006)	1.0	$\mu$ A	$V_{OFF} = 350$ V
	Current leakage when the relay is open	$I_{LEAK}$	---	0.0105 NC (0.003)	---	---	---
Capacity between terminals	$C_{OFF}$	---	65 (30)	---	pF	$V = 0$ , $f = 1$ MHz (NO) $V = 0$ , $f = 1$ MHz, $I_F = 5$ mA (NC)	
Capacity between I/O terminals	$C_{I-O}$	---	0.8	---	pF	$f = 1$ MHz, $V_s = 0$ V	
Insulation resistance	$R_{I-O}$	1,000	---	---	M $\Omega$	$V_{I-O} = 500$ VDC, $R_{oh} \leq 60\%$	
Turn-ON time	SPST-NO	$t_{ON}$	---	0.18 (0.3)	1.0 (1.0)	ms	$I_F = 5$ mA, $R_L = 200$ $\Omega$ , $V_{DD} = 20$ V (See note 2.)
	SPST-NC	$t_{ON}$	---	0.15 (0.25)	1.0 (1.0)	ms	
Turn-OFF time	SPST-NO	$t_{OFF}$	---	0.11 (0.15)	1.0 (1.0)	ms	
	SPST-NC	$t_{OFF}$	---	0.7 (0.5)	3.0 (1.0)	ms	

Values in parentheses are for the G3VM-355C/F

■ Recommended Operating Conditions

Use the G3VM under the following conditions so that the Relay will operate properly.

Item	Symbol	Minimum	Typical	Maximum	Unit
Load voltage (AC peak/DC)	$V_{DD}$	---	---	280	V
Operating LED forward current	$I_F$	5	---	25	mA
Continuous load current (AC peak/DC)	$I_O$	---	---	120 (100)	mA
Operating temperature	$T_a$	-20	---	65	°C

Values in parentheses are for the G3VM-355C/F

Note: 2. Turn-ON and Turn-OFF Times

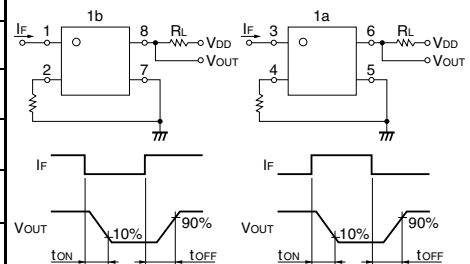

■ Engineering Data

G3VM-355C/F

Common Characteristics; SPST-NO / SPST-NC

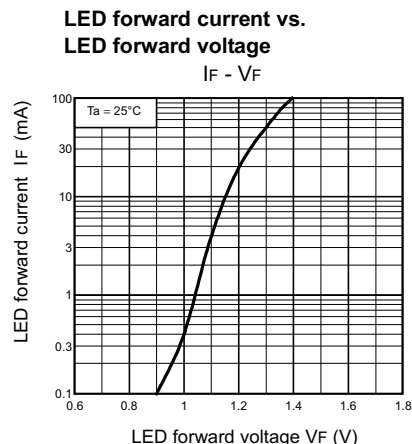
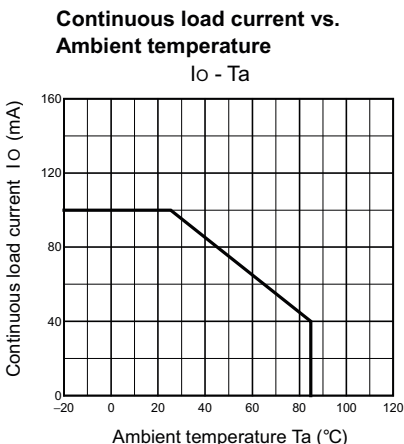
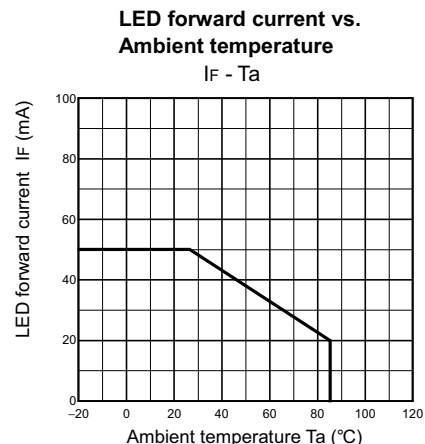

Characteristics; SPST-NO

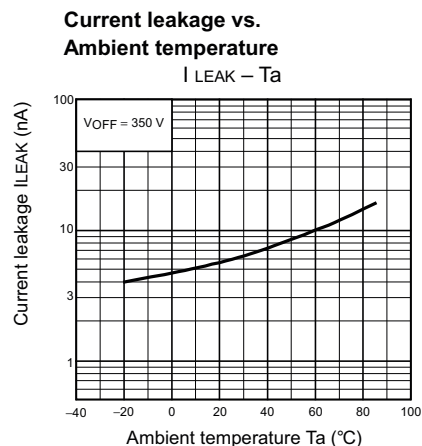
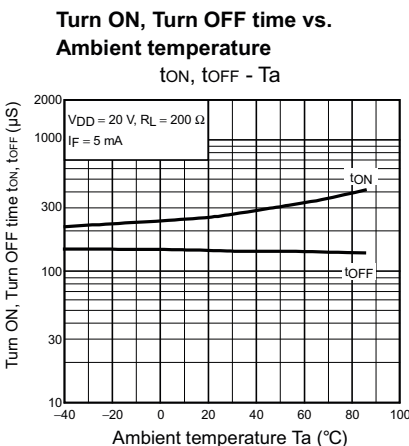
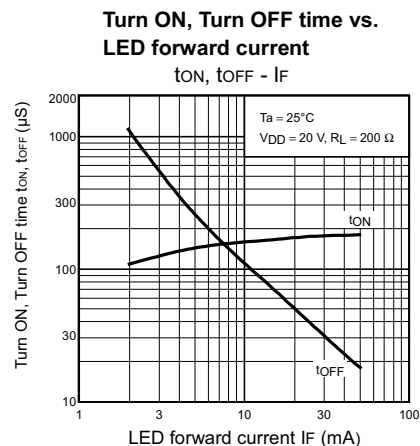
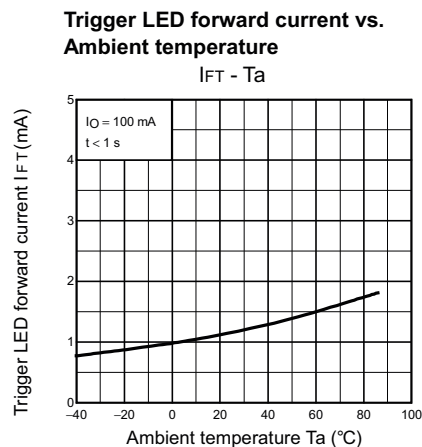
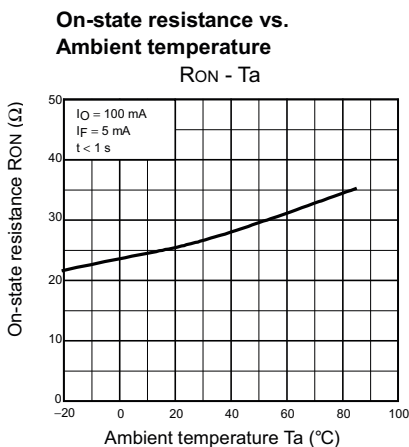
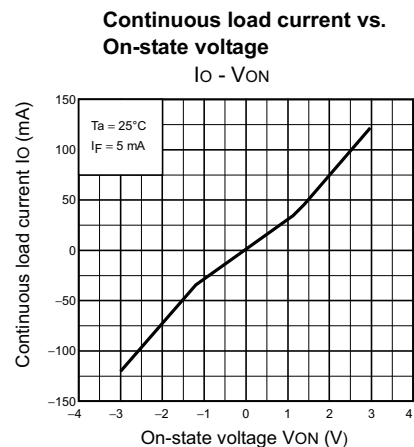

■ Engineering Data  
**G3VM-355C/F (continued)**  
 Characteristics; SPST-NC

**Continuous load current vs. On-state voltage**  
 $I_O - V_{ON}$

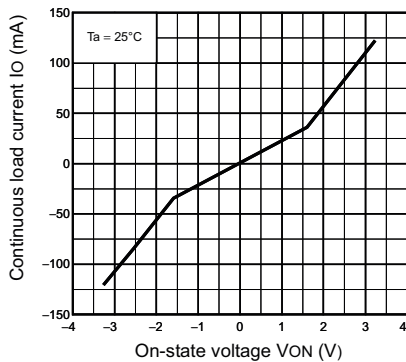

**On-state resistance vs. Ambient temperature**  
 $R_{ON} - T_a$

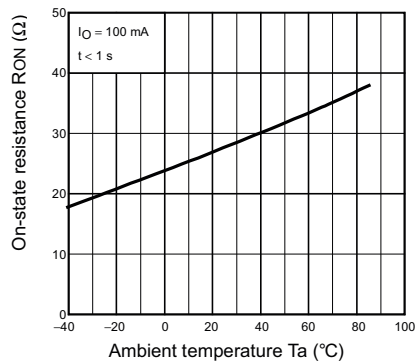

**Trigger LED forward current vs. Ambient temperature**  
 $I_{FC} - T_a$

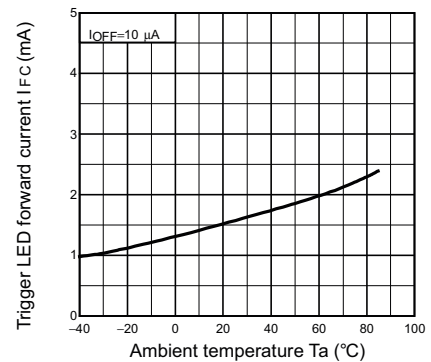

**Turn ON, Turn OFF time vs. LED forward current**  
 $t_{ON}, t_{OFF} - I_F$

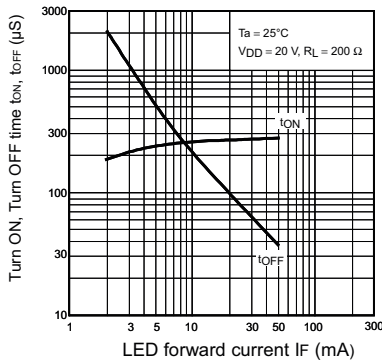

**Turn ON, Turn OFF time vs. Ambient temperature**  
 $t_{ON}, t_{OFF} - T_a$

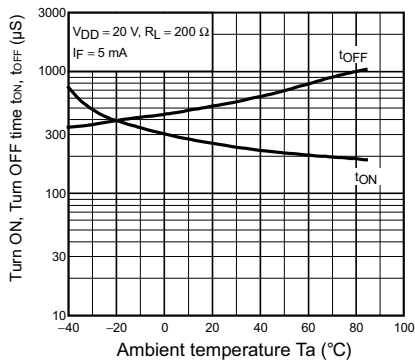

**Current leakage vs. Ambient temperature**  
 $I_{LEAK} - T_a$

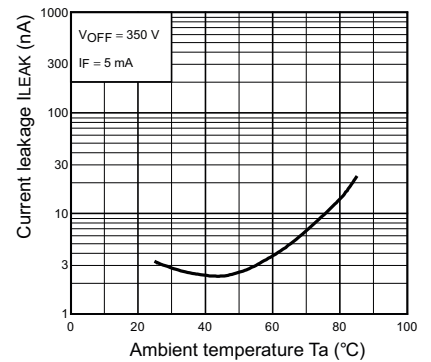

■ Engineering Data

G3VM-355CR/FR

Common Characteristics; SPST-NO / SPST-NC

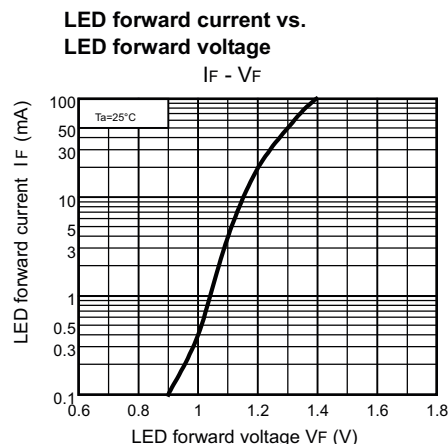
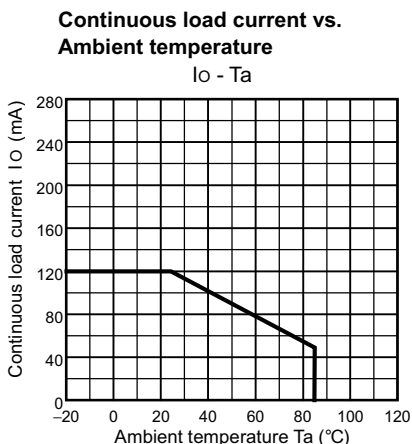
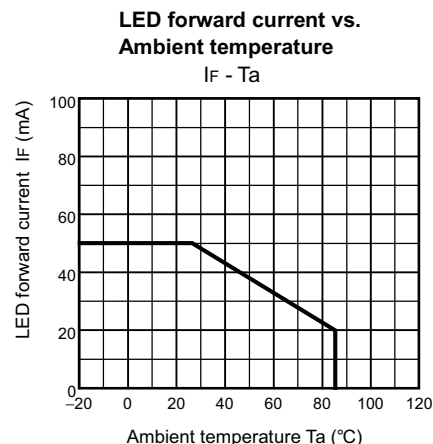

Characteristics; SPST-NO

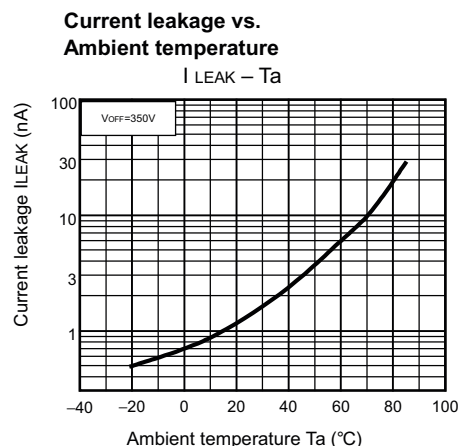
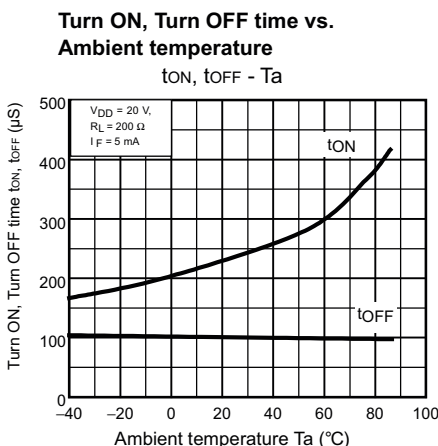
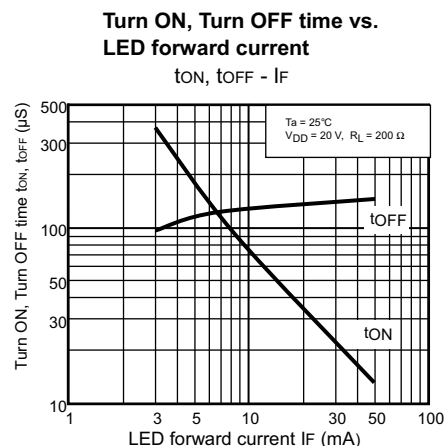
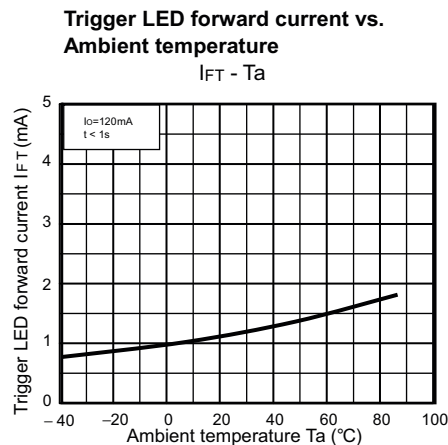
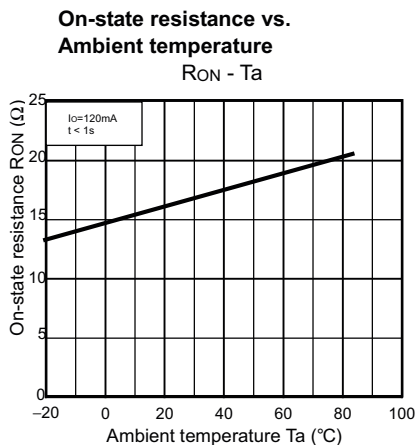
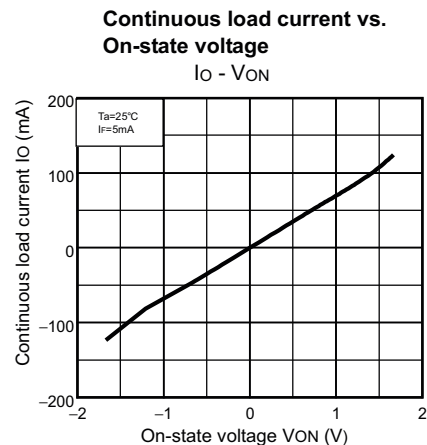

■ Engineering Data  
**G3VM-355CR/FR (continued)**  
 Characteristics; SPST-NC

**Continuous load current vs. On-state voltage**  
 $I_O - V_{ON}$

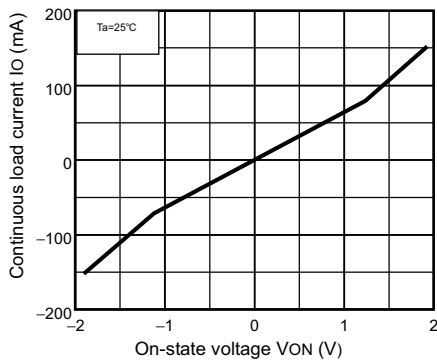

**On-state resistance vs. Ambient temperature**  
 $R_{ON} - T_a$

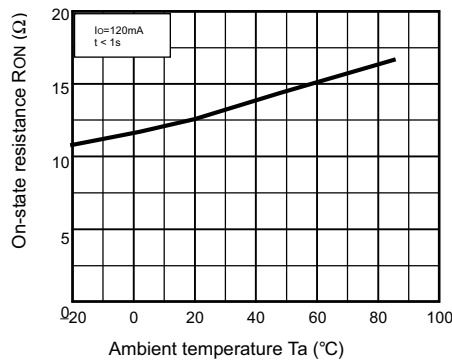

**Trigger LED forward current vs. Ambient temperature**  
 $I_{FC} - T_a$

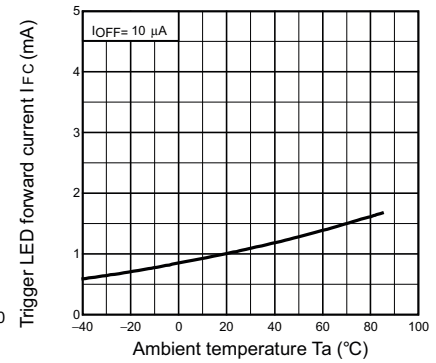

**Turn ON, Turn OFF time vs. LED forward current**  
 $t_{ON}, t_{OFF} - I_F$

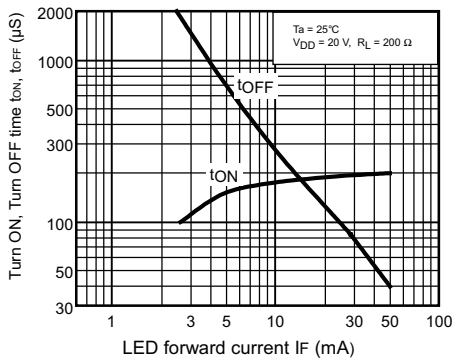

**Turn ON, Turn OFF time vs. Ambient temperature**  
 $t_{ON}, t_{OFF} - T_a$

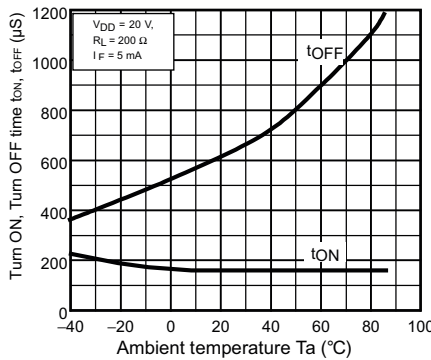

**Current leakage vs. Ambient temperature**  
 $I_{LEAK} - T_a$

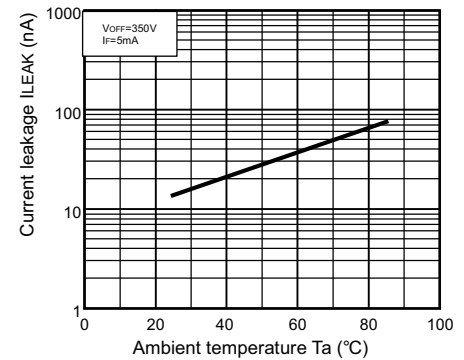

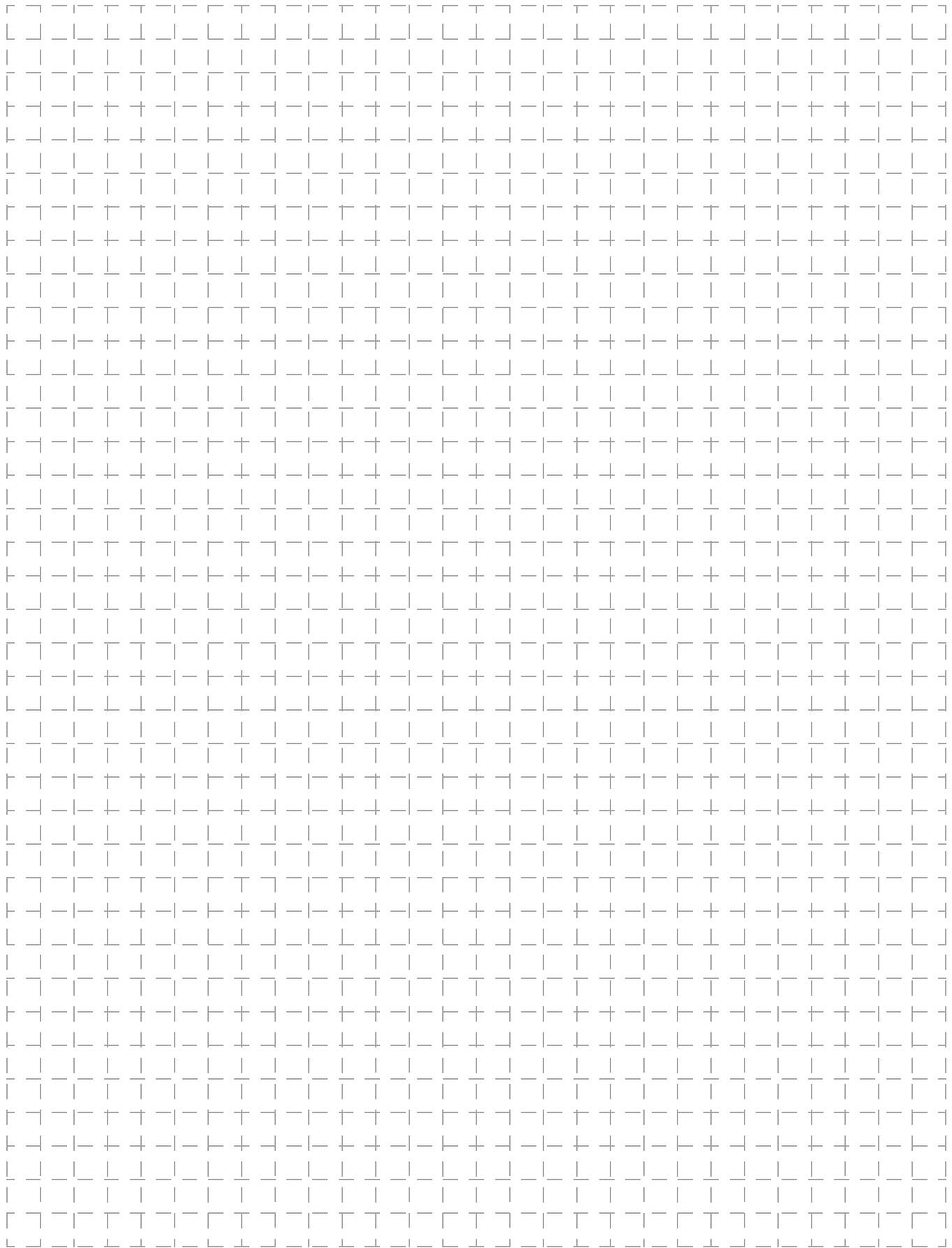

All sales are subject to Omron Electronic Components LLC standard terms and conditions of sale, which can be found at [http://www.components.omron.com/components/web/webfiles.nsf/sales\\_terms.html](http://www.components.omron.com/components/web/webfiles.nsf/sales_terms.html)

**ALL DIMENSIONS SHOWN ARE IN MILLIMETERS.**  
To convert millimeters into inches, multiply by 0.03937. To convert grams into ounces, multiply by 0.03527.

---

**OMRON**<sup>®</sup>

**OMRON ELECTRONIC  
COMPONENTS LLC**

55 E. Commerce Drive, Suite B  
Schaumburg, IL 60173

**847-882-2288**

**OMRON ON-LINE**

Global - <http://www.omron.com>

USA - <http://www.components.omron.com>

Cat. No. X302-E-1

12/10

Specifications subject to change without notice

Printed in USA