

PRODUCT NUMBER SEE SHEET 2

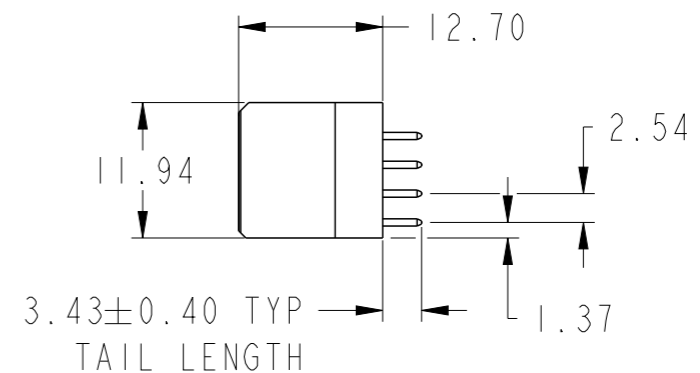

spec ref		dr	Rainbow Zhan	2014/07/04	projection 	MM ←→	size	A3	scale	3:2	
tolerance std ASME Y14.5		TOLERANCES UNLESS OTHERWISE SPECIFIED					eng	Rainbow Zhan	2014/07/15	ecn no	-
		chr	Li-He	2014/07/14			appr	Pei-Ming Zheng	2014/07/15	rel level	Released
surface	✓	linear	0.X	±0.50		5HP + 16S VT STB RECEPTACLE	dwg no	10106130-5004101	rev	A	
			0.XX	±0.25							
		angular	0°	±2°							www.fci.com

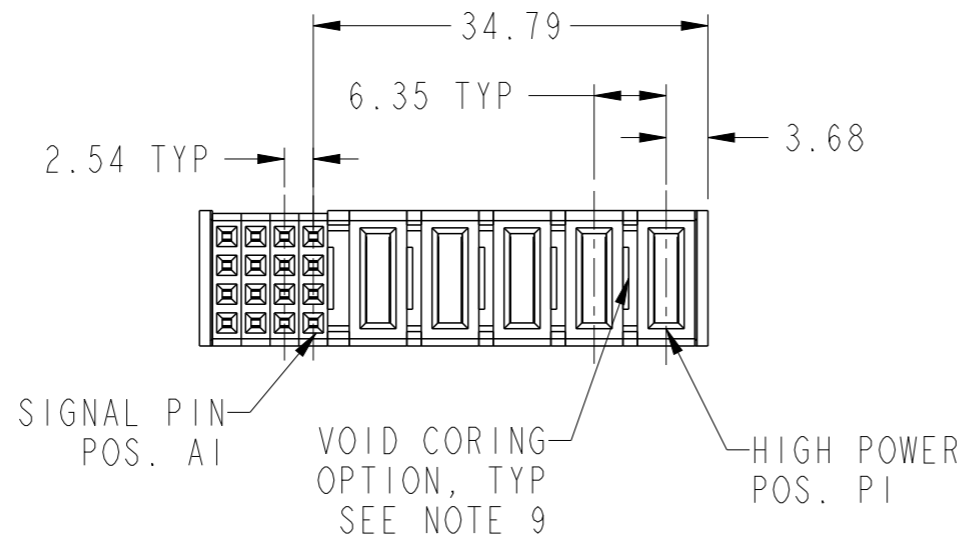
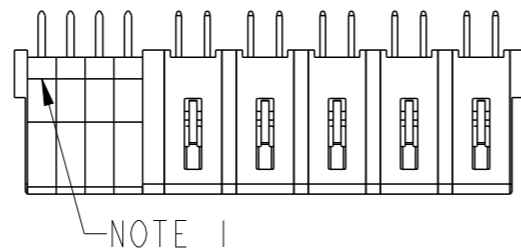
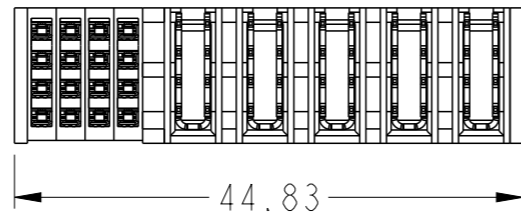

Copyright FCI.

PRODUCT NO.	ROWS	SIGNAL				HIGH POWER					E2
		E1	4	3	2	1	P5	P4	P3	P2	
10106130-5004101LF	D C B A	E	E	E	E	H3	H3	H3	H3	H3	

CODE	DESCRIPTION
E	STD SIGNAL CONTACT
H3	STD HIGH POWER CONTACT (3.43)

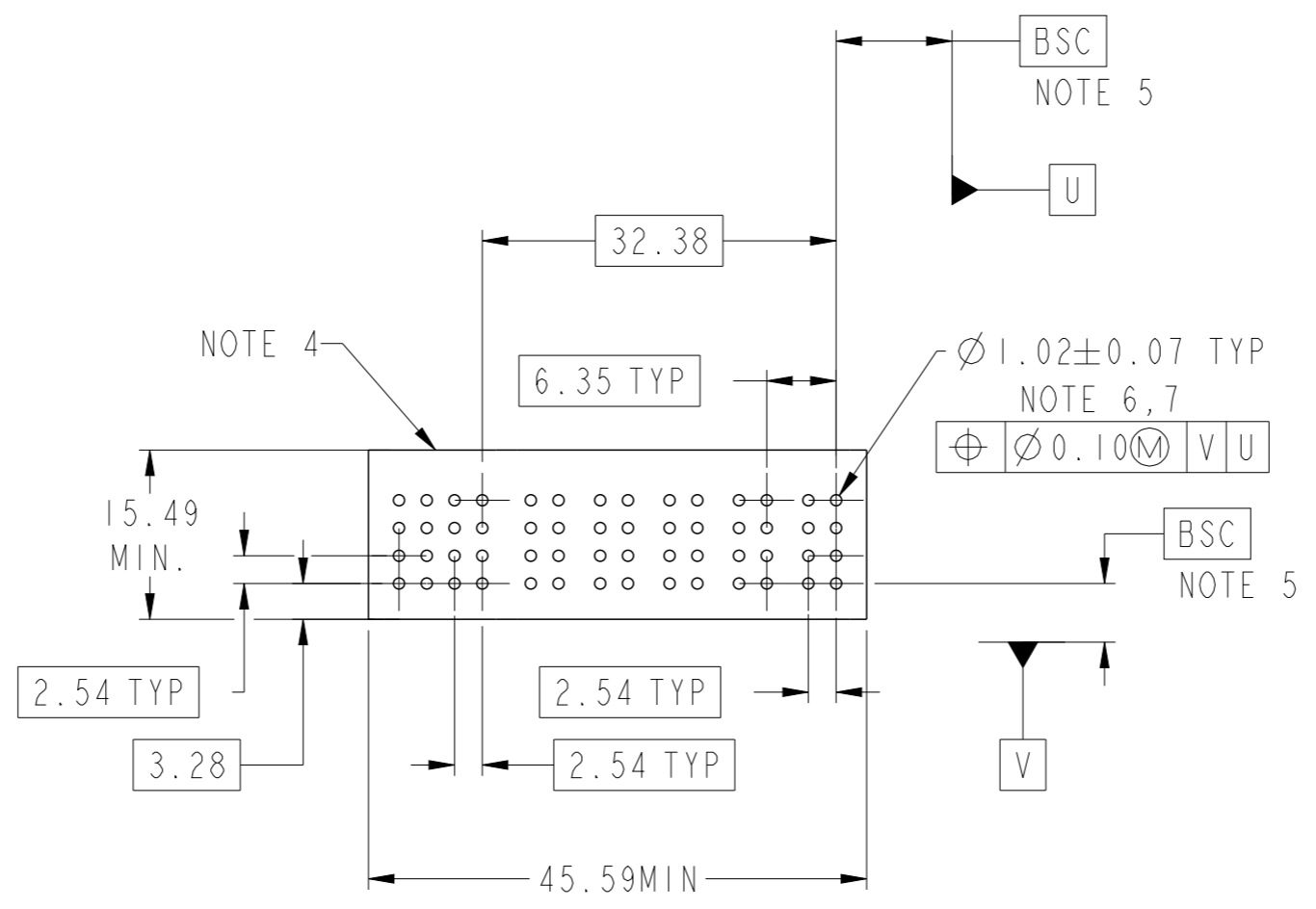

Copyright FCI.



dr	Rainbow Zhan	2014/07/04	projection	MM	size	A3	scale	3:2
eng	Rainbow Zhan	2014/07/15			ecn no			
chr	Li-He	2014/07/14			-			
appr	Pei-Ming Zheng	2014/07/15	product family	PowerBlade+	rel level		Released	
		5HP + 16S			dwg no	10106130-5004101		rev
www.fci.com		cat. no.			Product - Customer Drw		sheet 2 of 3	
		VT STB RECEPTACLE					A	

NOTES:

- 1) "FCI", PART NUMBER AND DATE CODE TO BE MARKED ON THIS SURFACE.  
THE MARK CAN BE OMITTED IF THERE IS NOT ENOUGH SPACE ON THIS SURFACE.
- 2) MATERIALS:  
-HOUSING - GLASS FILLED WITH HIGH TEMP THERMOPLASTIC, UL94V-0.  
-SIGNAL CONTACT - COPPER ALLOY.  
-POWER CONTACT - HIGH CONDUCTIVITY COPPER ALLOY.
- 3) PLATING SPECIFICATION REFER TO FCI 10124315.
- 4) DENOTES CONNECTOR KEEP OUT ZONE.
- 5) DATUM AND BASIC DIMENSIONS WERE ESTABLISHED BY CUSTOMER.
- 6) ALL HOLE DIAMETERS ARE FINISHED HOLE SIZES.
- 7)  $1.15 \pm 0.025$ MM DRILLED HOLE PLATED WITH 0.00762MM MIN Sn  
OVER 0.0254-0.0762MM Cu PLATING TO ACHIEVE A  $1.02 \pm 0.07$ MM HOLE.
- 8) PRODUCT SPECIFICATION REFER TO FCI GS-12-658.  
APPLICATION SPECIFICATION REFER TO FCI GS-20-141.  
PRODUCT PACKAGED IN TRAYS, REFER TO FCI GS-14-1502.
- 9) THE VOID CORING IN BETWEEN POWER MODULES, SIGNAL  
MODULES AND END MODULES ARE OPTIONAL AND THE SHAPE  
MAY BE DIFFERENT FOR OPTIMIZE THE MOLDING PROCESS. THE  
VOID CORING WILL NOT EFFECT TO PRODUCT FUNCTION.

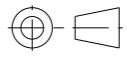
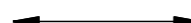

Copyright FCI.

dr	Rainbow Zhan	2014/07/04	projection 	MM 	size	A3	scale	1:1
eng	Rainbow Zhan	2014/07/15			ecn no	-		
chr	Li-He	2014/07/14			rel level	Released		
appr	Pei-Ming Zheng	2014/07/15			product family	PowerBlade+		
		title 5HP + 16S VT STB RECEPTACLE		dwg no 10106130-5004101	rev A			
<a href="http://www.fci.com">www.fci.com</a>		cat. no.	Product - Customer Drw		sheet 3 of 3			