

MAX5087

45V, 400mA, Low-Quiescent-Current Linear Regulator with Adjustable Reset Delay

General Description

The MAX5087 high-voltage linear regulator operates from an input voltage of 6.5V to 45V and delivers up to 400mA of output current. The device consumes only 70 μ A of quiescent current with no load and 11 μ A in shutdown. The device includes a SET input, that when connected to ground, selects a preset output voltage of 3.3V (MAX5087A) or 5.0V (MAX5087B). Alternatively, the output voltage can be adjusted from 2.5V to 11V by simply connecting SET to the regulator's output through a resistive divider network. The MAX5087 also provides an open-drain, active-low microprocessor (μ P) reset output that asserts when the regulator output drops below the preset output voltage threshold. An external capacitor programs the reset timeout period. Other features include an enable input, thermal shutdown, and short-circuit protection.

The MAX5087 operates over the automotive temperature range of -40°C to +125°C and is available in a 16-pin TQFN thermally enhanced package.

Applications

- Industrial
- Home Security/Safety
- Networking

Features

- Wide Operating Input Voltage Range (6.5V to 45V)
- Thermally Enhanced Package Dissipates 2.6W at $T_A = +70^\circ\text{C}$ (16-Pin TQFN)
- Guaranteed 400mA Output Current
- 70 μ A Quiescent Supply Current
- Preset 3.3V, 5.0V, or Adjustable 2.5V to 11V Output Voltage
- Remote Load Sense Capability
- Enable Input
- Integrated μ P Reset Circuit with Programmable Timeout Period
- Thermal and Short-Circuit Protection
- -40°C to +125°C Operating Temperature Range

Ordering Information

PART	PIN-PACKAGE	OUTPUT VOLTAGE (V)
MAX5087AATE+	16 TQFN-EP*	3.3
MAX5087BATE+	16 TQFN-EP*	5.0
MAX5087BATE/V+	16 TQFN-EP*	5.0

Note: All devices are specified over the -40°C to +125°C operating temperature range.

*EP = Exposed paddle.

+Denotes lead-free package.

Pin Configuration

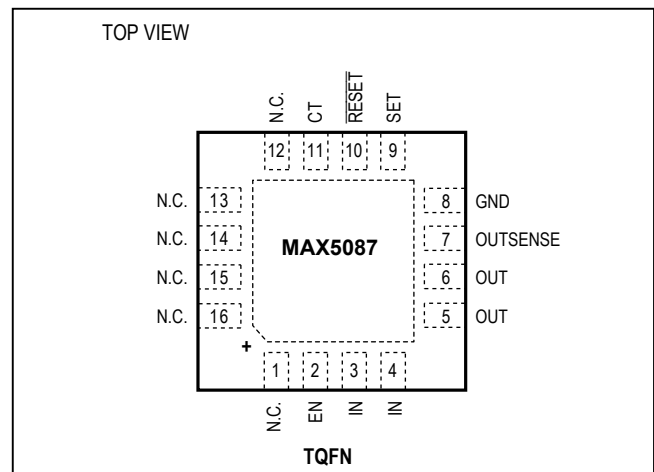

Absolute Maximum Ratings

IN to GND (do not exceed package power dissipation).....	-0.3V to +50V	Maximum Current into Any Pin (Except IN, OUT).....	±20mA
IN to GND (T ≤ 300ms, I _{OUT} ≤ 250mA).....	-0.3V to +42V	Continuous Power Dissipation (T _A = +70°C)	
EN to GND.....	-0.3V to +50V	16-Pin TQFN (derate 33.3mW/°C above +70°C).....	2666mW
RESET, OUT, OUTSENSE to GND.....	-0.3V to +12V	Operating Temperature Range.....	-40°C to +125°C
IN to OUT.....	-0.3V to +50V	Junction Temperature.....	+150°C
CT, SET TO GND.....	-0.3V to +35V	Storage Temperature Range.....	-60°C to +150°C
Short-Circuit Duration (V _{IN} ≤ 14V).....	Continuous	Lead Temperature (soldering, 10s).....	+300°C

Stresses beyond those listed under "Absolute Maximum Ratings" may cause permanent damage to the device. These are stress ratings only, and functional operation of the device at these or any other conditions beyond those indicated in the operational sections of the specifications is not implied. Exposure to absolute maximum rating conditions for extended periods may affect device reliability.

Package Thermal Characteristics (Note 1)

TQFN	Junction-to-Ambient Thermal Resistance (θ _{JA}).....	30.0°C/W	Junction-to-Case Thermal Resistance (θ _{JC}).....	2°C/W
------	--	----------	---	-------

Note 1: Package thermal resistances were obtained using the method described in JEDEC specification JESD51-7, using a four-layer board. For detailed information on package thermal considerations, refer to www.maximintegrated.com/thermal-tutorial.

Electrical Characteristics

(V_{IN} = 14V, I_{OUT} = 1mA, C_{IN} = 47µF (low ESR), C_{OUT} = 15µF, V_{EN} = 2.4V, 10kΩ from RESET to OUT, T_A = T_J = -40°C to +125°C, unless otherwise noted. Typical specifications are at T_A = +25°C.) (Note 2)

PARAMETER	SYMBOL	CONDITIONS	MIN	TYP	MAX	UNITS	
Input Voltage Range	V _{IN}	V _{IN} ≥ V _{OUT} + 1.5V	6.5		45.0	V	
Supply Current	I _Q	Measured at GND, SET = GND	I _{OUT} = 0	70	150	µA	
			I _{OUT} = 400mA	5300			
Shutdown Supply Current	I _{SHDN}	V _{EN} P 0.4V		11	21	µA	
REGULATOR							
Guaranteed Output Current	I _{OUT}	V _{IN} = 6.5V, V _{OUT} = 5.0V	400			mA	
Output Voltage (Note 3)	V _{OUT}	SET = GND, 5V version	6.5V P V _{IN} ≤ 25V, 5mA P I _{OUT} ≤ 400mA	4.87	5	5.13	V
			6.5V P V _{IN} ≤ 45V, 5mA P I _{OUT} ≤ 100mA	4.850	5	5.150	
		SET = GND, 3.3V version	6.5V P V _{IN} ≤ 25V, 5mA P I _{OUT} ≤ 400mA	3.208	3.3	3.392	
			6.5V P V _{IN} ≤ 45V, 5mA P I _{OUT} ≤ 100mA	3.208	3.3	3.392	
		I _{OUT} = 5mA, adjustable range	2.5		11.0		
Dropout Voltage	ΔV _{DO}	I _{OUT} = 400mA, V _{OUT} = 5V (Note 4)		0.9	2.2	V	
Startup Response Time		Rising edge of V _{IN} to V _{OUT} , R _L = 500Ω, SET = GND (Note 5)		400		µs	
Line Regulation	ΔV _{OUT} / ΔV _{IN}	8V ≤ V _{IN} ≤ 45V	5V version	-1	+1	mV/V	
			3.3V version	-0.5	+0.5		
Enable Voltage	V _{EN}	V _{EN} = high, regulator on	2.4			V	
		V _{EN} = low, regulator off			0.4		

Electrical Characteristics (continued)

($V_{IN} = 14V$, $I_{OUT} = 1mA$, $C_{IN} = 47\mu F$ (low ESR), $C_{OUT} = 15\mu F$, $V_{EN} = 2.4V$, $10k\Omega$ from \overline{RESET} to OUT, $T_A = T_J = -40^\circ C$ to $+125^\circ C$, unless otherwise noted. Typical specifications are at $T_A = +25^\circ C$.) (Note 2)

PARAMETER	SYMBOL	CONDITIONS	MIN	TYP	MAX	UNITS
Enable Input Current	I_{EN}	$V_{EN} = 2.4V$		0.35		μA
		$V_{EN} = 14V$		3.4		
SET Reference Voltage	V_{SET}		1.200	1.235	1.260	V
SET Input Leakage Current	I_{SET}		-100	+0.5	+100	nA
Load Regulation	$\frac{\Delta V_{OUT}}{\Delta I_{OUT}}$	$I_{OUT} = 1mA$ to 400mA (Note 3)		0.1	0.35	Ω
Power-Supply Rejection Ratio	PSRR	$I_{OUT} = 10mA$, $f = 100Hz$, 500mV _{p-p} , $V_{OUT} = 5V$		70		dB
Short-Circuit Current	I_{SC}	$V_{IN} < 14V$ (Note 6)		640		mA
Thermal Shutdown Temperature	$T_{J(SHDN)}$			175		$^\circ C$
Thermal Shutdown Hysteresis	$\Delta T_{J(SHDN)}$			25		$^\circ C$
\overline{RESET} Voltage Threshold	$V_{\overline{RESET}}$		89	92	94	% V_{OUT}
\overline{RESET} Threshold Hysteresis	V_{RHYST}			2		% V_{OUT}
\overline{RESET} Output Low Voltage	V_{RL}	$I_{SINK} = 1mA$			0.4	V
\overline{RESET} Output Leakage Current	I_{RH}	$V_{\overline{RESET}} = 5V$			1	μA
\overline{RESET} Output Minimum Timeout Period		When V_{OUT} reaches \overline{RESET} threshold, $C_{CT} = Open$		15		μs
ENABLE to \overline{RESET} Minimum Timeout Period		When EN goes high, $C_{CT} = open$		170		μs
Delay Comparator Threshold (Rising)			1.196	1.230	1.264	V
Delay Comparator Threshold Hysteresis				100		mV
CT Charge Current			1	2	4	μA
CT Discharge Current				5		mA

Note 2: Limits at $T_A = -40^\circ C$ are guaranteed by design.

Note 3: Output voltage is tested using a pulsed load current of less than 50ms duration.

Note 4: Dropout voltage is defined as $(V_{IN} - V_{OUT})$ when V_{OUT} is 100mV below the value of V_{OUT} for $V_{IN} = V_{OUT} + 3V$.

Note 5: Startup time measured from 50% of V_{IN} to 90% of V_{OUT} .

Note 6: Continuous short-circuit protection for $V_{IN} > 14V$ not guaranteed.

Typical Operating Characteristics

($V_{IN} = V_{EN} = 14V$, $C_{IN} = 47\mu F$ (low ESR), $C_{OUT} = 15\mu F$, $V_{OUT} = 5V$, SET = GND, $T_A = +25^\circ C$, unless otherwise specified.)

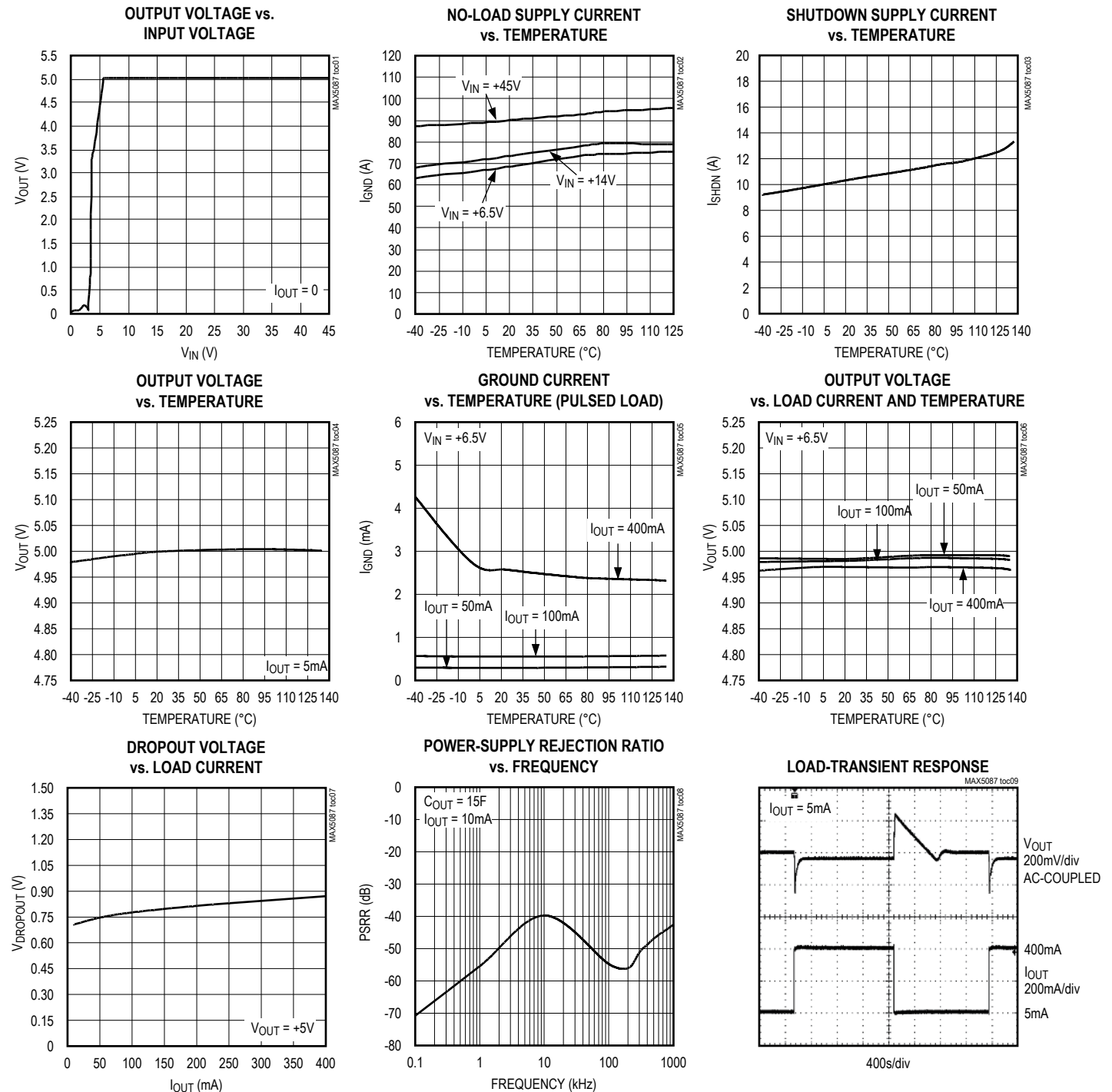

Typical Operating Characteristics (continued)

($V_{IN} = V_{EN} = 14V$, $C_{IN} = 47\mu F$ (low ESR), $C_{OUT} = 15\mu F$, $V_{OUT} = 5V$, $SET = GND$, $T_A = +25^\circ C$, unless otherwise specified.)

INPUT VOLTAGE STEP RESPONSE

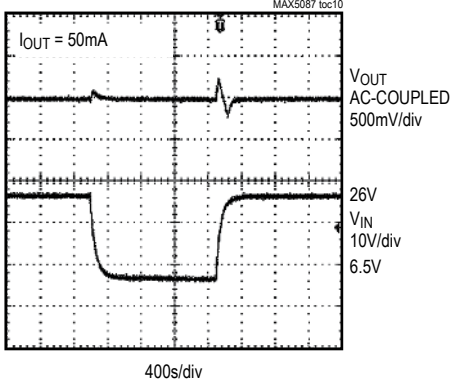

STARTUP RESPONSE

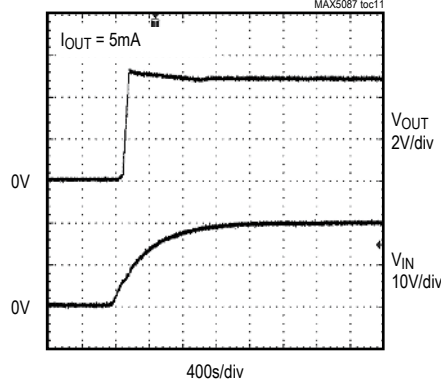

ENABLE STARTUP RESPONSE

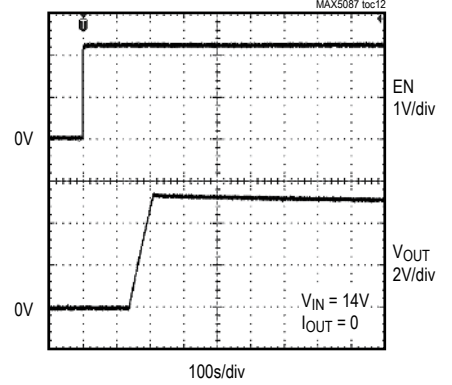

ENABLE STARTUP RESPONSE

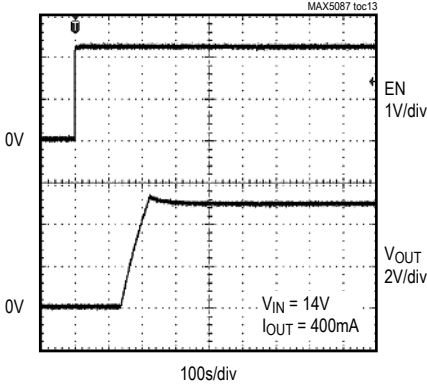

ENABLE STARTUP RESPONSE

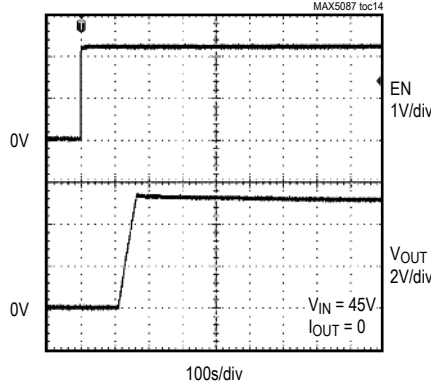

ENABLE STARTUP RESPONSE

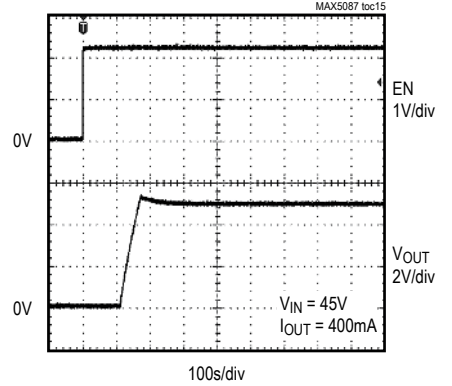

SHUTDOWN RESPONSE

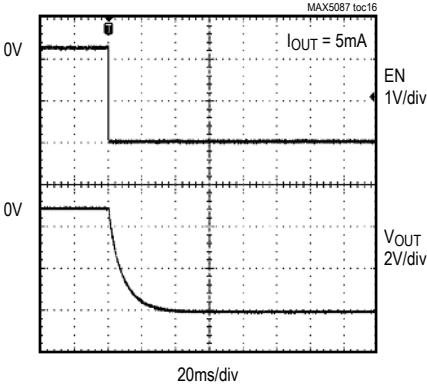

GROUND CURRENT DISTRIBUTION
($T_A = -40^\circ C$)

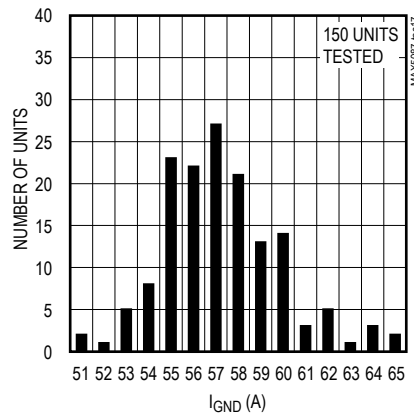

GROUND CURRENT DISTRIBUTION
($T_A = +125^\circ C$)

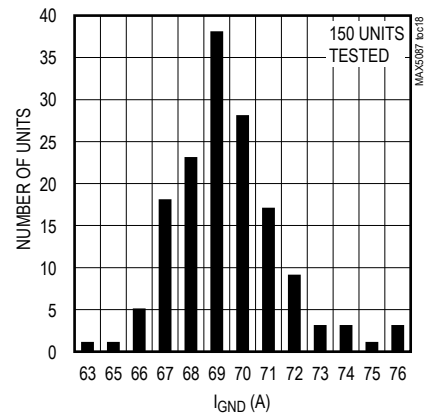

Pin Description

PIN	NAME	FUNCTION
1, 12–16	N.C.	No Connection. Not internally connected.
2	EN	Enable Input. Drive EN high to turn on the regulator. Force EN low to place the device in shutdown mode.
3, 4	IN	Regulator Input. Supply voltage ranges from 6.5V to 45V. Bypass IN to GND with a low-ESR 47 μ F electrolytic capacitor.
5, 6	OUT	Regulator Output. Connect at least a 15 μ F low-ESR capacitor from OUT to GND.
7	OUTSENSE	Regulator Output Feedback Point. OUTSENSE must be connected to OUT for fixed output voltage versions. Leave OUTSENSE open for adjustable output voltage version.
8	GND	Ground
9	SET	Feedback Regulation Set Point. Connect SET to GND for a fixed 3.3V output (MAX5087A) or 5.0V output (MAX5087B). Connect an external resistive divider network from OUTSENSE to SET to GND to adjust the output voltage from 2.5V to 11V.
10	$\overline{\text{RESET}}$	Open-Drain Active-Low Reset Output. Connect a 10k Ω pullup resistor from $\overline{\text{RESET}}$ to any supply voltage up to 11V to create a logic output.
11	CT	Reset Timeout Setting Connection. A 2 μ A charging current is available at CT. Connect a capacitor from CT to GND to set the reset timeout period (see the <i>Adjustable Reset Timeout Period (CT)</i> section).
—	EP	Exposed Paddle. Connect externally to a large ground plane to aid heat dissipation. Do not use EP as a ground connection.

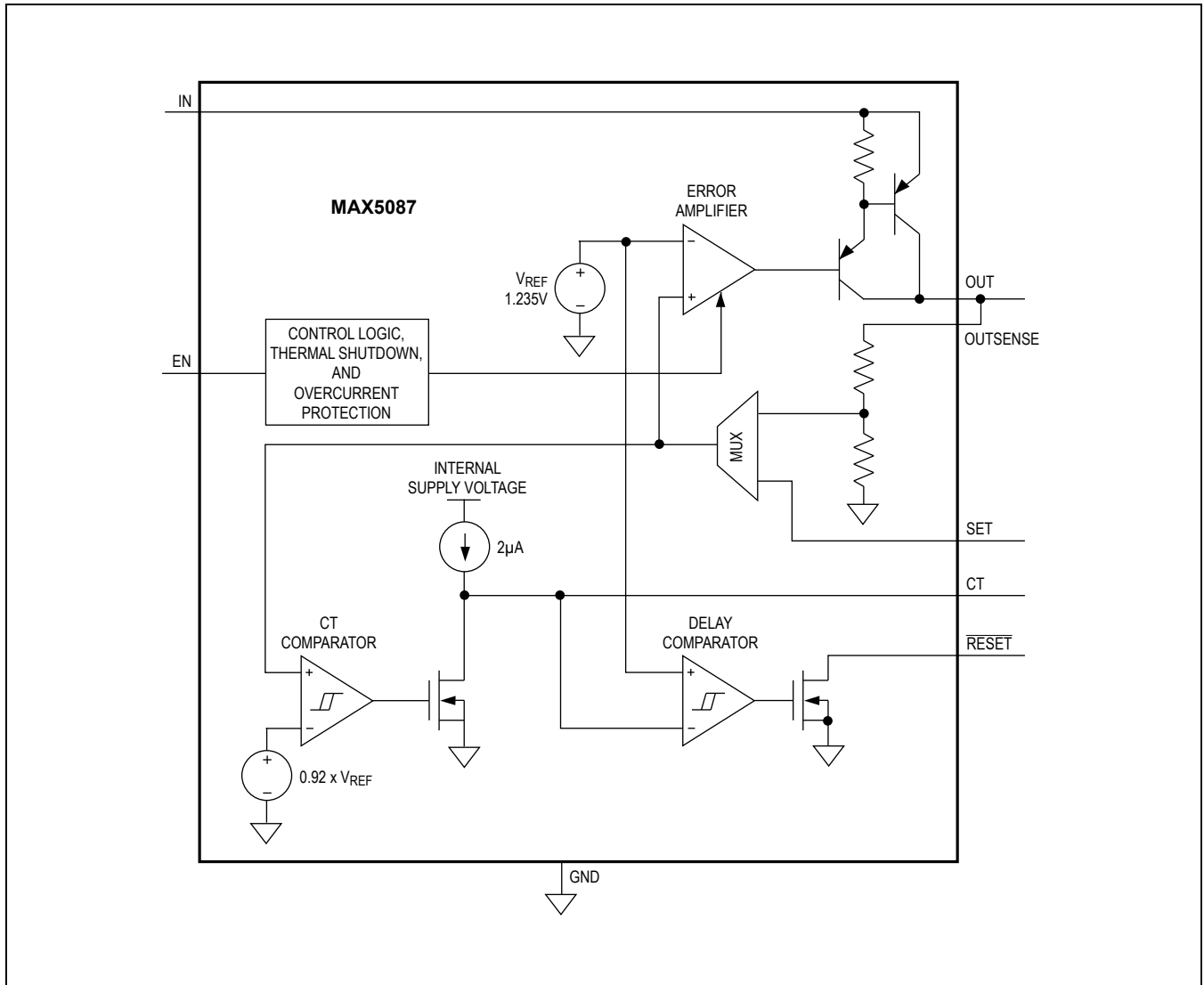

Figure 1. Functional Diagram

Detailed Description

The MAX5087 high-voltage linear regulator includes an integrated μP reset circuit with an adjustable reset timeout period (see the [Adjustable Reset Timeout Period \(CT\)](#) section). The device guarantees a 400mA load current and is available with a preset output voltage of 3.3V (MAX5087A) or 5V (MAX5087B). Both devices can be configured to provide an adjustable output voltage from 2.5V to 11V. The internal reset circuit monitors the regulator output voltage and asserts $\overline{\text{RESET}}$ low when the regulator output falls below the reset threshold voltage. Other features include an enable (regulator control input), 21 μA (max) shutdown current, short-circuit protection (see the [Output Short-Circuit Current Limit](#) section), and thermal shutdown (see the [Thermal Protection](#) section).

Regulator

The MAX5087 accepts an input voltage range from 6.5V to 45V and offers a fixed output voltage of 3.3V or 5V. For an adjustable output voltage operation, use an external resistive divider network connected between OUT, SET, and GND (see [Figure 2](#)).

Enable Input (EN)

EN is a logic-level enable input that turns the device on/off. Drive EN high to turn on the device and drive EN low to place the device in shutdown. The MAX5087 draws 11 μA (typ) of supply current when in shutdown. EN withstands voltages up to +45V, allowing EN to be connected to IN for an always-on operation.

Remote Sensing (OUTSENSE)

The 3.3V (MAX5087A) and 5V (MAX5087B) output voltage versions connect OUTSENSE for load voltage sensing. Leave OUTSENSE open when using adjustable output voltage version.

Reset Output ($\overline{\text{RESET}}$)

A supervisor circuit is fully integrated in the MAX5087 and uses the same reference voltage as the regulator. $\overline{\text{RESET}}$ goes low if V_{OUT} drops below the preset output voltage threshold, and remains low at least for the timeout period after V_{OUT} rises above the reset voltage threshold.

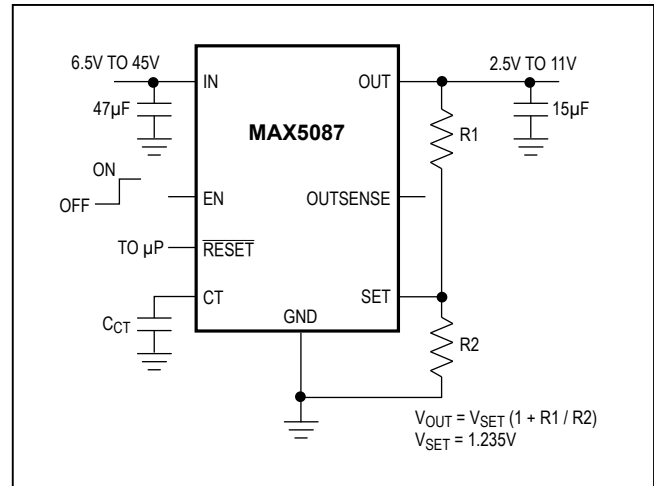

Figure 2. Setting the Adjustable Output Voltage

Adjustable Reset Timeout Period (CT)

The MAX5087 features a user-adjustable reset timeout. Connect a capacitor from CT to GND to set the reset timeout period (see [Figure 2](#)) and use the following equation to calculate the timeout period:

$$t_{\text{RP}} = C_{\text{CT}} \times 0.6175 \times 10^6 \text{ (s)}$$

where C_{CT} is the value of the external capacitor connected from CT to GND.

Thermal Protection

When the junction temperature exceeds $T_{\text{J}} = +175^{\circ}\text{C}$, an internal thermal sensor signals the shutdown logic, which turns off the pass transistor, allowing the IC to cool. The thermal sensor turns the pass transistor on again after the IC's junction temperature cools by 25°C , resulting in a cycled output during continuous thermaloverload conditions. Thermal protection protects the MAX5087 in the event of fault conditions. During continuous operation, do not exceed the absolute maximum junction temperature rating of $T_{\text{J}} = +150^{\circ}\text{C}$.

Output Short-Circuit Current Limit

The MAX5087 features a current limit. The output can be shorted to GND for an indefinite period of time (for $V_{\text{IN}} < 14\text{V}$) without damage to the device. Continuous output short-circuit protection is only guaranteed for $V_{\text{IN}} < 14\text{V}$.

Applications Information

Output-Voltage Selection

The MAX5087 features a Dual Mode™ operation, in either a preset-voltage mode or an adjustable mode. In preset-voltage mode, internal feedback resistors set the MAX5087's output voltage to +3.3V or +5V. Select preset-voltage mode by connecting SET to ground. In adjustable mode, select an output between +2.5V and +11V using two external resistors connected as a voltage-divider to SET (Figure 2). Set the output voltage using the following equation:

$$V_{OUT} = V_{SET} \times \left(1 + \frac{R1}{R2}\right)$$

where $V_{SET} = 1.235V$ and $R2$ is chosen to be $< 100k\Omega$.

Available Output-Current Calculation

The MAX5087 high-voltage regulator provides up to 400mA of output current. The input voltage extends to +45V. Package power dissipation limits the amount of output current available for a given input/output voltage and ambient temperature. Figure 3 shows the maximum power dissipation curve for these devices. The graph assumes that the exposed paddle of the MAX5087 package is set up per JEDEC 51 (multilayer board) specifications.

Use Figure 3 to determine the allowable package dissipation (P_D) for a given ambient temperature. Alternately, use the following formulas to calculate the allowable package dissipation. Note that for the examples shown below, the electrical characteristic limits are guaranteed up to $T_J = +125^\circ C$ (max).

$$P_D = \begin{cases} 2.666W & \text{for } T_A \leq +70^\circ C \\ 2.666W - 0.0333 \frac{W}{^\circ C} \times (T_A - 70^\circ C) & \\ \text{for } +70^\circ C < T_A \leq +125^\circ C \end{cases}$$

After determining the allowable package dissipation calculate the maximum output current using the following formula:

$$I_{OUT(MAX)} \cong \frac{P_D}{V_{IN} - V_{OUT}} \leq 400mA$$

Dual Mode is a trademark of Maxim Integrated Products, Inc.

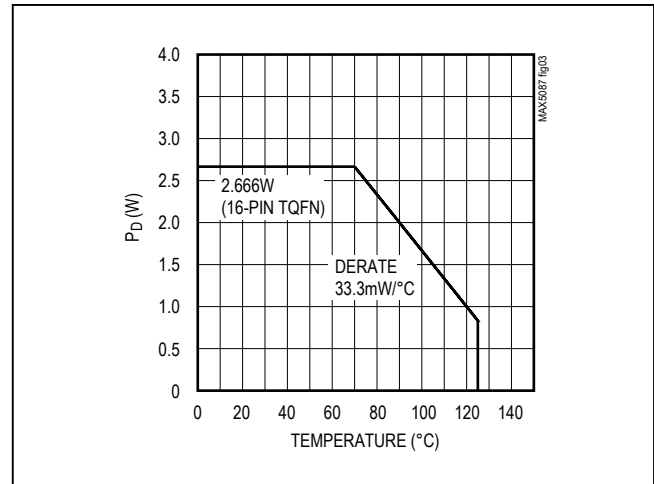

Figure 3. Calculated Maximum Power Dissipation vs. Temperature

The above equations do not include the negligible power dissipation from self-heating due to the IC ground current.

Example 1:

- $T_A = +95^\circ C$
- $V_{IN} = +14V$
- $V_{OUT} = +5V$

Find the maximum allowable output current. First calculate package dissipation at the given temperature as follows:

$$P_D = 2.666W - 0.0333 \frac{W}{^\circ C} (95^\circ C - 70^\circ C) = 1.8335W$$

Then determine the maximum output current:

$$I_{OUT(MAX)} = \frac{(1.8335W)}{(14V) - (5V)} = 203mA$$

Example 2:

- $T_A = +125^\circ C$
- $V_{IN} = +14V$
- $V_{OUT} = +5V$

Calculate package dissipation at the given temperature as follows:

$$P = 2.666W - 0.0333 \frac{W}{^{\circ}C} (125^{\circ}C - 70^{\circ}C) = 0.8345W$$

And establish the maximum current:

$$I_{OUT(MAX)} = \frac{(1.191W)}{(14V) - (5V)} = 92.7mA$$

Example 3:

$T_A = +50^{\circ}C$

$V_{IN} = +14V$

$V_{OUT} = +10V$

Calculate package dissipation at the given temperature as follows:

$$P_D = 2.666W$$

And find the maximum output current:

$$I_{OUT(MAX)} = \frac{(2.666W)}{(14V) - (10V)} = 666mA \Rightarrow I_{OUT(MAX)} = 400mA$$

In example 3 the maximum output current is calculated as 666mA, however, the maximum output current cannot exceed 400mA.

Use [Figure 4](#) to quickly determine maximum allowable output current for selected ambient temperatures.

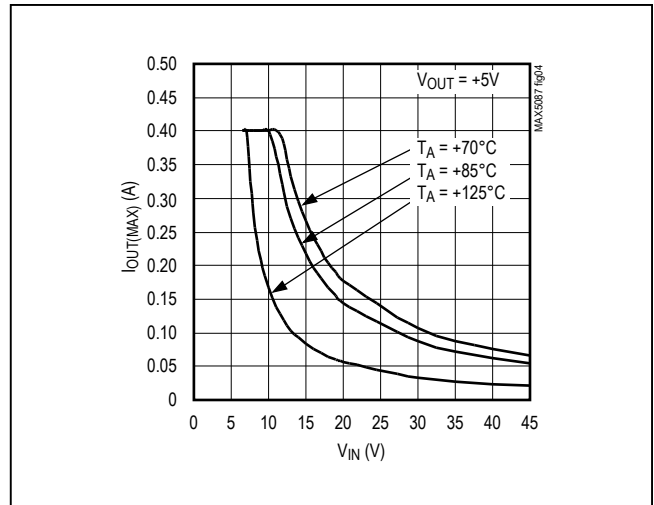

Figure 4. Maximum Output Current vs. Input Voltage (16-Pin TQFN)

Output-Capacitor Selection and Regulator Stability

For stable operation over the full temperature range and with load currents up to 400mA, use a 15µF (min) output capacitor with an ESR < 0.25Ω. To reduce noise and improve load-transient response, stability, and power-supply rejection use larger output capacitor values such as 22µF.

Some ceramic capacitor dielectrics exhibit large capacitance and ESR variation with temperature. For capacitor dielectrics such as Y5V, use 22µF or more to ensure stability at temperatures below -10°C. With X7R or X5R dielectrics, 15µF should be sufficient at all operating temperatures. To improve power supply rejection and transient response, use a minimum 47µF low-ESR capacitor from IN to GND.

MAX5087

45V, 400mA, Low-Quiescent-Current Linear Regulator with Adjustable Reset Delay

Chip Information

PROCESS: BICMOS

Package Information

For the latest package outline information and land patterns (footprints), go to www.maximintegrated.com/packages. Note that a "+", "#", or "-" in the package code indicates RoHS status only. Package drawings may show a different suffix character, but the drawing pertains to the package regardless of RoHS status.

PACKAGE TYPE	PACKAGE CODE	OUTLINE NO.	LAND PATTERN NO.
16 TQFN-EP	T1655+3	21-0140	90-0073

Revision History

REVISION NUMBER	REVISION DATE	DESCRIPTION	PAGES CHANGED
0	2/06	Initial release	—
1	4/06	Updated <i>Ordering Information</i> and <i>Electrical Characteristics</i> tables.	1–3
2	7/06	Updated <i>Electrical Characteristics</i> table.	2
3	2/08	Corrected errors in data sheet, reduced operating range, and removed products from <i>Ordering Information</i> table.	1–13
4	4/13	Added <i>IV</i> variant to <i>Ordering Information</i>	1
5	7/13	Changed package code to T1655+3	11
6	5/14	Updated <i>Applications</i> .	1

For pricing, delivery, and ordering information, please contact Maxim Direct at 1-888-629-4642, or visit Maxim Integrated's website at www.maximintegrated.com.

Maxim Integrated cannot assume responsibility for use of any circuitry other than circuitry entirely embodied in a Maxim Integrated product. No circuit patent licenses are implied. Maxim Integrated reserves the right to change the circuitry and specifications without notice at any time. The parametric values (min and max limits) shown in the *Electrical Characteristics* table are guaranteed. Other parametric values quoted in this data sheet are provided for guidance.