

**Pushbutton Switches, 22mm, Oil-Tight, Round**

**FEATURES**

- Fits 7/8" (22mm) diameter holes
- Full size buttons
- Meets NEMA 1, 12 and 13
- Rugged heavy-duty metal bushing, or thermoplastic bushings for full installation
- Matte black beveled frame finish
- IP65 protection level
- Snap-block contacts
- 6A @ 600VAC, 6A @ 125VDC V40, V50, F40, F50  
6A @ 600VAC, 4A @ 125VDC VAO, VRO, FAO, FRO
- Easy "no tool" mounting
- Choice of screw terminals or dual .110/.250 quick connects
- Double-break silver contacts standard, gold plated optional
- Stackable

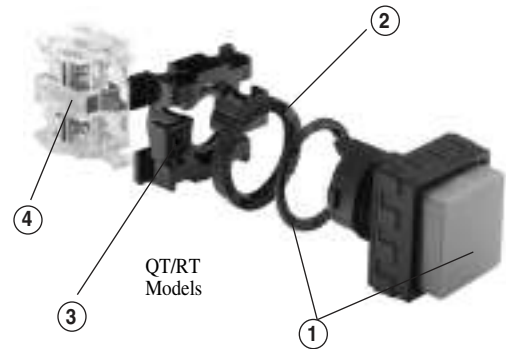
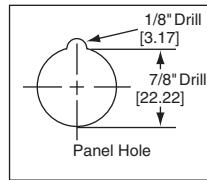
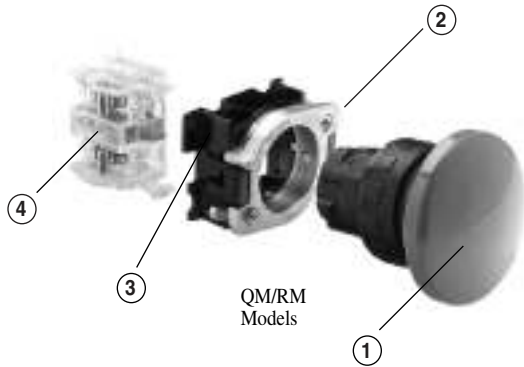

**INSTALLATION & ASSEMBLY**

- Engage the operator (1) into the 22.5mm dia. mounting hole.
- Engage metal ring (2) with operator (bayonet lock). Tighten set screws against back of panel.
- Snap the contact blocks (4) on the support(3).
- Snap the support (3) complete with contact blocks (4) on the metal ring (2).

- Engage the operator and seal (1) into the 22.5mm dia. mounting hole.
- Mount back-up nut (2) on bushing and then tighten against panel.
- Snap the contact blocks (4) on the support (3).
- Snap the support (3) complete the contact blocks (4) onto operator (1).

**MOMENTARY**

**Metal Bushings**

Contact blocks not supplied, order separately.  
(See page I8.)

Model	Type
RM010(*)	Flush Button
RM020(*)	Extended Button
RM015(*)	Extended Guard

(\*) Specify color by adding suffix number:  
(0) Black, (2) Red, (4) Yellow, (5) Green, (6) Blue, (8) Grey, (9) White.  
**Note: Front beveled frame is black.**

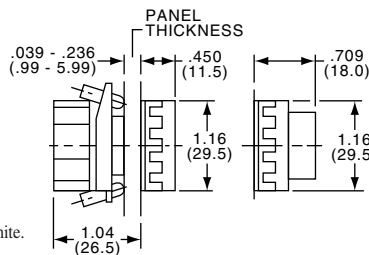

**Thermoplastic Bushings (Threaded)**

Contact blocks not supplied, order separately.  
(See page I8.)

Model	Type
RT010(*)	Flush Button
RT020(*)	Extended Button

(\*) Specify color by adding suffix number:  
(0) Black, (2) Red, (4) Yellow, (5) Green, (6) Blue, (8) Grey, (9) White.  
**Note: Front beveled frame is black.**

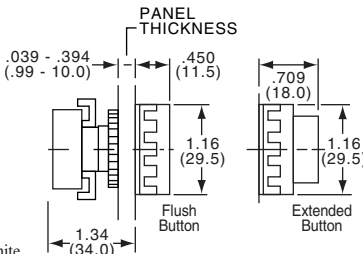

**Pushbutton Switches, 22mm, Oil-Tight, Round or Mushroom or Dual Button**



RM0502

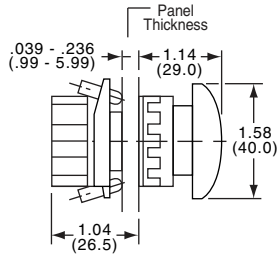

**MOMENTARY**

**Mushroom**

Contact blocks not supplied, order separately. (See page I8.)

Tyco Electronics	Alcoswitch	Type	Bushing
3-1437614-7	RM0502	Mushroom, Red	Metal, Bayonet
1437615-2	RT0502	Mushroom, Red	Thermoplastic, Threaded Bushing
3-1437614-6	RM0500	Mushroom, Black	Metal, Bayonet
1437615-1	RT0500	Mushroom, Black	Thermoplastic, Threaded Bushing
3-1437614-9	RM0552	Mushroom, Red	Metal, Bayonet (Wobble)
	RT050(*)	Mushroom	

(\*) Specify color by adding suffix number:

(0) Black, (2) Red, (4) Yellow, (5) Green, (6) Blue.

**Note: Front beveled frame is black.**



RM0652

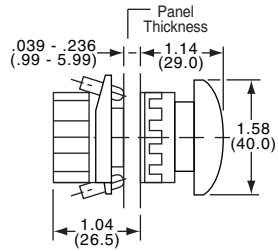

**PUSH-TO-LOCK, TWIST-RELEASE**

**Metal Bushings**

Contact blocks not supplied, order separately. (See page I8.)

Note: Use F40/V40 for N.C. contacts, and FAO/VAO for N.O. contacts.

Tyco Electronics	Alcoswitch	Type	Arrow
4-1437614-0	RM0652	Mushroom, Red	White

**Note: Front beveled frame is black.**



RM030(\*)

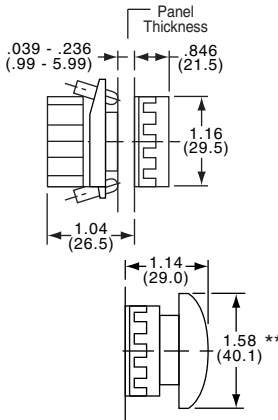

**MAINTAINED**

Contact blocks not supplied, order separately. (See page I8.)

Note: Use F40/V40 for N.C. contacts and FAO/VAO for N.O. contacts.

Tyco Electronics	Alcoswitch	Type
—	RM030(*)	Flush Button
3-1437614-4	RM0450	Mushroom, Black
3-1437614-5	RM0452	Mushroom, Red
3-1437614-8	RM0532	Push-Pull, Mushroom, Red

(\*) Specify color by adding suffix number:

(0) Black, (2) Red, (4) Yellow, (5) Green, (6) Blue, (8) Grey, (9) White.

**Note: Front beveled frame is black.**

**\*\* Note: RM0532 mushroom 35mm Dia. (1.38)**



QT01201

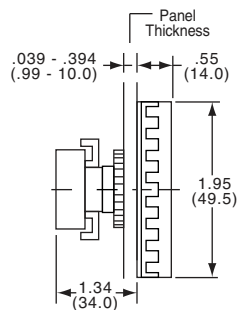

**MOMENTARY DUAL OPERATOR\***

**Threaded Thermoplastic bushing**

Contact blocks not supplied, order separately. (See page I8.)

Black buttons available.

Tyco Electronics	Alcoswitch	Color	Legend
1437614-9	QT01201	Green, Red	As Shown
—	QT012STSTH	Green, Red	Start & Stop Horizontal

\*Not oil tight construction, not sealed; meets NEMA 1 only.

**Note: Front beveled frame is black.**

**Pushbutton or Keylock or Selector Switches, 22mm, Oil-Tight**

**MOMENTARY**

**Metal Bushings**

Contact blocks not supplied, order separately. (See page I8.)

Model	Type
QM010(*)	Flush Button
QM020(*)	Extended Button

(\*) Specify color by adding suffix number:

(0) Black, (2) Red, (4) Yellow, (5) Green, (6) Blue, (8) Grey, (9) White.

**Note: Front beveled frame is black.**

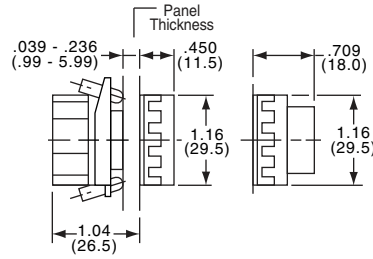

QM010(\*)

**Thermoplastic Bushings (Threaded)**

Contact blocks not supplied, order separately. (See page I8.)

Model	Type
QT010(*)	Flush Button
QT020(*)	Extended Button

(\*) Specify color by adding suffix number:

(0) Black, (2) Red, (4) Yellow, (5) Green, (6) Blue, (8) Grey, (9) White.

**Note: Front beveled frame is black.**

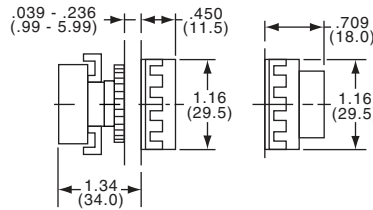

QT010(\*)

**2 POSITION SELECTORS/KEYLOCK MAINTAINED**

**Metal Bushings**

Contact blocks not supplied, order separately. (See page I8.)

Tyco Electronics	Alcoswitch	Action	Throw	CAM	Remove Key
7-1437614-7	RM4040	Maintained, Black	120°	1	Long Selector
7-1437614-0	RM3040	Maintained, Black	120°	1	Selector
5-1437614-4	RM200	Maintained	60°	1	⊙
5-1437614-5	RM201	Maintained	60°	1	⊗
6-1437614-5	RM250	Momentary, Right	60°	1	⊙
5-1437614-6	RM204	Maintained	120°	1	⊗
5-1437614-7	RM205	Maintained	120°	1	⊗
1437614-1	E1	Spare Key			

**Note: Front beveled frame is black.**

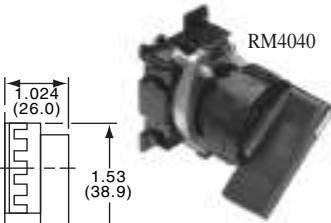
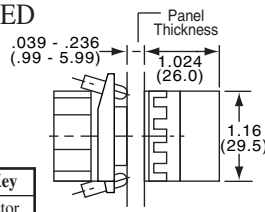

RM4040



RM3040



RM200/201 with/2 keys

**3 POSITION SELECTORS**

**Short Handle, Metal Bushings**

Contact blocks not supplied, order separately. (See page I8.)

Tyco Electronics	Alcoswitch	Action	CAM	Tyco Electronics	Alcoswitch	Action	CAM
7-1437614-1	RM3100	Maintained, Black	2	7-1437614-4	RM3700	Momentary, Right Side, Black	2
7-1437614-2	RM3120	Maintained, Black	3	7-1437614-5	RM3800	Double Momentary, Black	2
7-1437614-3	RM3130	Maintained, Black	4	7-1437614-6	RM3830	Double Momentary, Black	4

**Note: Front beveled frame is black.**

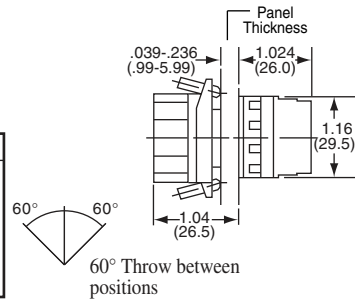

RM3100

**Long Handle, Metal Bushings**

Contact blocks not supplied, order separately. (See page I8.)

Tyco Electronics	Alcoswitch	Action	CAM	Tyco Electronics	Alcoswitch	Action	CAM
7-1437614-8	RM4100	Maintained	2	—	RM4700	Momentary, Right Side	2
—	RM4120	Maintained	3	7-1437614-9	RM4800	Double Momentary	2
—	RM4130	Maintained	4				

**Note: Front beveled frame is black.**

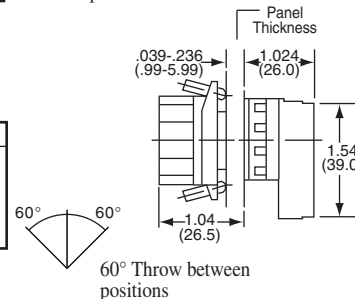

RM4100

**Keylock or Pushbutton Switches, 22mm, Oil-Tight or Pilot Lights**

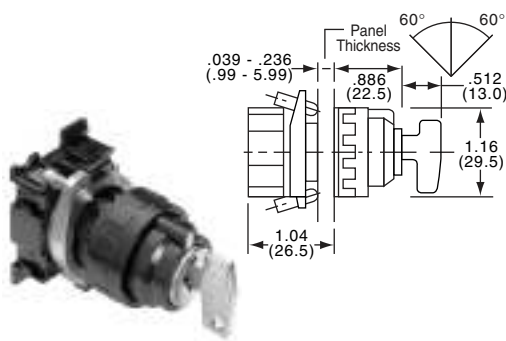

Supplied with 2 keys

**3 POSITION KEYLOCK SELECTOR  
MAINTAINED OR MOMENTARY**

**Metal Bushings**

Contact blocks not supplied, order separately. (See page I8.)

Tyco Electronics	Alcoswitch	Action	CAM	Remove Key	Tyco Electronics	Alcoswitch	Action	CAM	Remove Key
5-1437614-8	RM210	Maintained	2	⊙	6-1437614-4	RM243	Maintained	4	⊙
5-1437614-9	RM220	Maintained	2	⊙	6-1437614-6	RM270	Mom. Right Side	2	⊙
6-1437614-0	RM222	Maintained	3	⊙	6-1437614-7	RM272	Mom. Right Side	3	⊙
6-1437614-1	RM230	Maintained	2	⊙	6-1437614-8	RM273	Mom. Right Side	4	⊙
6-1437614-2	RM232	Maintained	3	⊙	6-1437614-9	RM280	Mom. Both Sides	2	⊙
6-1437614-3	RM233	Maintained	4	⊙	1437614-1	E1	Spare Key		⊙
—	RM240	Maintained	2	⊙					

Note: Front beveled frame is black.



QM600 (RM600)

Metal Bushing



SR601 Threaded Thermoplastic Bushing Front lamp

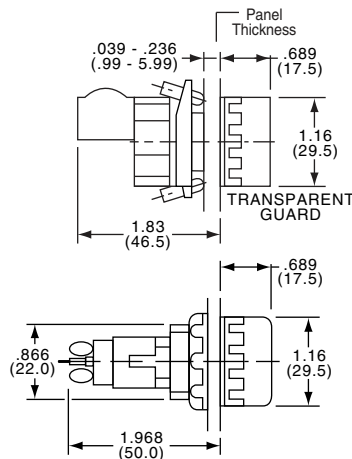

**PILOT LIGHTS (FULL VOLTAGE TYPE)**

Lamps: order separately, miniature bayonet base. (See page I15.)

Lamps: use G3 1/2 on QM600(\*), use T3 1/4 on SR601(\*), RM600(\*). Custom legends available.

Model	Type
QM600(*)	Square pilot light, metal bushing
SR601(*)	Round pilot light, plastic bushing screw turn
RM600(*)	Round pilot light, metal bushing

(\*) Specify color by adding suffix number: (2) Red, (3) Orange, (4) Yellow, (5) Green, (6) Blue, (9) White.

Reliant'22

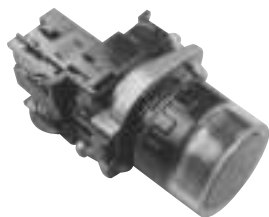

RM120(\*)

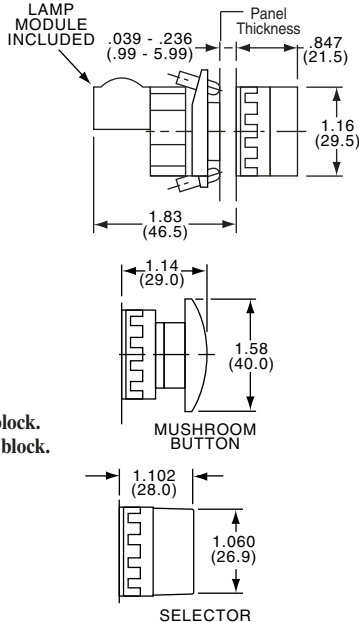

**Application Note:**  
+V40/F40 used for N.C contact block.  
+VA0/FA0 used for N.O. contact block.

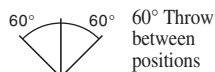

**ILLUMINATED/ROUND MOMENTARY/MAINTAINED**

**Metal Bushing**

Contact blocks not supplied, order separately. (See page I8.)

Lamp circuit isolated. Order lamp separately. (See page I15.)

Lamps: Use T-3 1/4 or G3 1/2 incandescent or neon lamps.

Tyco Electronics	Alcoswitch	Action	Type	Cam Type
—	RM120(*)	Momentary	Extended Button	
—	RM122(*)	Momentary	Guarded Button	
—	+RM130(*)	Maintained	Flush Button	} Push-On - Push-Off See Application Note
—	+RM145(*)	Maintained	Mushroom	
—	RM150(*)	Momentary	Mushroom	
5-1437614-3	RM1652	Twist Release	Mushroom, Red	
<b>Illuminated Selectors</b>				
—	RM650(*)	Maintained	2-Pos. Selector**1	
—	RM653(*)	Maintained	3-Pos. Selector**2	

When operating from line voltage use step down transformers 5B0 or 570. (See page I15.)  
(\*) Specify color by adding suffix number: (2) Red, (4) Yellow, (5) Green, (6) Blue, (9) White.

Note: RM145 and RM150 available only in red, yellow, green.

\*\*Use G3 1/2 lamps only.

Note: Front beveled frame is black.

**Pushbutton Switches, 22mm, Oil-Tight, Round or Square Buttons**

**SQUARE, MOMENTARY ILLUMINATED**

Metal Bushing

Contact blocks not supplied, order separately. (See page I8.)

Lamp circuit isolated. Order lamps separately.

Lamps: Use G3 1/2. (See page I15.)

Custom legends available.

Model	Type
QM122(*)	Flush Button
QM120(*)	Extended Button

When operating from line voltage use step down transformers 5B0 or 570. (See page I15.)

(\*) Specify color by adding suffix number: (2) Red, (4) Yellow, (5) Green, (6) Blue, (9) White.

Note: Front beveled frame is black.

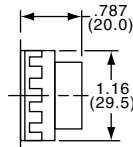
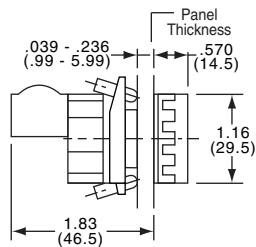

QM122(\*)



QM120(\*)

**ROUND, MOMENTARY ILLUMINATED**

Thermoplastic

Contact blocks not supplied, order separately. (See page I8.)

Lamp circuit isolated. Order lamps separately. (See page I15.)

Lamps: use T-3 1/4 or G3 1/2 incandescent or neon lamps.

Model	Action	Type
RT120(*)	Momentary	Extended Button

When operating from line voltage use step down transformers 5B0 or 570. (See page I15.)

(\*) Specify color by adding suffix number: (2) Red, (4) Yellow, (5) Green, (6) Blue, (9) White.

Note: Front beveled frame is black.

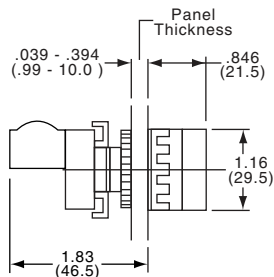

RT120(\*)

Reliant'22