

RoHS

REV.	DESCRIPTION	DATE
A		2016.04.12
B	Add Dim. 'F' Dim. 'F'	2019.04.09
	Tolerance Change	2019.08.12

MATERIAL&FINISH

Insulator: PBT Glass Fiber (UL94V-0)
 Contact Material: Terminal Brass.
 Shell Spcc.
 Contact Plating : Terminal Gold-Plated Over Nickel.
 Shell Nickel OR TIN.

SPECIFICATIONS

Current Rating :1A AC, DC
 Voltage Rating : 250V AC, DC
 Temperature Range: -40 ° C To+105 ° C
 Contact Resistance : 20MΩ Max
 Insulation Resistance :1000MΩ Min
 Withstanding Voltage:500V AC/Min

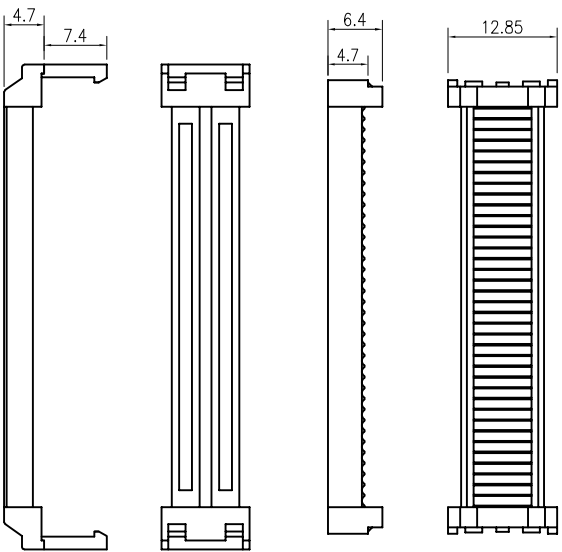
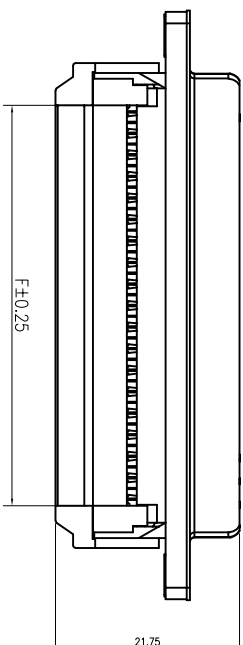
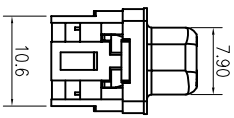
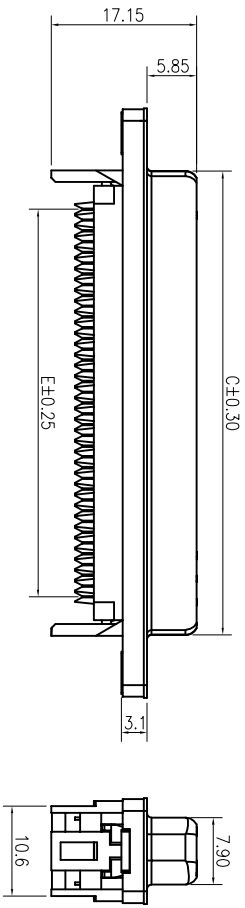
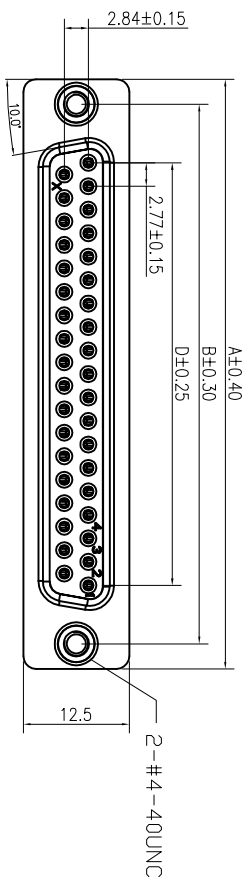

NUMBER OF POSITIONS	DIMENSION					
	A	B	C	D	E	F
9	30.80	25.00	16.35	11.08	10.16	11.68
15	39.14	33.30	24.75	19.39	17.78	19.30
25	53.05	47.04	38.35	33.24	30.48	32.00
37	69.32	63.50	54.75	49.86	45.72	47.24

CnC Tech, LLC

Part NO.

410F0-XX-1-004S

UNLESS TOLERANCE		DRAW BY
GENERAL	ANGLE	DESIGN BY
X. ± 0.38	X.° ± 3.0°	CHECK BY
.X ± 0.30	.X° ± 2.0°	APPROVE BY
.XX ± 0.25	.XX° ± 1.0°	
.XXX ± 0.10	.XXX° ± 0.5°	

SCALE	SHEET	UNIT
1:1	1/1	MM

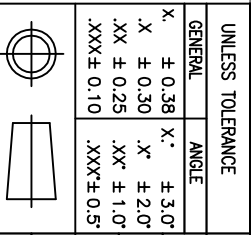
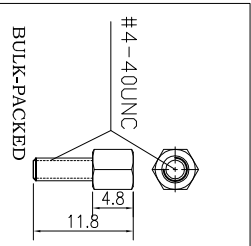

SCALE	SHEET	UNIT
1:1	1/1	MM

DRW. NO.	REV.
	C