

CLC5622

Dual, High Output, Video Amplifier

General Description

The National CLC5622 has a new output stage that delivers high output drive current (130mA), but consumes minimal quiescent supply current (3.0mA/ch) from a single 5V supply. Its current feedback architecture, fabricated in an advanced complementary bipolar process, maintains consistent performance over a wide range of gains and signal levels, and has a linear phase response up to one half of the -3dB frequency.

The CLC5622 offers 0.1dB gain flatness to 30MHz and differential gain and phase errors of 0.05% and 0.02°. These features are ideal for professional and consumer video applications.

The CLC5622 offers superior dynamic performance with a 160MHz small-signal bandwidth, 370V/μs slew rate and 4.4ns rise/fall times (2V_{STEP}). The combination of low quiescent power, high output current drive, and high speed performance make the CLC5622 well suited for many battery powered personal communication/computing systems.

The ability to drive low impedance, highly capacitive loads, makes the CLC5622 ideal for single ended cable applications. It also drives low impedance loads with minimum distortion. The CLC5622 will drive a 100Ω load with only -95/-95dBc second/third harmonic distortion (A_V = +2, V_{OUT} = 2V_{PP}, f = 1MHz). With a 25Ω load, and the same conditions, it produces only -72/-77dBc second/third harmonic distortion.

The CLC5622 can also be used for driving differential-input step-up transformers for applications such as Asynchronous Digital Subscriber Lines (ADSL) or High-Bit-Rate Digital Subscriber Lines (HDSL).

When driving the input of high resolution A/D converters, the CLC5622 provides excellent -90/-97dBc second/third harmonic distortion (A_V = +2, V_{OUT} = 2V_{PP}, f = 1MHz, R_L = 1kΩ) and fast settling time.

Features

- 130mA output current
- 0.05%, 0.03° differential gain, phase
- 3.0mA/ch supply current
- 160MHz bandwidth (A_V = +2)
- -90/-97dBc HD2/HD3 (1MHz)
- 18ns settling to 0.05%
- 370V/μs slew rate
- Stable for capacitive loads up to 1000pf
- Single 5V or ±5V supplies

Applications

- Video line driver
- ADSL/HDSL driver
- Coaxial cable driver
- UTP differential line driver
- Transformer/coil driver
- High capacitive load driver
- Portable/battery powered applications
- Differential A/D driver

Maximum Output Voltage vs. R_L

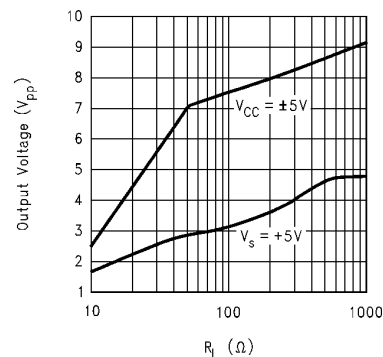

01500201

Connection Diagram

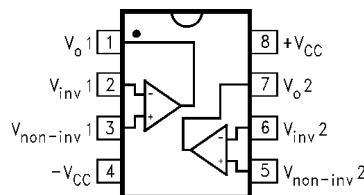

**Pinout
DIP & SOIC**

01500203

Typical Application

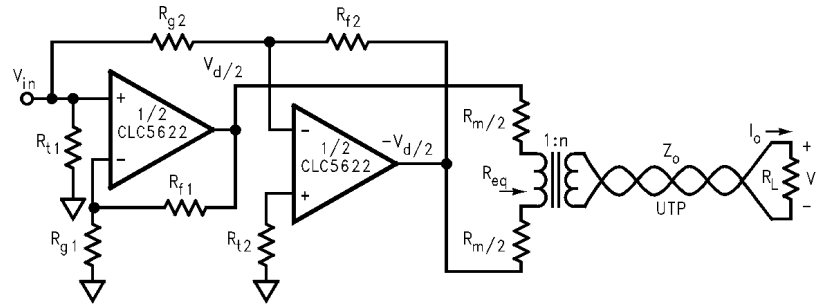

01500202

Differential Line Driver with Load Impedance Conversion

Ordering Information

THE FOLLOWING DEVICES WERE OBSOLETE IN MARCH 2003

Package	Temperature Range Industrial	Part Number	Package Marking	NSC Drawing
8-pin plastic DIP	-40°C to +85°C	CLC5622IN	CLC5622IN	N08E
8-pin plastic SOIC	-40°C to +85°C	CLC5622IM	CLC5622IM	M08A
		CLC5622IMX	CLC5622IM	

Absolute Maximum Ratings (Note 1)

If Military/Aerospace specified devices are required, please contact the National Semiconductor Sales Office/Distributors for availability and specifications.

Supply Voltage ($V_{CC}-V_{EE}$)	+14V
Output Current (See note 4)	140mA
Common-Mode Input Voltage	V_{EE} to V_{CC}
Maximum Junction Temperature	+150°C
Storage Temperature Range	-65°C to +150°C

Lead Temperature (soldering 10 sec)	+300°C
ESD (Human Body Model)	1000V

Operating Ratings

Thermal Resistance		
Package	(θ_{JC})	(θ_{JA})
MDIP	65°C/W	130°C/W
SOIC	50°C/W	145°C/W

+5V Electrical Characteristics

($A_V = +2$, $R_f = 750\Omega$, $R_L = 100\Omega$, $V_S = +5V$ (Note 5), $V_{CM} = V_{EE} + (V_S/2)$, R_L tied to V_{CM} , unless specified)

Symbol	Parameter	Conditions	Typ	Min/Max Ratings (Note 2)			Units
	Ambient Temperature	CLC5622IN/IM	+25°C	+25°C	0 to 70°C	-40 to 85°C	
Frequency Domain Response							
	-3dB Bandwidth	$V_O = 0.5V_{PP}$	130	100	90	85	MHz
		$V_O = 2.0V_{PP}$	95	80	77	75	MHz
	-0.1dB Bandwidth	$V_O = 0.5V_{PP}$	30	25	20	20	MHz
	Gain Peaking	<200MHz, $V_O = 0.5V_{PP}$	0	0.5	0.9	1.3	dB
	Gain Roll-off	<30MHz, $V_O = 0.5V_{PP}$	0.1	0.4	0.6	0.6	dB
	Linear Phase Deviation	<30MHz, $V_O = 0.5V_{PP}$	0.15	0.3	0.4	0.4	deg
	Differential Gain	NTSC, $R_L = 150\Omega$ to -1V	0.03	-	-	-	%
	Differential Phase	NTSC, $R_L = 150\Omega$ to -1V	0.07	-	-	-	deg
Time Domain Response							
	Rise and Fall Time	2V Step	4.5	6.0	6.4	6.8	ns
	Settling Time to 0.05%	1V Step	17	25	40	60	ns
	Overshoot	2V Step	11	15	18	18	%
	Slew Rate	2V Step	280	195	165	150	V/ μ s
Distortion And Noise Response							
	2nd Harmonic Distortion	$2V_{PP}, 1MHz$	-79	-76	-73	-73	dBc
		$2V_{PP}, 1MHz; R_L = 1k\Omega$	-80	-78	-75	-75	dBc
		$2V_{PP}, 5MHz$	-66	-60	-58	-58	dBc
	3rd Harmonic Distortion	$2V_{PP}, 1MHz$	-85	-82	-79	-79	dBc
		$2V_{PP}, 1MHz; R_L = 1k\Omega$	-83	-81	-78	-78	dBc
		$2V_{PP}, 5MHz$	-65	-62	-60	-60	dBc
	Equivalent Input Noise						
	Voltage (e_{ni})	>1MHz	3.4	4.4	4.9	4.9	nV/ \sqrt{Hz}
	Non-Inverting Current (i_{bn})	>1MHz	6.3	8.2	9.0	9.0	pA/ \sqrt{Hz}
	Inverting Current (i_{bn})	>1MHz	8.7	11.3	12.4	12.4	pA/ \sqrt{Hz}
	Crosstalk (Input Referred)	10MHz, $1V_{PP}$	-72	-	-	-	dB
Static, DC Performance							
	Input Offset Voltage (Note 3)		1	4	6	6	mV
	Average Drift		8	-	-	-	μ V/°C
	Input Bias Current (Non-Inverting) (Note 3)		6	18	22	24	μ A
	Average Drift		40	-	-	-	nA/°C
	Input Bias Current (Inverting) (Note 3)		6	14	16	17	μ A
	Average Drift		25	-	-	-	nA/°C
	Power Supply Rejection Ratio	DC	48	45	43	43	dB

+5V Electrical Characteristics (Continued) $(A_V = +2, R_f = 750\Omega, R_L = 100\Omega, V_S = +5V \text{ (Note 5)}, V_{CM} = V_{EE} + (V_S/2), R_L \text{ tied to } V_{CM}, \text{ unless specified})$

Symbol	Parameter	Conditions	Typ	Min/Max Ratings (Note 2)			Units
	Common Mode Rejection Ratio	DC	47	45	43	43	dB
	Supply Current (Note 3)	$R_L = \infty$	3.0	3.4	3.6	3.6	mA
Miscellaneous Performance							
	Input Resistance (Non-Inverting)		0.36	0.26	0.23	0.23	M Ω
	Input Capacitance (Non-Inverting)		1.8	2.75	2.75	2.75	pF
	Input Voltage Range, High		4.2	4.1	4.1	4.0	V
	Input Voltage Range, Low		0.8	0.9	0.9	1.0	V
	Output Voltage Range, High	$R_L = 100\Omega$	4.0	3.9	3.9	3.8	V
	Output Voltage Range, Low	$R_L = 100\Omega$	1.0	1.1	1.1	1.2	V
	Output Voltage Range, High	$R_L = \infty$	4.1	4.0	4.0	3.9	V
	Output Voltage Range, Low	$R_L = \infty$	0.9	1.0	1.0	1.1	V
	Output Current (Note 4)		100	80	65	40	mA
	Output Resistance, Closed Loop	DC	70	105	105	140	m Ω

 $\pm 5V$ Electrical Characteristics $(A_V = +2, R_f = 750\Omega, R_L = 100\Omega, V_{CM} = \pm 5V, \text{ Unless Specified})$

Symbol	Parameter	Conditions	Typ	Min/Max Ratings (Note 2)			Units
	Ambient Temperature	CLC5622IN/IM	+25°C	+25°C	0 to 70°C	-40 to 85°C	

Frequency Domain Response

	-3dB Bandwidth	$V_O = 1.0V_{PP}$	160	135	120	115	MHz
		$V_O = 4.0V_{PP}$	75	60	57	55	MHz
	-0.1dB Bandwidth	$V_O = 1.0V_{PP}$	30	25	20	20	MHz
	Gain Peaking	<200MHz, $V_O = 1.0V_{PP}$	0	1.5	0.9	1.3	dB
	Gain Roll-off	<30MHz, $V_O = 1.0V_{PP}$	0.1	0.2	0.3	0.3	dB
	Linear Phase Deviation	<30MHz, $V_O = 1.0V_{PP}$	0.15	0.3	0.4	0.4	deg
	Differential Gain	NTSC, $R_L = 150\Omega$	0.05	0.06	-	-	%
	Differential Phase	NTSC, $R_L = 150\Omega$	0.03	0.06	-	-	deg

Time Domain Response

	Rise and Fall Time	2V Step	4.4	5.8	6.2	6.8	ns
	Settling Time to 0.05%	2V Step	18	25	40	60	ns
	Overshoot	2V Step	19	21	23	24	%
	Slew Rate	2V Step	370	280	260	240	V/ μ s

Distortion And Noise Response

	2nd Harmonic Distortion	2V _{PP} , 1MHz	-95	-88	-385	-385	dBc
		2V _{PP} , 1MHz; $R_L = 1k\Omega$	-90	-88	-85	-85	dBc
		2V _{PP} , 5MHz	-74	-66	-64	-64	dBc
	3rd Harmonic Distortion	2V _{PP} , 1MHz	-95	-91	-88	-88	dBc
		2V _{PP} , 1MHz; $R_L = 1k\Omega$	-97	-93	-90	-90	dBc
		2V _{PP} , 5MHz	-73	-64	-62	-62	dBc
	Equivalent Input Noise						
	Voltage (e_{ni})	>1MHz	3.4	4.4	4.9	4.9	nV/ $\sqrt{\text{Hz}}$
	Non-Inverting Current (i_{bn})	>1MHz	6.3	8.2	9.0	9.0	pA/ $\sqrt{\text{Hz}}$
	Inverting Current (i_{bi})	>1MHz	8.7	11.3	12.4	12.4	pA/ $\sqrt{\text{Hz}}$
	Crosstalk (Input Referred)	10MHz, 1V _{PP}	-72	-	-	-	dB

Static, DC Performance

	Input Offset Voltage		1	6	7	8	mV
--	----------------------	--	---	---	---	---	----

±5V Electrical Characteristics (Continued) $(A_V = +2, R_f = 750\Omega, R_L = 100\Omega, V_{CM} = \pm 5V, \text{ Unless Specified})$

Symbol	Parameter	Conditions	Typ	Min/Max Ratings (Note 2)			Units
	Average Drift		10	–	–	–	$\mu V/^{\circ}C$
	Input Bias Current (Non-Inverting)		8	18	23	25	μA
	Average Drift		40	–	–	–	$nA/^{\circ}C$
	Input Bias Current (Inverting)		9	24	28	28	μA
	Average Drift		30	–	–	–	$nA/^{\circ}C$
	Power Supply Rejection Ratio	DC	48	45	43	43	dB
	Common Mode Rejection Ratio	DC	48	46	44	44	dB
	Supply Current (Per Channel)	$R_L = \infty$	3.2	3.8	4.0	4.0	mA
Miscellaneous Performance							
	Input Resistance (Non-Inverting)		0.48	0.34	0.31	0.31	M Ω
	Input Capacitance (Non-Inverting)		1.45	2.15	2.15	2.15	pF
	Common-Mode Input Range		± 4.2	± 4.1	± 4.1	± 4.0	V
	Output Voltage Range	$R_L = 100\Omega$	± 3.8	± 3.6	± 3.6	± 3.5	V
	Output Voltage Range	$R_L = \infty$	± 4.0	± 3.8	± 3.8	± 3.7	V
	Output Current (Note 4)		130	100	80	50	mA
	Output Resistance, Closed Loop	DC	60	90	90	120	m Ω

Note 1: "Absolute Maximum Ratings" are those values beyond which the safety of the device cannot be guaranteed. They are not meant to imply that the devices should be operated at these limits. The table of "Electrical Characteristics" specifies conditions of device operation.

Note 2: Min/max ratings are based on product characterization and simulation. Individual parameters are tested as noted. Outgoing quality levels are determined from tested parameters.

Note 3: AJ-level: spec. is 100% tested at $+25^{\circ}C$.

Note 4: The short circuit current can exceed the maximum safe output current

Note 5: $V_S = V_{CC} - V_{EE}$

+5V Typical Performance Characteristics

$(A_V = +2, R_f = 750\Omega, R_L = 100\Omega, V_S = +5V \text{ (Note 5)}, V_{CM} = V_{EE} + (V_S/2), R_L \text{ tied to } V_{CM}, \text{ unless specified}).$

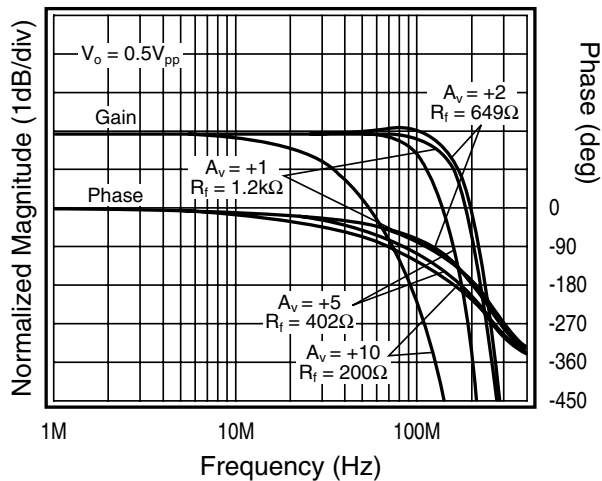
Non-Inverting Frequency Response

01500204

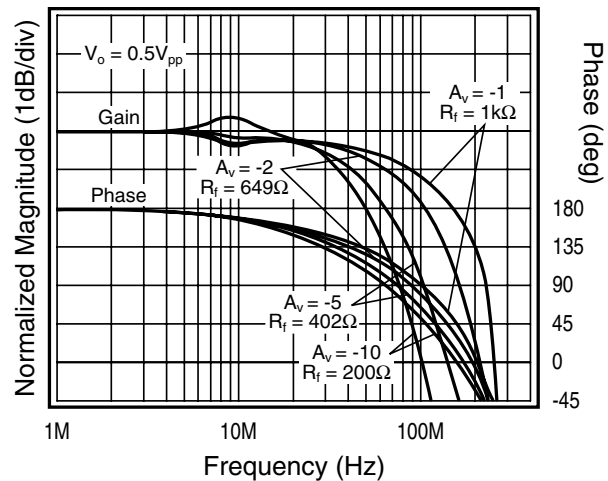
Inverting Frequency Response

01500205

+5V Typical Performance Characteristics ($A_V = +2$, $R_f = 750\Omega$, $R_L = 100\Omega$, $V_S = +5V$ (Note 5), $V_{CM} = V_{EE} + (V_S/2)$, R_L tied to V_{CM} , unless specified). (Continued)

Frequency Response vs. R_L

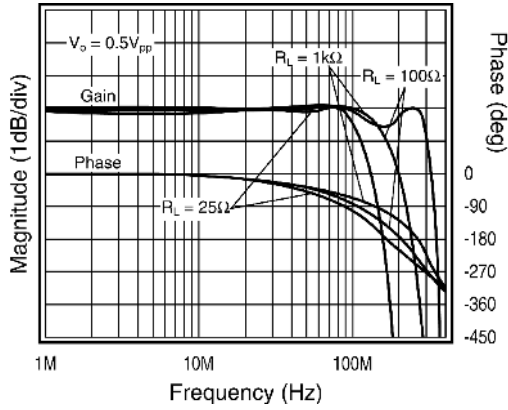

01500206

Frequency Response vs. V_O

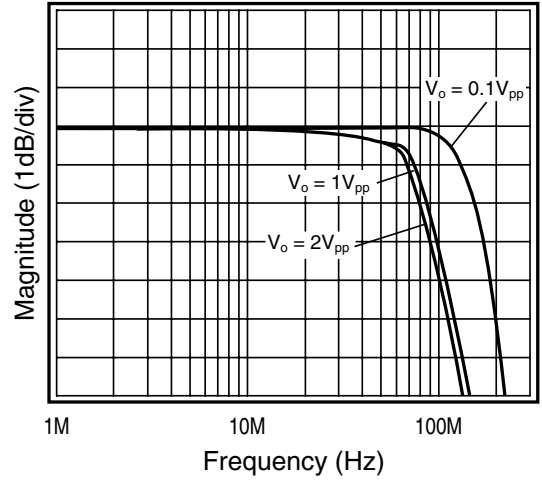

01500207

Gain Flatness & Linear Phase

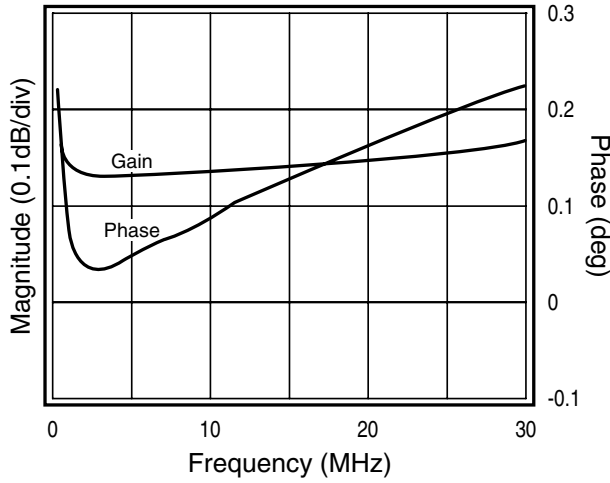

01500208

Open Loop Transimpedance Gain, $Z(s)$

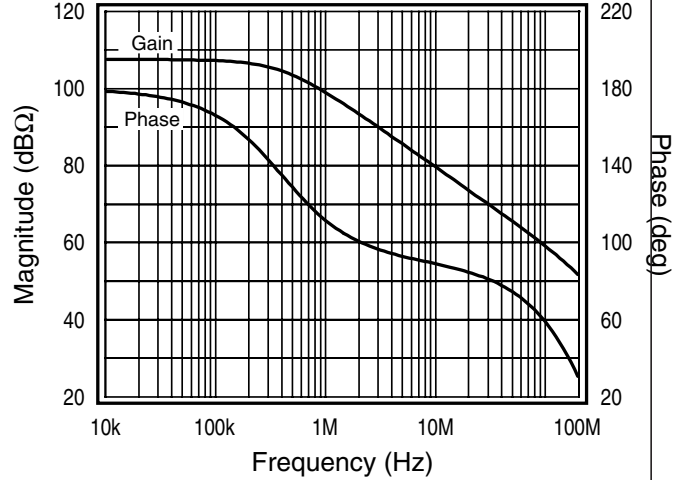

01500209

+5V Typical Performance Characteristics ($A_V = +2$, $R_f = 750\Omega$, $R_L = 100\Omega$, $V_S = +5V$ (Note 5), $V_{CM} = V_{EE} + (V_S/2)$, R_L tied to V_{CM} , unless specified). (Continued)

PSRR & CMRR

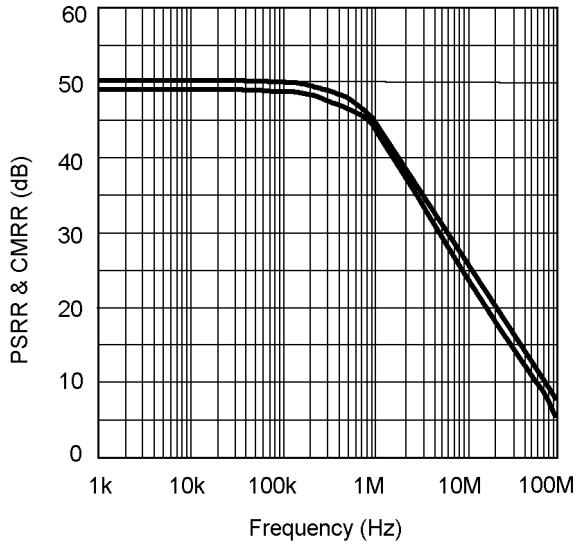

01500210

Equivalent Input Noise

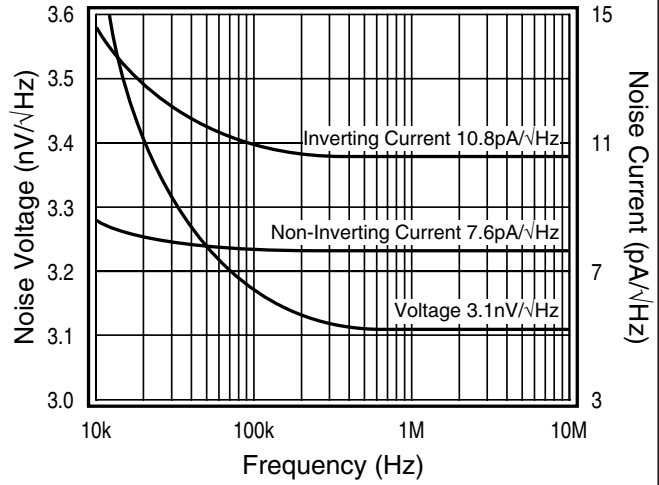

01500211

2nd & 3rd Harmonic Distortion

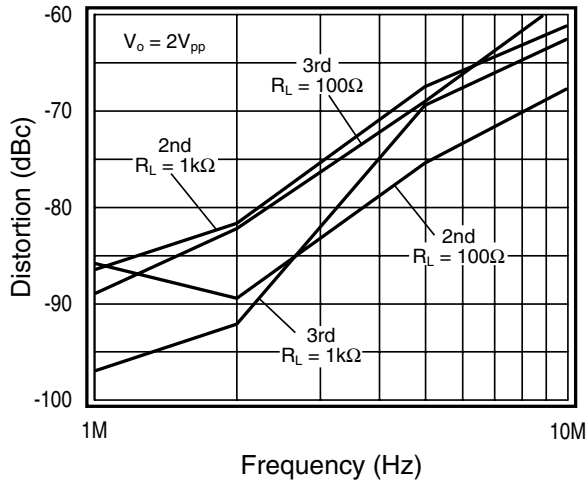

01500212

2nd & 3rd Harmonic Distortion, $R_L = 25\Omega$

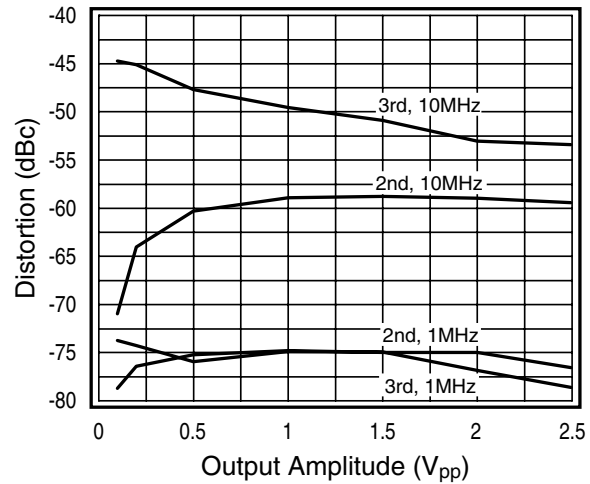

01500213

+5V Typical Performance Characteristics ($A_V = +2$, $R_f = 750\Omega$, $R_L = 100\Omega$, $V_S = +5V$ (Note 5), $V_{CM} = V_{EE} + (V_S/2)$, R_L tied to V_{CM} , unless specified). (Continued)

2nd & 3rd Harmonic Distortion, $R_L = 100\Omega$

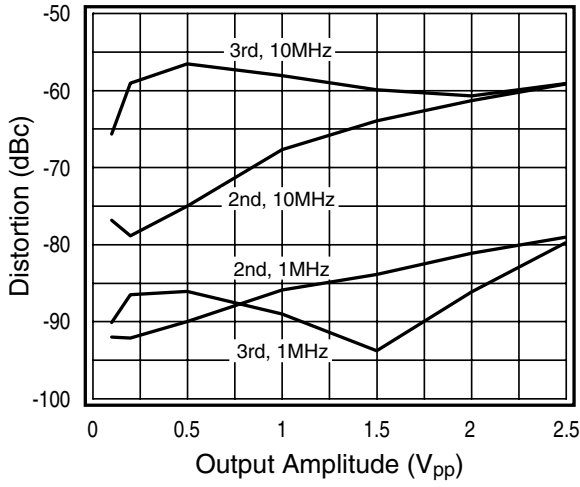

01500214

2nd & 3rd Harmonic Distortion, $R_L = 1k\Omega$

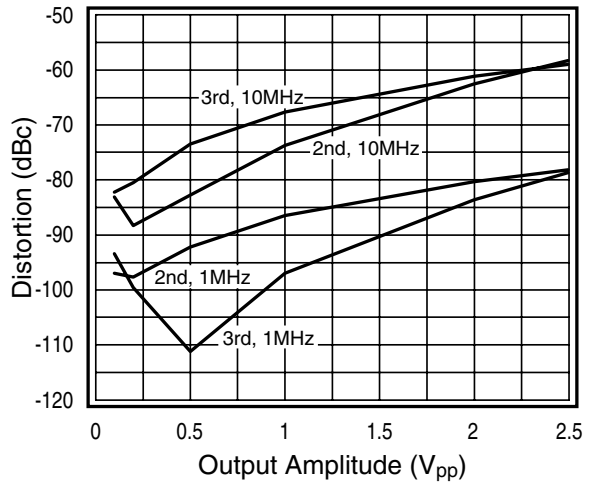

01500215

Large & Small Signal Pulse Response

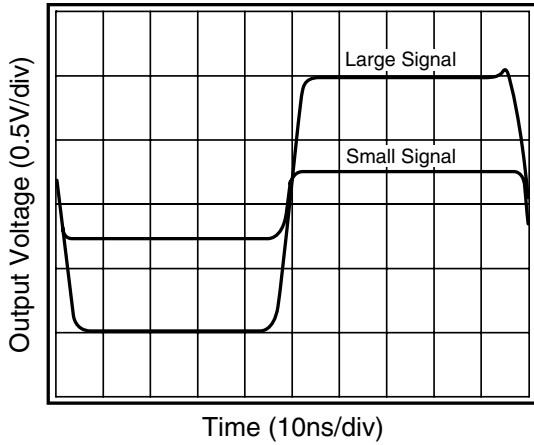

01500216

Output Impedance vs. Frequency

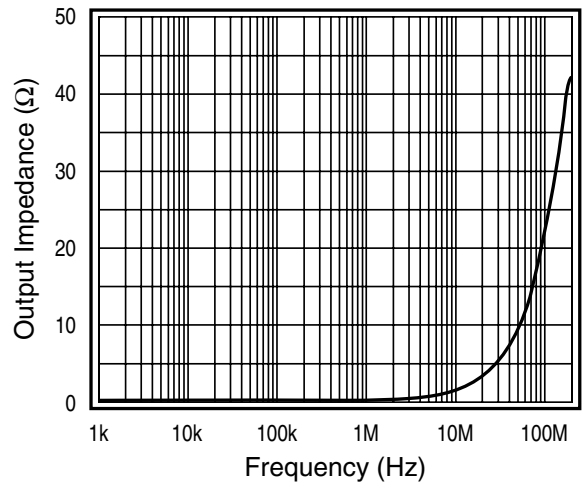

01500217

I_{BI} , I_{BN} , V_{IO} vs. Temperature

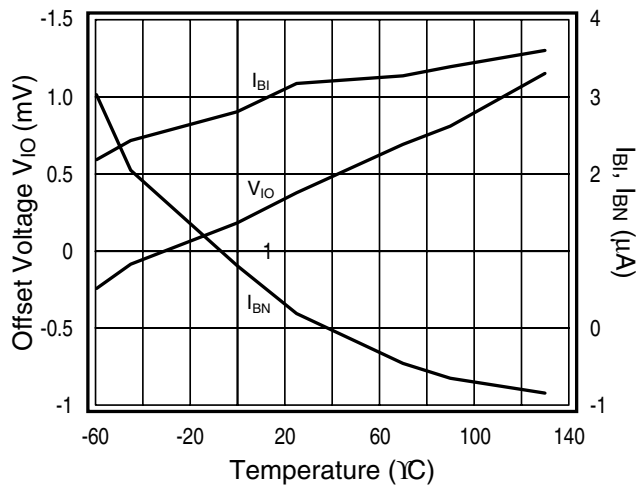

01500218

±5V Typical Performance

($A_v = +2$, $R_f = 750\Omega$, $R_L = 100\Omega$, $V_{CC} = \pm 5V$, unless specified)

Frequency Response

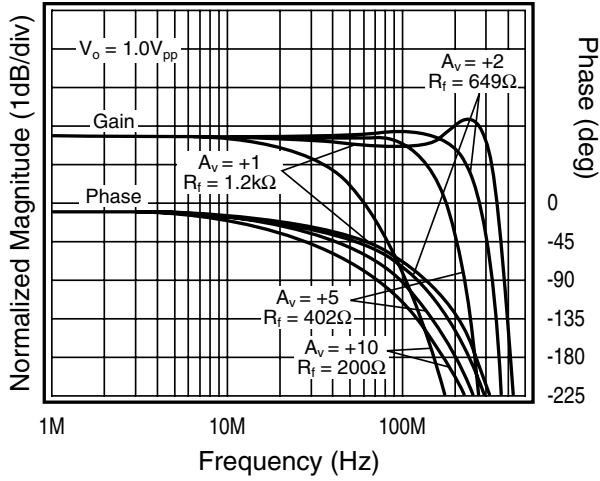

01500219

Inverting Frequency Response

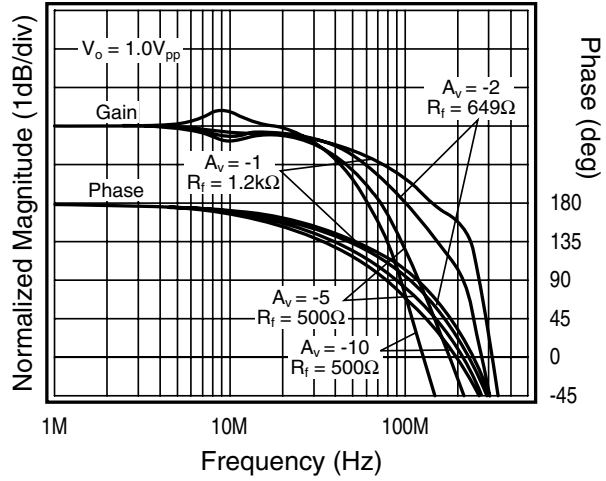

01500220

Frequency Response vs. R_L

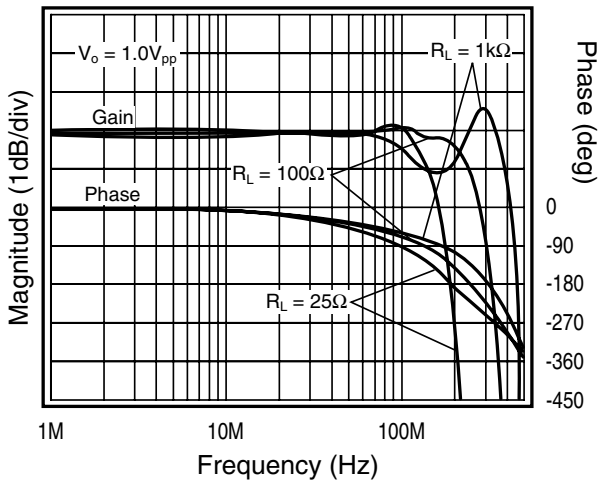

01500221

Frequency Response vs. V_o

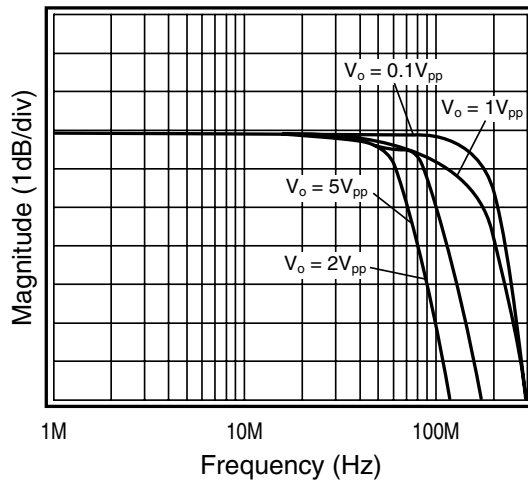

01500222

±5V Typical Performance ($A_v = +2$, $R_f = 750\Omega$, $R_L = 100\Omega$, $V_{CC} = \pm 5V$, unless specified) (Continued)

Gain Flatness & Linear Phase

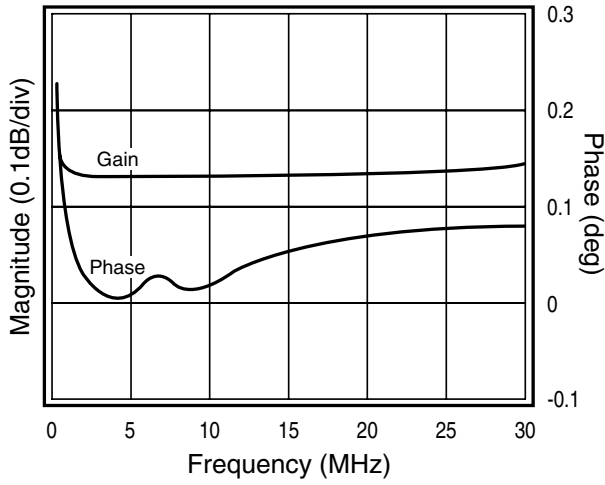

01500223

Small Signal Pulse Response

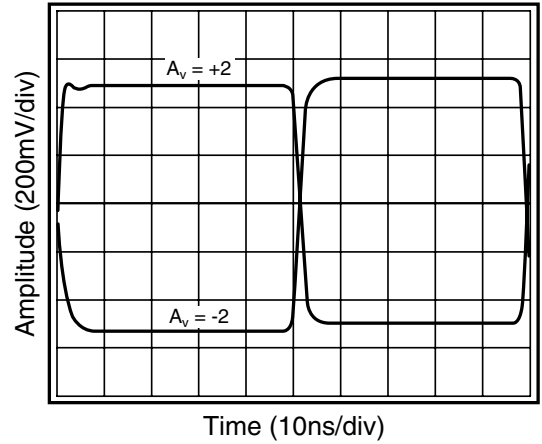

01500224

Large Signal Pulse Response

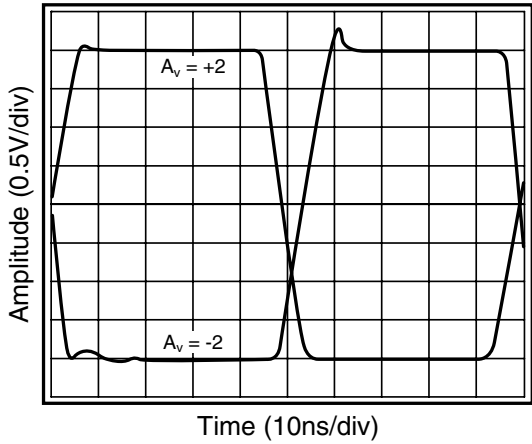

01500225

Differential Gain and Phase

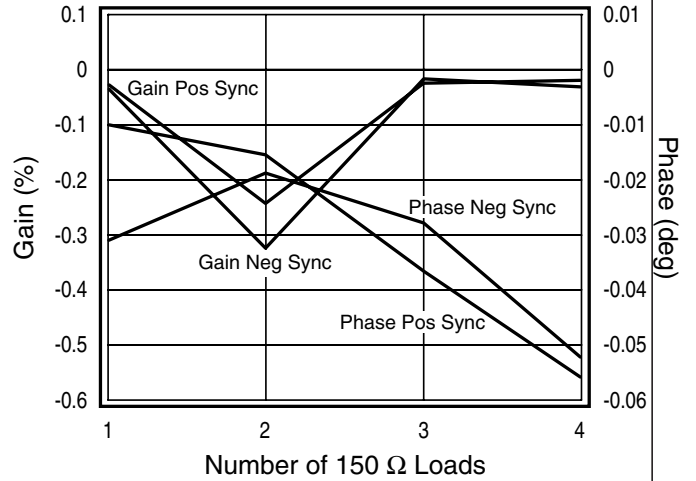

01500226

2nd & 3rd Harmonic Distortion

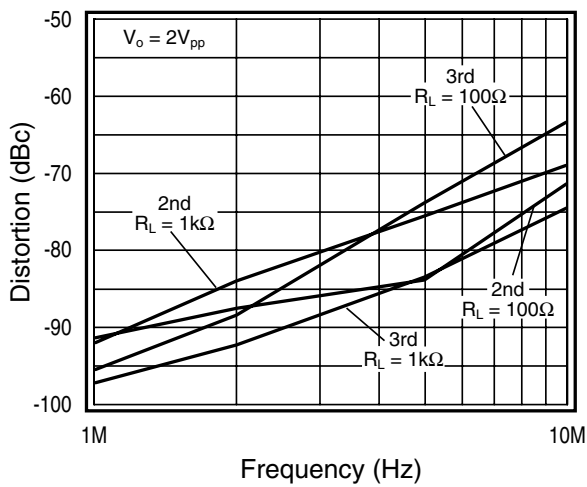

01500227

2nd & 3rd Harmonic Distortion, $R_L = 25\Omega$

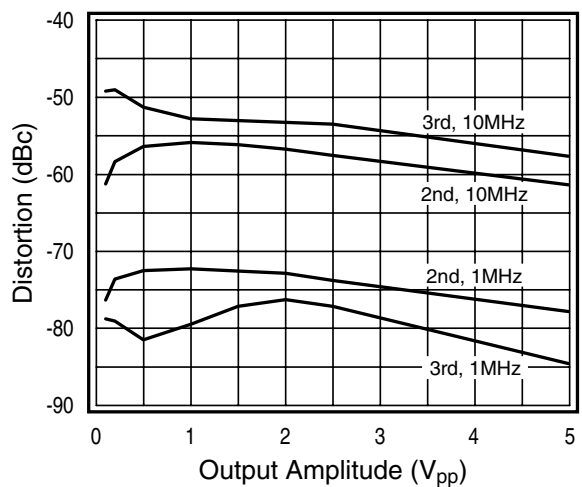

01500228

±5V Typical Performance ($A_V = +2$, $R_f = 750\Omega$, $R_L = 100\Omega$, $V_{CC} = \pm 5V$, unless specified) (Continued)

2nd & 3rd Harmonic Distortion, $R_L = 100\Omega$

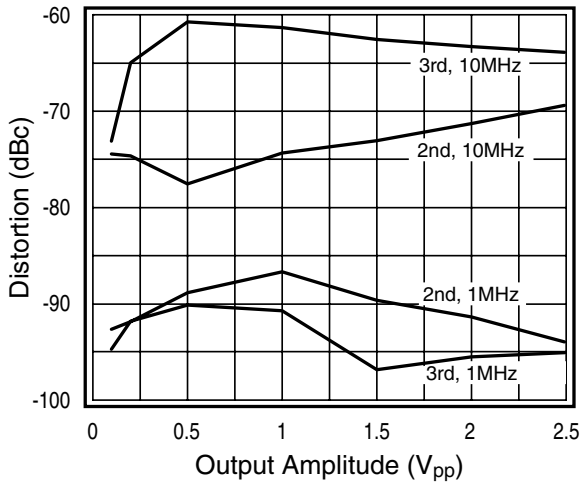

01500229

2nd & 3rd Harmonic Distortion, $R_L = 1k\Omega$

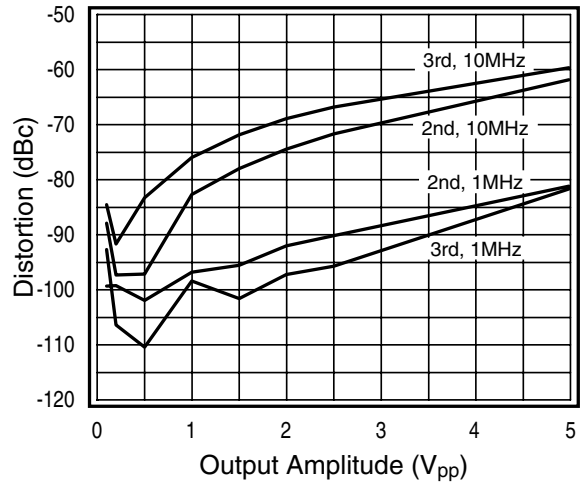

01500230

Short Term Settling Time

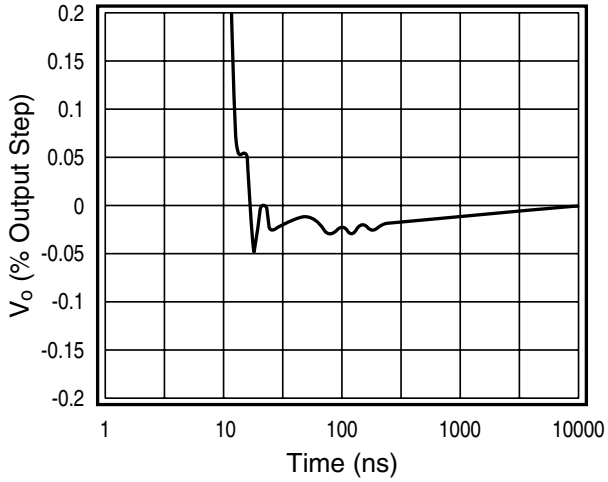

01500231

Long Term Settling Time

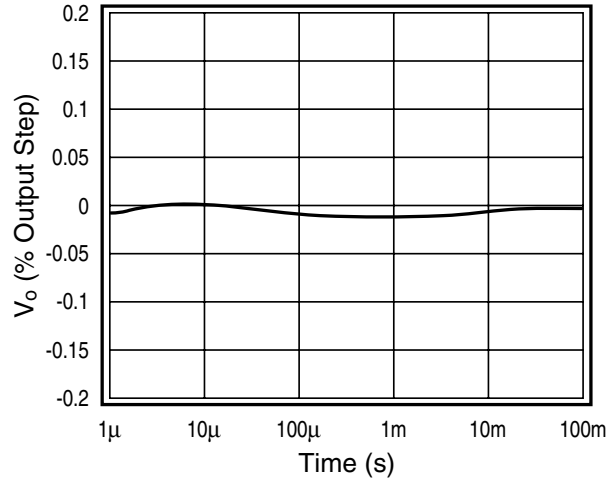

01500232

I_{BI} , I_{BN} , V_{OS} vs. Temperature

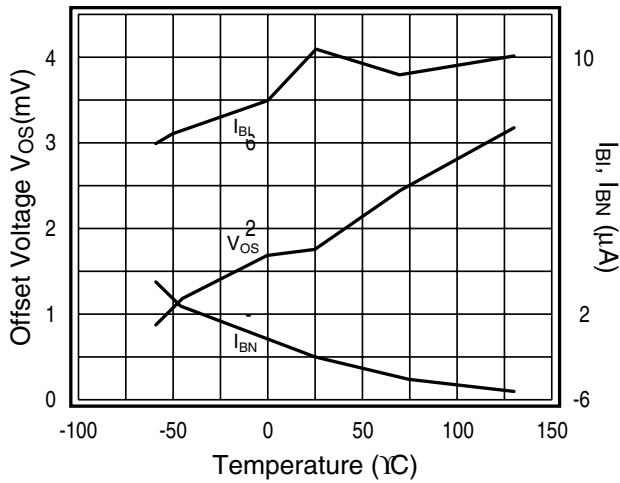

01500233

Channel Matching

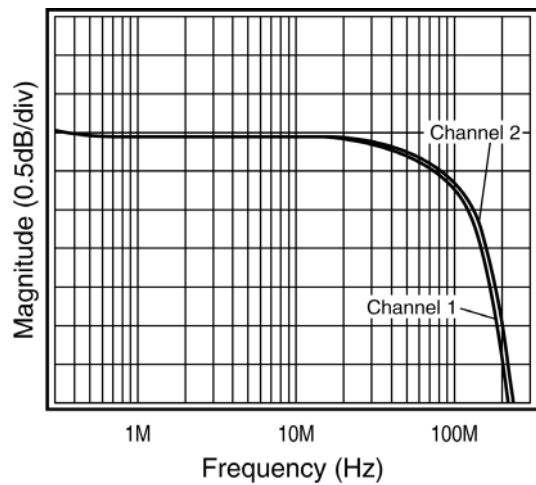

01500234

±5V Typical Performance ($A_V = +2$, $R_f = 750\Omega$, $R_L = 100\Omega$, $V_{CC} = \pm 5V$, unless specified) (Continued)

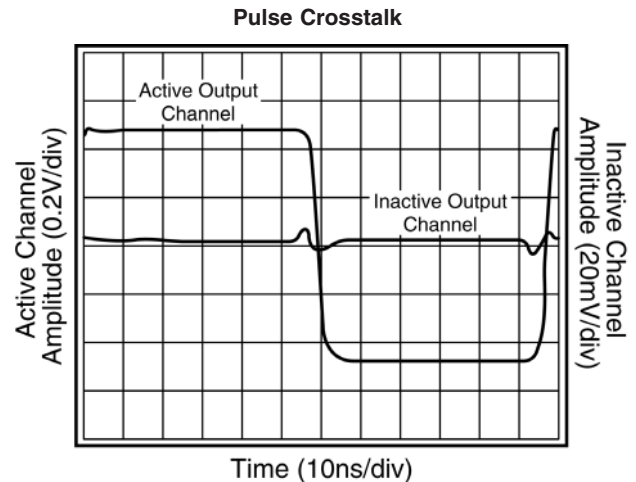
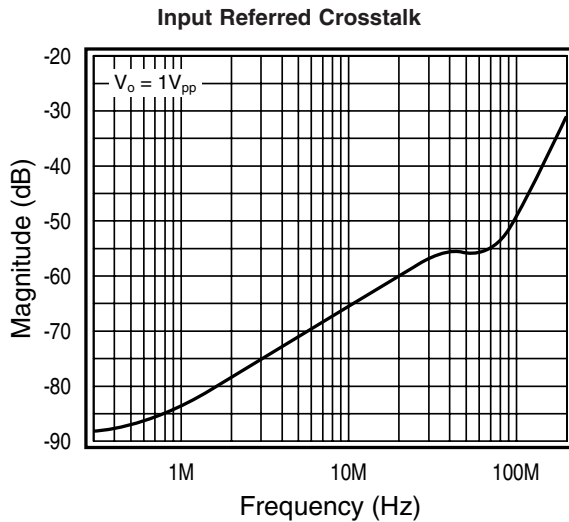

01500236

01500235

Application Division

CLC5622 Operation

The CLC5622 is a current feedback amplifier fabricated in an advanced complementary bipolar process. The CLC5622 operates from a single 5V supply or dual ±5V supplies. Operating from a single supply, the CLC5622 has the following features:

- Provides 100mA of output current while consuming 15mW of power
- Offers low -80/-83dB 2nd and 3rd harmonic distortion
- Provides $BW > 80\text{MHz}$ and 1MHz distortion $< -75\text{dBc}$ at $V_O = V_{PP}$

The CLC5622 performance is further enhanced in ±5V supply applications as indicated in the ±5V Electrical Characteristics table and ±5V Typical Performance plots.

Current Feedback Amplifiers

Some of the key features of current feedback technology are:

- Independence of AC bandwidth and voltage gain
- Inherently stable at unity gain
- Adjustable frequency response with feedback resistor
- High slew rate
- Fast Settling

Current feedback operation can be described using a simple equation. The voltage gain for a non-inverting or inverting current feedback amplifier is approximated by Equation 1.

$$\frac{V_o}{V_{in}} = \frac{A_V}{1 + \frac{R_f}{Z(j\omega)}}$$

where:

- A_V is the closed loop DC voltage gain
- R_f is the feedback resistor
- $Z(j\omega)$ is the CLC5622's open loop transimpedance gain
- $\frac{Z(j\omega)}{R_f}$ is the loop gain

The denominator of Equation 1 is approximately equal to 1 at low frequencies. Near the -3dB corner frequency, the interaction between R_f and $Z(j\omega)$ dominates the circuit performance. The value of the feedback resistor has a large effect on the circuit's performance. Increasing R_f has the following effects:

- Decreases loop gain
- Decreases bandwidth
- Reduces gain peaking
- Lowers pulse response overshoot
- Affects frequency response phase linearity

Refer to the Feedback Resistor Selection section for more details on selecting a feedback resistor value.

CLC5622 Design Information

Single Supply Operation ($V_{CC} = +5V$, $V_{EE} = \text{GND}$)

The specifications given in the +5V Electrical Characteristics table for single supply operation are measured with a common mode voltage (V_{cm}) of 2.5V. V_{cm} is the voltage around which the inputs are applied and the output voltages are specified.

Operating from a single +5V supply, the Common Mode Input Range (CMIR) of the CLC5622 is typically +0.8V to +4.2V. The typical output range with $R_L = 100\Omega$ is +1.0V to +4.0V.

For single supply DC coupled operation, keep input signal levels above 0.8V DC. For input signals that drop below 0.8V DC, AC coupling and level shifting the signal are recommended. The non-inverting and inverting configurations for both input conditions are illustrated in the following 2 sections.

DC Coupled Single Supply Operation

Figure 1 and Figure 2 show the recommended non-inverting and inverting configurations for input signals that remain above 0.8V DC. Note: R_f , R_L , and R_G are tied to V_{cm} for minimum power consumption and maximum output swing.

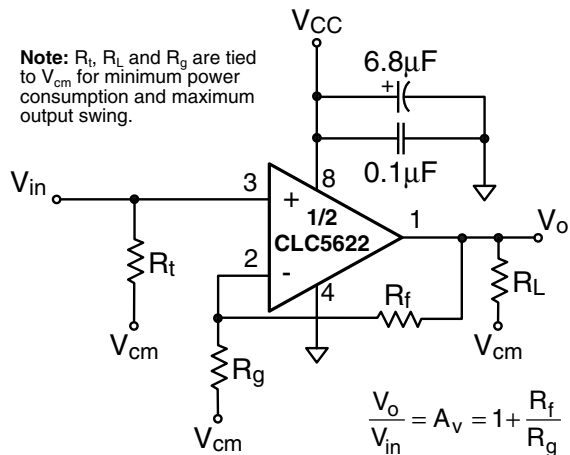

01500239

FIGURE 1. Non-Inverting Configuration

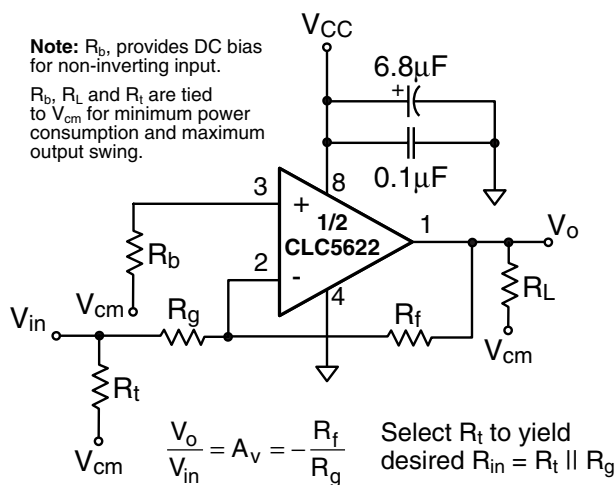

01500240

FIGURE 2. Inverting Configuration

AC Coupled Single Supply Operation

Figure 3 and Figure 4 show possible non-inverting and inverting configurations for input signals that go below 0.8V DC. The input is AC coupled to prevent the need for level shifting the input signal at the source. The resistive voltage divider biases the non-inverting input to $V_{CC} \div 2 = 2.5V$ (For $V_{CC} = +5V$).

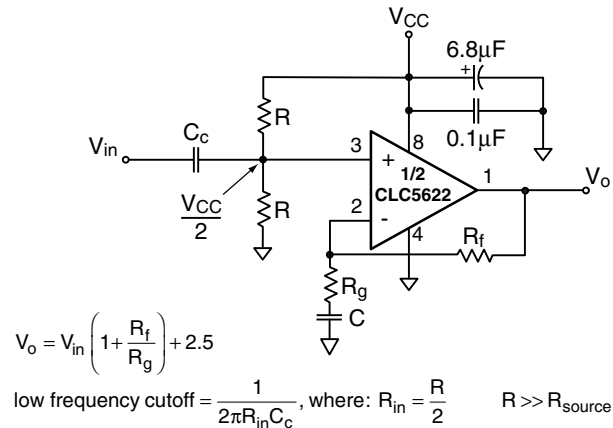

01500241

FIGURE 3. AC Coupled Non-Inverting Configuration

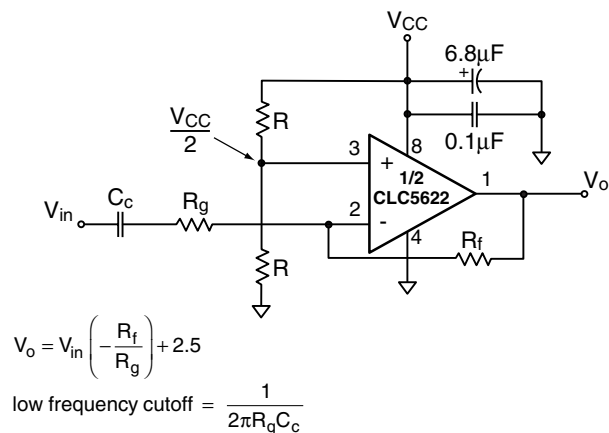

01500242

FIGURE 4. Dual Supply Non-Inverting Configuration

Dual Supply Operation

The CLC5622 operates on dual supplies as well as single supplies. The non-inverting and inverting configurations are shown in Figure 5 and Figure 6.

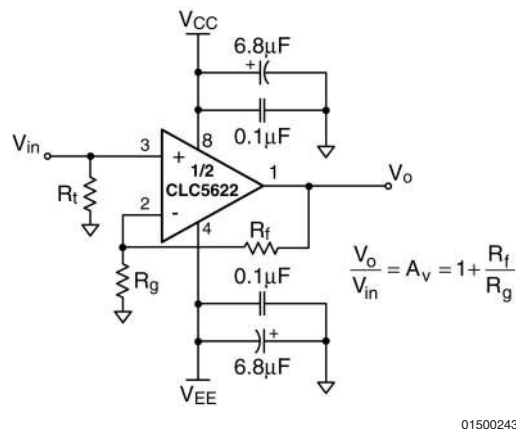

01500243

FIGURE 5. Dual Supply Non-Inverting Configuration

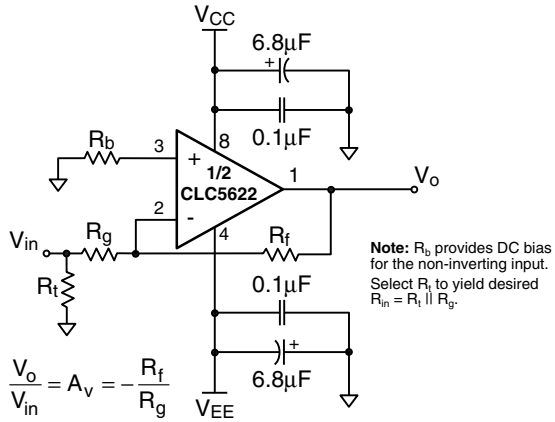

01500244

FIGURE 6. Dual Supply Inverting Configuration

Feedback Resistor Selection

The feedback resistor, R_f , affects the loop gain and frequency response of a current feedback amplifier. Optimum performance of the CLC5622, at a gain of $+2V/V$, is achieved with R_f equal to 750Ω . The frequency response plots in the Typical Performance sections illustrate the recommended R_f for several gains. These recommended values of R_f provide the maximum bandwidth with minimal peaking. Within limits, R_f can be adjusted to optimize the frequency response.

- Decrease R_f to peak frequency response and extend bandwidth
- Increase R_f to roll off frequency response and compress bandwidth

As a rule of thumb, if the recommended R_f is doubled, then the bandwidth will be cut in half.

Unity Gain Operation

The recommended R_f for unity gain ($+1V/V$) operation is $1.2k\Omega$. R_g is left open. Parasitic capacitance at the inverting node may require a slight increase in R_f to maintain a flat frequency response.

Load Termination

The CLC5622 can source and sink near equal amounts of current. For optimum performance, the load should be tied to V_{CM} .

Driving Cables and Capacitive Loads

When driving cables, double termination is used to prevent reflections. For capacitive load applications, a small series resistor at the output of the CLC5622 will improve stability and settling performance. The **Frequency Response vs. C_L** plot, shown below in Figure 7, gives the recommended series resistance value for optimum flatness at various capacitive loads.

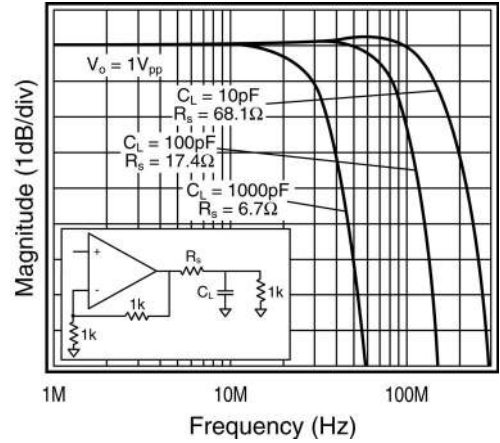

01500245

FIGURE 7. Frequency Response vs. C_L

Transmission Line Matching

One method for matching the characteristic impedance (Z_0) of a transmission line or cable is to place the appropriate resistor at the input or output of the amplifier. Figure 8 shows typical inverting and non-inverting circuit configurations for matching transmission lines.

Non-inverting gain applications:

- Connect R_3 directly to ground.
- Make $R_1, R_2, R_6,$ and R_7 equal to Z_0 .
- Use R_3 to isolate the amplifier from reactive loading caused by the transmission line, or by parasitics.

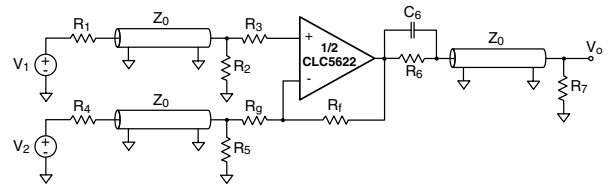

01500246

FIGURE 8. Transmission Line Matching

Inverting gain applications:

- Connect R_3 directly to ground.
- Make the resistors $R_4, R_6,$ and R_7 equal to Z_0 .
- Make $R_5 \parallel R_g = Z_0$

The input and output matching resistors attenuate the signal by a factor of 2, therefore additional gain is needed. Use C_6 to match the output transmission line over a greater frequency range. C_6 compensates for the increase of the amplifier's output impedance with frequency.

Power Dissipation

Follow these steps to determine the power consumption of the CLC5622.

1. Calculate the quiescent (no-load) power: $P_{amp} = I_{CC} (V_{CC} - V_{EE})$
2. Calculate the RMS power at the output stage: $P_o = (V_{CC} - V_{load}) (I_{load})$, where V_{load} and I_{load} are the RMS voltage and current across the external load.
3. Calculate the total RMS power: $P_t = P_{amp} + P_o$

The maximum power that the DIP and SOIC packages can dissipate at a given temperature is illustrated in *Figure 9*. The power derating curve for any CLC5622 package can be derived by utilizing the following equation:

$$\frac{(150^\circ - T_{amb})}{\theta_{JA}}$$

where

T_{amb} =Ambient temperature ($^\circ\text{C}$)

θ_{JA} =Thermal resistance, from junction to ambient, for a given package ($^\circ\text{C/W}$)

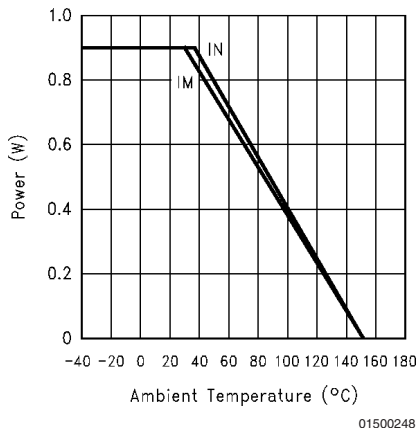

FIGURE 9. Power Derating Curves

Layout Considerations

A proper printed circuit layout is essential for achieving high frequency performance. National provides evaluation boards for the CLC5622 (CLC730038-DIP, CLC730036-SOIC) and suggests their use as a guide for high frequency layout and as an aid for device testing and characterization.

General layout and supply bypassing play major roles in high frequency performance. Follow these steps below as a basis for high frequency layout:

- Include 6.8 μF tantalum and 0.1 μF ceramic capacitors on both supplies.
- Place the 6.8 μF capacitors within 0.75 inches of the power pins.
- Place the 0.1 μF capacitors less than 0.1 inches from the power pins.
- Remove the ground plane under and around the part, especially near the input and output pins to reduce parasitic capacitance.
- Minimize all trace lengths to reduce series inductances.
- Use flush-mount printed circuit board pins for prototyping, never use high profile DIP sockets.

Evaluation Board Information

A data sheet is available for the CLC730038/CLC730036 evaluation boards. The evaluation board data sheet provides:

- Evaluation board schematics
- Evaluation board layouts
- General information about the boards

The evaluation boards are designed to accommodate dual supplies. The boards can be modified to provide single supply operation. For best performance; 1) do not connect the unused supply, 2) ground the unused supply pin.

SPICE Models

SPICE models provide a means to evaluate amplifier designs. Free SPICE models are available for National's monolithic amplifiers that:

- Support Berkeley SPICE 2G and its many derivatives
- Reproduces typical DC, AC, Transient, and Noise performance
- Support room temperature simulations

The *readme* file that accompanies the diskette lists released models, and provides a list of modeled parameters. The application note OA-18, Simulation SPICE Models for National's Op Amps, contains schematics and a reproduction of the *readme* file.

Application Circuits

Single Supply Cable Driver

The typical application shown below shows one of the CLC5622 amplifiers driving 10m of 75 Ω coaxial cable. The CLC5622 is set for a gain of +2V/V to compensate for the divide-by-two voltage drop at V_O .

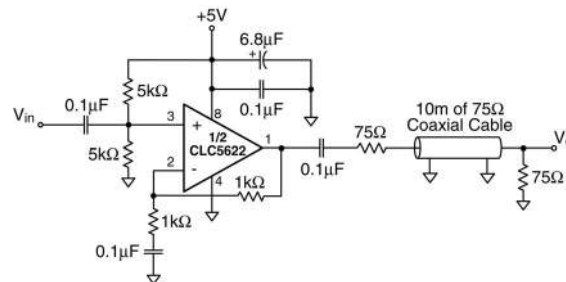

01500249

FIGURE 10. Single Supply Cable Driver

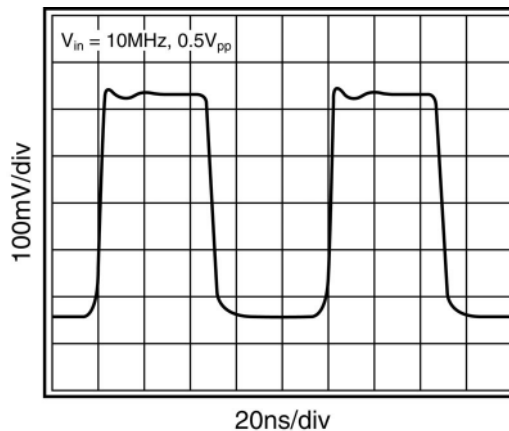

01500250

FIGURE 11. Response After 10m of Cable

Single Supply Lowpass Filter

Figure 12 and *Figure 13* illustrate a lowpass filter and design equations. The circuit operates from a single supply of +5V. The voltage divider biases the non-inverting input to 2.5V. And the input is AC coupled to prevent the need for level

shifting the input signal at the source. Use the design equations to determine R_1 , R_2 , C_1 , and C_2 based on the desired Q and corner frequency.

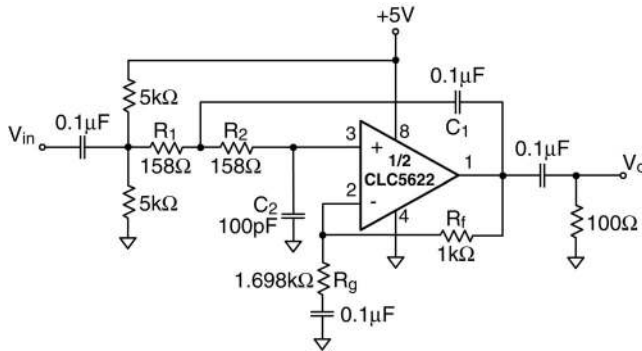

01500251

FIGURE 12. Lowpass Filter Topology

$$\text{Gain} = K = 1 + \frac{R_f}{R_g}$$

$$\text{Corner frequency} = \omega_c = \sqrt{\frac{1}{R_1 R_2 C_1 C_2}}$$

$$Q = \frac{1}{\sqrt{\frac{R_2 C_2}{R_1 C_1} + \frac{R_1 C_2}{R_2 C_1} + (1-K) \sqrt{\frac{R_1 C_1}{R_2 C_2}}}}$$

For $R_1 = R_2 = R$ and $C_1 = C_2 = C$

$$\omega_c = \frac{1}{RC}$$

$$Q = \frac{1}{(3-K)}$$

01500252

FIGURE 13. Design Equations

This example illustrates a lowpass filter with $Q=0.707$ and corner frequency $f_c/10\text{MHz}$. A Q of the 0.707 was chosen to achieve a maximally flat, Butterworth response. Figure 14 indicates the filter response.

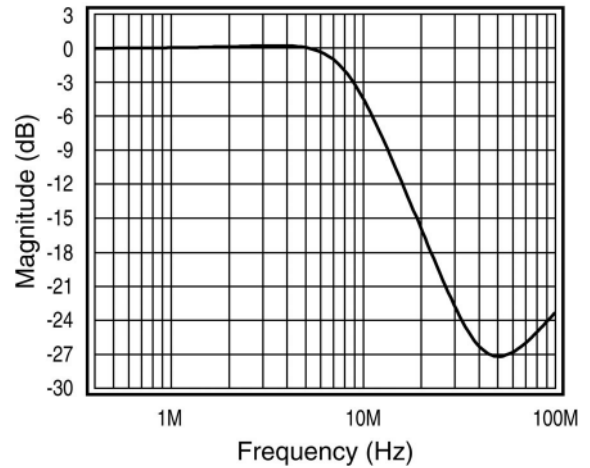

01500253

FIGURE 14. Lowpass Response

Differential Line Driver With Load Impedance Conversion

The circuit shown in the **Typical Application** schematic on the front page and in Figure 15, operates as a differential line driver. The transformer converts the load impedance to a value that best matches the CLC5622's output capabilities. The single-ended input signal is converted to a differential signal by the CLC5622. The line's characteristic impedance is matched at both the input and the output. The schematic shows Unshielded Twisted Pair for the transmission line; other types of lines can also be driven.

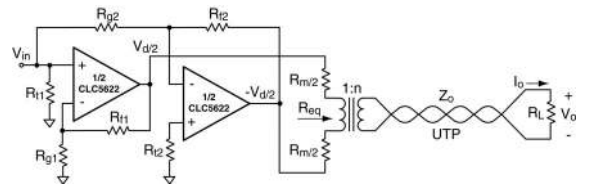

01500254

FIGURE 15. Differential Line Driver with Load Impedance Conversion

Set up the CLC5622 as a difference amplifier:

$$\frac{V_d}{V_{in}} = 2 \cdot \left(1 + \frac{R_{f1}}{R_{g1}} \right) = 2 \cdot \frac{R_{f2}}{R_{g2}}$$

Make the best use of the CLC5622's output drive capability as follows:

$$R_m + R_{eq} = \frac{2 \cdot V_{max}}{I_{max}}$$

where R_{eq} is the transformed value of the load impedance, V_{max} is the Output Voltage Range, and I_{max} is the maximum Output Current.

Match the line's characteristic impedance:

$$R_L = Z_o$$

$$R_m = R_{eq}$$

$$n = \sqrt{\frac{R_L}{R_{eq}}}$$

Select the transformer so that it loads the line with a value very near Z_o over frequency range. The output impedance of the CLC5622 also affects the match. With an ideal transformer we obtain:

$$\text{Return Loss} = -20 \cdot \log_{10} \left| \frac{n^2 \cdot Z_{O(5622)}(j\omega)}{Z_o} \right|, \text{dB}$$

where $Z_{O(5622)}(j\omega)$ is the output impedance of the CLC5622 and $|Z_{O(5622)}(j\omega)| \ll R_m$.

The load voltage and current will fall in the ranges:

$$|V_o| \leq n \cdot V_{\max}$$

$$|I_o| \leq \frac{I_{\max}}{n}$$

The CLC5622's high output drive current and low distortion make it a good choice for the application.

Full Duplex Cable Driver

The circuit shown in *Figure 16* below, operates as a full duplex cable driver which allows simultaneous transmission and reception of signals on one transmission line. The circuit on either side of the transmission line uses are CLC5622 as a cable drive, and the second CLC5622 as a receiver. V_{oA} is an attenuated version of V_{inA} , while V_{oB} is an attenuated version of V_{inB} .

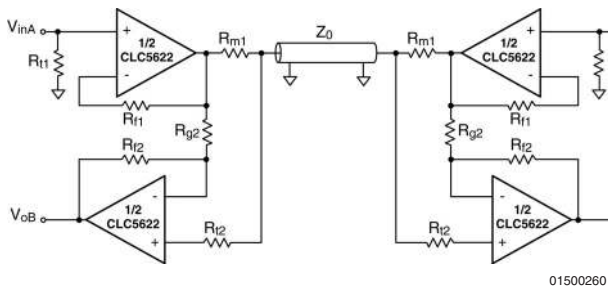

FIGURE 16. Full Duplex Cable Driver

R_{m1} is used to match the transmission line. R_{f2} and R_{g2} set the DC gain of the CLC5622, which is used in a difference mode. R_{f2} provides good CMRR and DC offset. The transmitting CLC5622's are shown in a unity gain configuration because they consume the least power of any gain, for a given load. for proper operation we need $R_{f2} = R_{g2}$.

$$V_{outA(B)} \approx V_{inA(B)} \cdot A + \frac{V_{inB(A)}}{2} \cdot \left(1 - \frac{R_{f2}}{R_{g2}} + \frac{Z_{O(5622)}(j\omega)}{R_{m1}} \right)$$

where A is the attenuation of the cable $Z_{O(5622)}(j\omega)$ is the output impedance of the CLC5622 (see the *Closed-Loop Output Resistance* plot), and $|Z_{O(5622)}(j\omega)| \ll R_{m1}$.

We selected the component values as follows:

- $R_{f1} = 1.2k\Omega$, the recommended value for CLC5622 at unity gain.
- $R_{m1} = Z_o = 50\Omega$, the characteristic impedance of the transmission line.
- $R_{f2} = R_{g2} = 750\Omega \geq R_{m1}$, the recommended value for the CLC5622 at $A_v = 2$
- $R_{f2} = (R_{f2} || R_{g2}) - R_{m1} / 2 = 25\Omega$

These values give excellent isolation from the other input:

$$\frac{V_{oA(B)}}{V_{inB(A)}} \approx -38\text{dB}, f = 5.0\text{MHz}$$

01500263

The CLC5622 provides large output current drive, while consuming little supply current, at the nominal bias point. It also produces low distortion with large signal swings and heavy loads. These features make the CLC5622 an excellent choice for driving transmission lines.

Physical Dimensions inches (millimeters)
unless otherwise noted

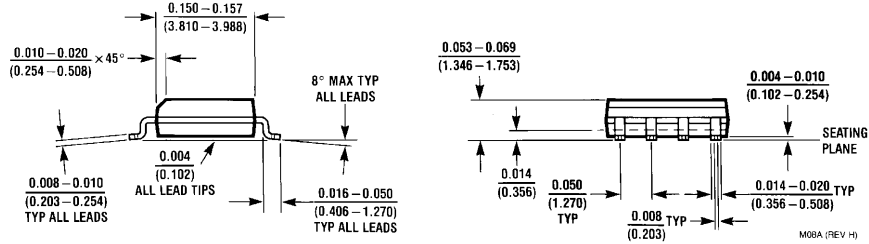
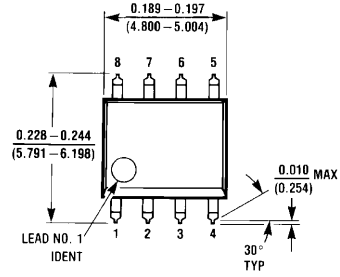

8-Pin SOIC
NS Package Number M08A

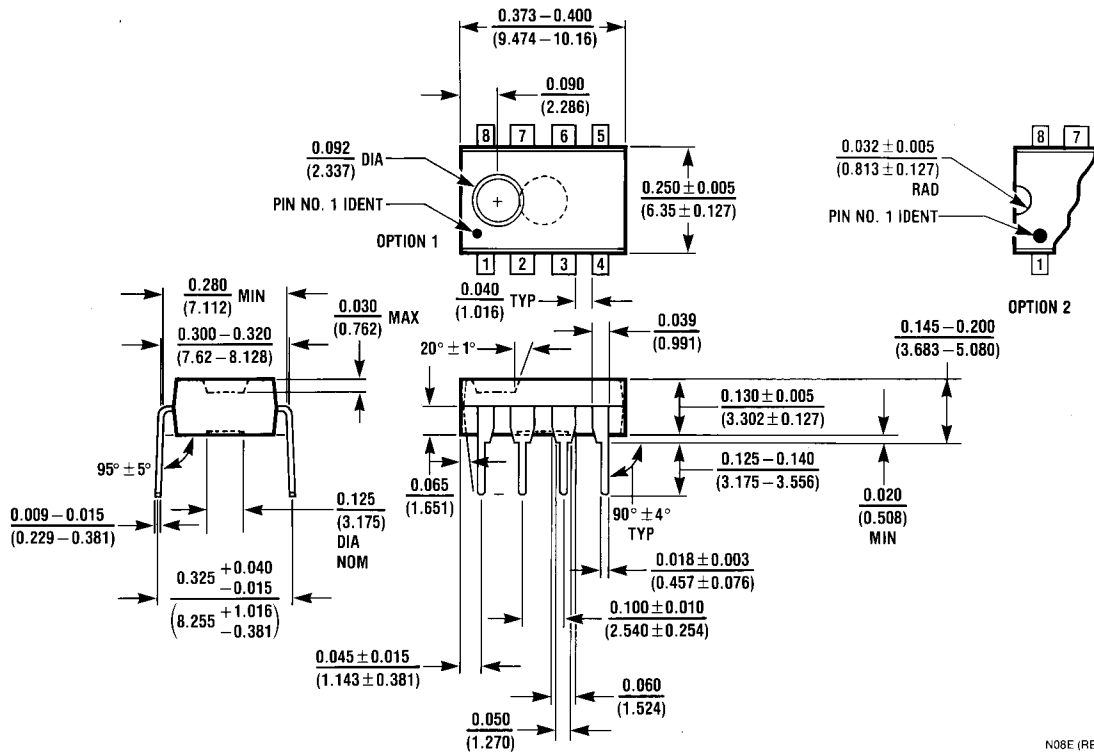

8-Pin MDIP
NS Package Number N08E

Notes

National does not assume any responsibility for use of any circuitry described, no circuit patent licenses are implied and National reserves the right at any time without notice to change said circuitry and specifications.

For the most current product information visit us at www.national.com.

LIFE SUPPORT POLICY

NATIONAL'S PRODUCTS ARE NOT AUTHORIZED FOR USE AS CRITICAL COMPONENTS IN LIFE SUPPORT DEVICES OR SYSTEMS WITHOUT THE EXPRESS WRITTEN APPROVAL OF THE PRESIDENT AND GENERAL COUNSEL OF NATIONAL SEMICONDUCTOR CORPORATION. As used herein:

1. Life support devices or systems are devices or systems which, (a) are intended for surgical implant into the body, or (b) support or sustain life, and whose failure to perform when properly used in accordance with instructions for use provided in the labeling, can be reasonably expected to result in a significant injury to the user.
2. A critical component is any component of a life support device or system whose failure to perform can be reasonably expected to cause the failure of the life support device or system, or to affect its safety or effectiveness.

BANNED SUBSTANCE COMPLIANCE

National Semiconductor manufactures products and uses packing materials that meet the provisions of the Customer Products Stewardship Specification (CSP-9-111C2) and the Banned Substances and Materials of Interest Specification (CSP-9-111S2) and contain no "Banned Substances" as defined in CSP-9-111S2.



National Semiconductor
Americas Customer
Support Center
Email: new.feedback@nsc.com
Tel: 1-800-272-9959

National Semiconductor
Europe Customer Support Center
Fax: +49 (0) 180-530 85 86
Email: europe.support@nsc.com
Deutsch Tel: +49 (0) 69 9508 6208
English Tel: +44 (0) 870 24 0 2171
Français Tel: +33 (0) 1 41 91 8790

National Semiconductor
Asia Pacific Customer
Support Center
Email: ap.support@nsc.com

National Semiconductor
Japan Customer Support Center
Fax: 81-3-5639-7507
Email: jpn.feedback@nsc.com
Tel: 81-3-5639-7560