

VERONICA-SQ-W

~50° wide beam

SPECIFICATION:

Dimensions	22.5 x 22.5 mm
Height	11.8 mm
Fastening	tape
ROHS compliant	yes ⓘ

MATERIALS:

Component	Type	Material	Colour	Finish
VERONICA-SQ-W	Single lens	PMMA	clear	
VERONICA-TAPE	Tape	Acrylic foam	clear	

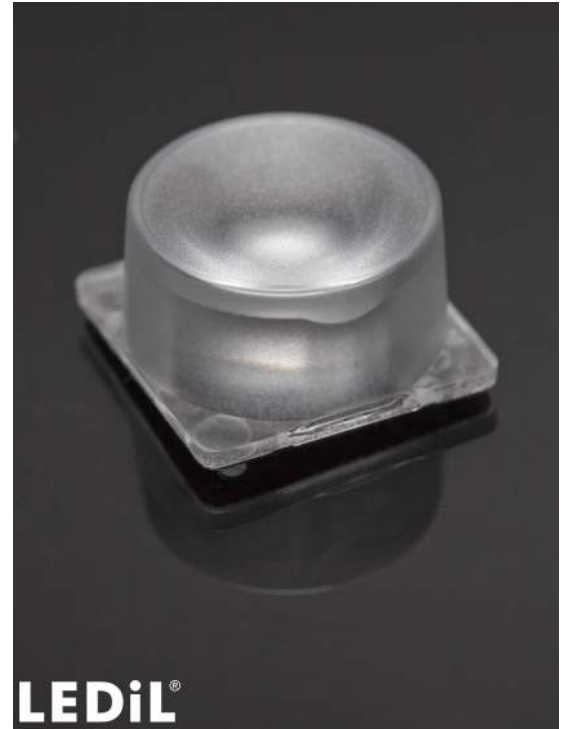

ORDERING INFORMATION:

Component	Type	Qty in box	MOQ	MPQ	Box weight (kg)
CA14442_VERONICA-SQ-W » Box size: 476 x 273 x 197 mm	Single lens	1980	360	180	8.8

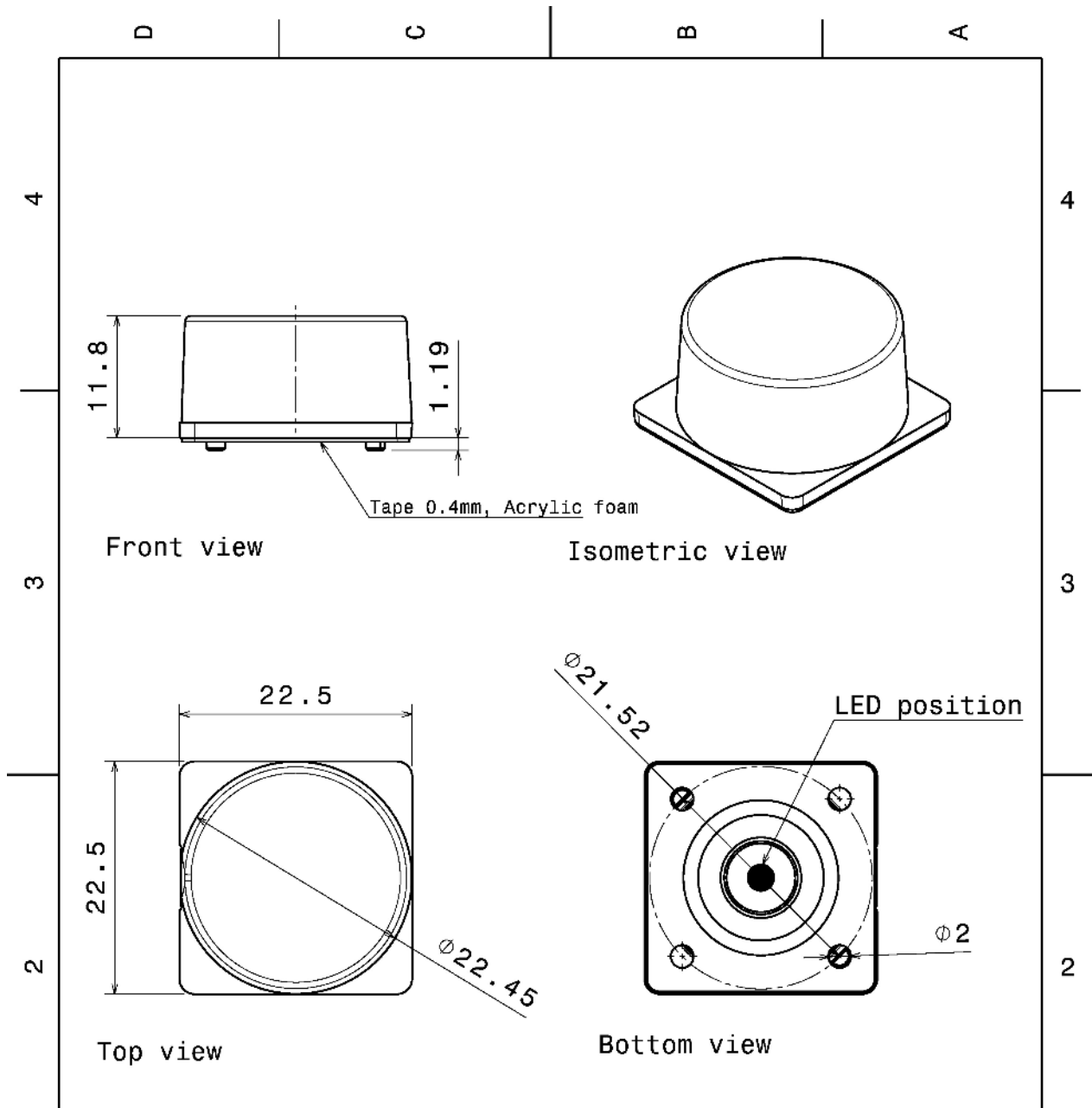

INDEX	PART NO	DESCRIPTION	MATERIAL	COLOUR
1	C14447	VERONICA-SQ-W	PMMA	clear

Tolerances if not otherwise shown
 According to DIN ISO 2768-1
 Linear measures:
 Up to 30mm class M, otherwise class C
 According to DIN ISO 2768-2
 Form and position: class L

LEDiL Ledil Oy
 Salorankatu 10
 FIN 24240 SALO
 Finland

THIRD ANGLE PROJECTION:

DRAWING TITLE
CA14442_VERONICA-SQ-W





This drawing is the property of LEDiL Oy. It may not be reproduced, copied or communicated without a written agreement with LEDiL Oy.

SIZE	PART NUMBER
A4	CA14442

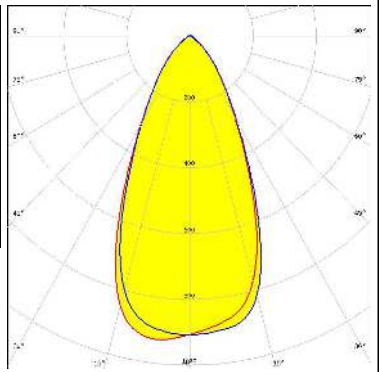

SCALE	2:1	WEIGHT	3,90 g	SHEET	1/1
-------	-----	--------	--------	-------	-----

See also our general installation guide: www.ledil.com/installation_guide

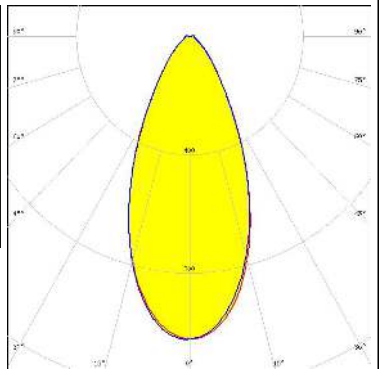
OPTICAL RESULTS (MEASURED):

<p>CREE ⇄ LED</p> <p>LED XB-H FWHM / FWTM 50.0° / 90.0° Efficiency 80 % Peak intensity 0.9 cd/lm LEDs/each optic 1 Light colour White Required components:</p>		
<p>CREE ⇄ LED</p> <p>LED XHP35 HD FWHM / FWTM 52.0° / 92.0° Efficiency 78 % Peak intensity 1 cd/lm LEDs/each optic 1 Light colour White Required components:</p>		
<p>CREE ⇄ LED</p> <p>LED XHP35 HI FWHM / FWTM 49.0° / 86.0° Efficiency 81 % Peak intensity 1.1 cd/lm LEDs/each optic 1 Light colour White Required components:</p>		
<p>CREE ⇄ LED</p> <p>LED XHP50.2 FWHM / FWTM 47.0° / 89.0° Efficiency 86 % Peak intensity 1 cd/lm LEDs/each optic 1 Light colour White Required components:</p>		

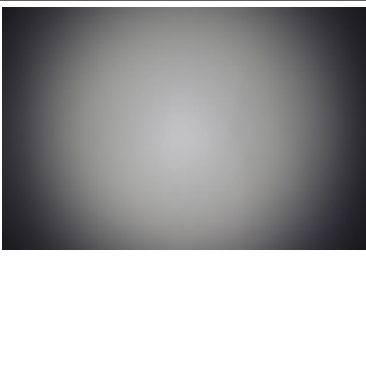
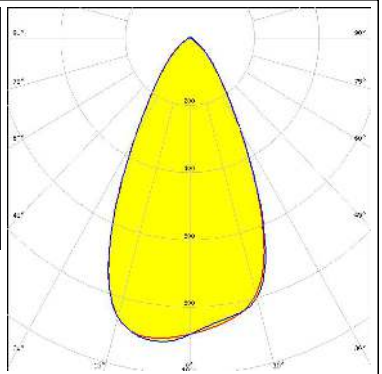
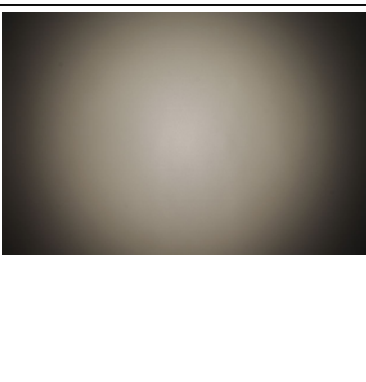
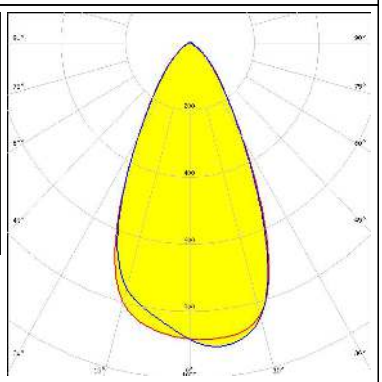
OPTICAL RESULTS (MEASURED):

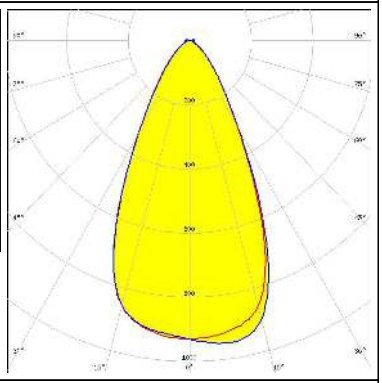
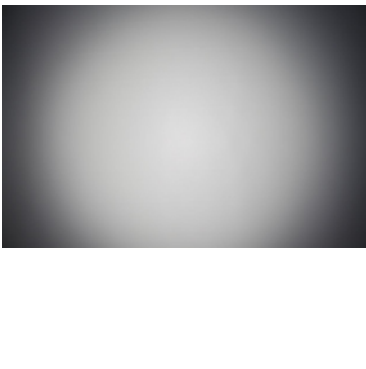
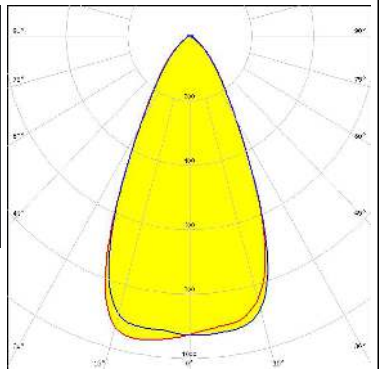
<p>CREE ⇄ LED</p> <p>LED XM-L FWHM / FWTM 53.0° / 90.0° Efficiency 81 % Peak intensity 0.9 cd/lm LEDs/each optic 1 Light colour White Required components:</p>		
<p>CREE ⇄ LED</p> <p>LED XM-L2 FWHM / FWTM 53.0° / 91.0° Efficiency 80 % Peak intensity 0.9 cd/lm LEDs/each optic 1 Light colour White Required components:</p>		
<p>CREE ⇄ LED</p> <p>LED XM-L3 FWHM / FWTM 52.0° / 90.0° Efficiency 87 % Peak intensity 1 cd/lm LEDs/each optic 1 Light colour White Required components:</p>		
<p>CREE ⇄ LED</p> <p>LED XP-E FWHM / FWTM 51.0° / 88.0° Efficiency 81 % Peak intensity 1 cd/lm LEDs/each optic 1 Light colour White Required components:</p>		

OPTICAL RESULTS (MEASURED):

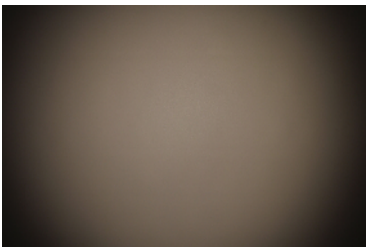
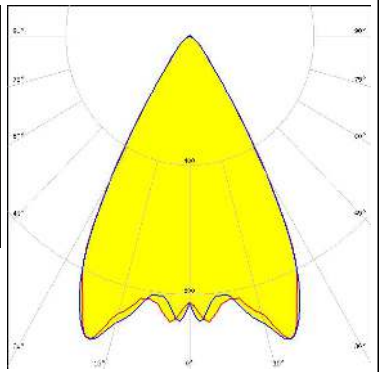
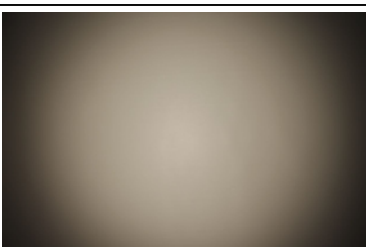
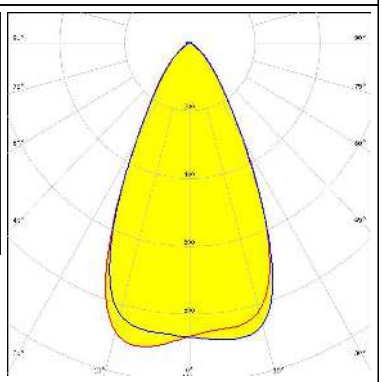
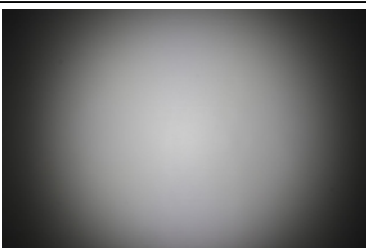
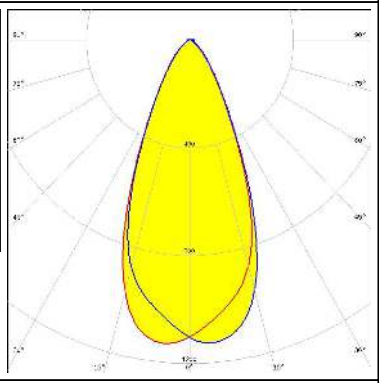
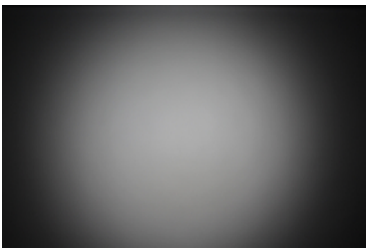
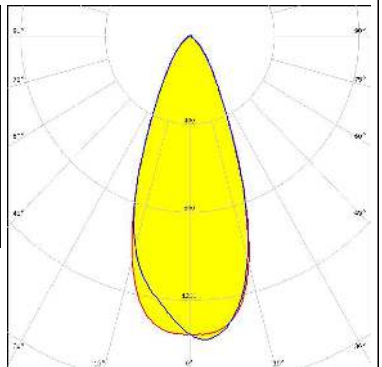
<p>CREE → LED</p> <p>LED XP-E2 FWHM / FWTM 52.0° / 94.0° Efficiency 92 % Peak intensity 1.2 cd/lm LEDs/each optic 1 Light colour White Required components:</p>		
<p>CREE → LED</p> <p>LED XP-G FWHM / FWTM 53.0° / 90.0° Efficiency 81 % Peak intensity 0.9 cd/lm LEDs/each optic 1 Light colour White Required components:</p>		
<p>CREE → LED</p> <p>LED XT-E FWHM / FWTM 46.0° / 81.0° Efficiency 80 % Peak intensity 1.1 cd/lm LEDs/each optic 1 Light colour White Required components:</p>		
<p>LUMILEDS</p> <p>LED LUXEON 3030 2D (Round LES) FWHM / FWTM 42.0° / 76.0° Efficiency 83 % Peak intensity 1.4 cd/lm LEDs/each optic 1 Light colour White Required components:</p>		

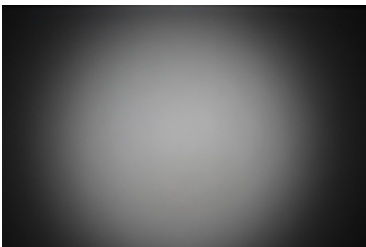
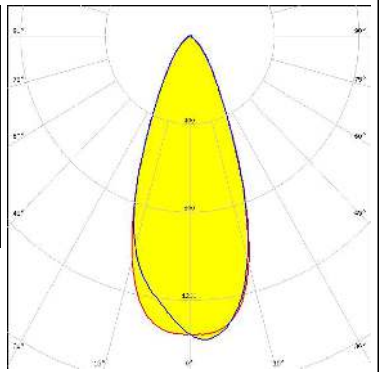
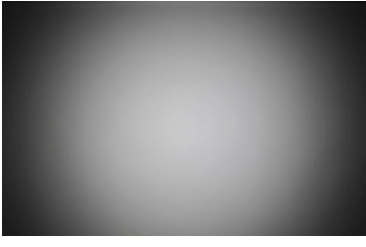
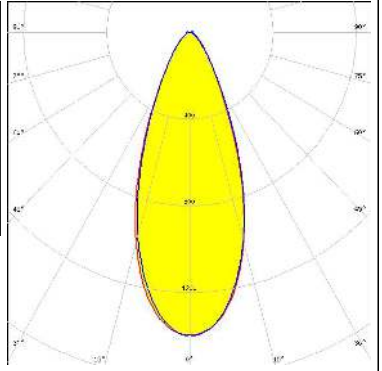
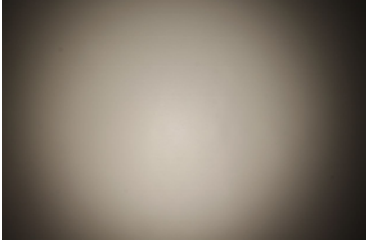
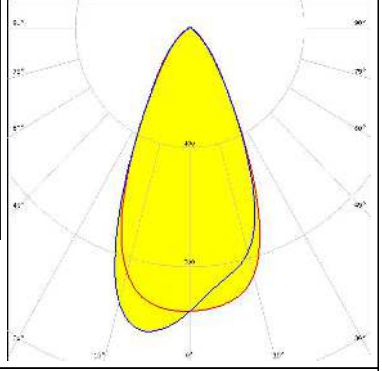
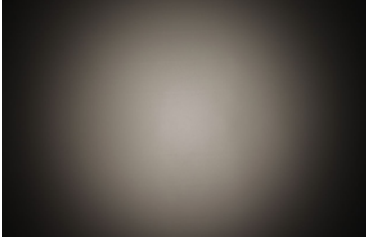
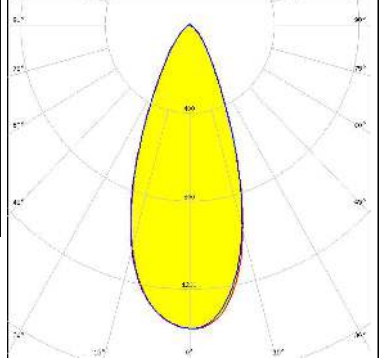

OPTICAL RESULTS (MEASURED):

<p>LUMILEDS</p> <p>LED LUXEON 3030 2D (Square LES)</p> <p>FWHM / FWTM 42.0° / 76.0°</p> <p>Efficiency 83 %</p> <p>Peak intensity 1.4 cd/lm</p> <p>LEDs/each optic 1</p> <p>Light colour White</p> <p>Required components:</p>		
<p>LUMILEDS</p> <p>LED LUXEON 5050 Round LES</p> <p>FWHM / FWTM 41.0° / 77.0°</p> <p>Efficiency 90 %</p> <p>Peak intensity 1.4 cd/lm</p> <p>LEDs/each optic 1</p> <p>Light colour White</p> <p>Required components:</p>		
<p>LUMILEDS</p> <p>LED LUXEON A</p> <p>FWHM / FWTM 50.0° / 86.0°</p> <p>Efficiency 79 %</p> <p>Peak intensity 1 cd/lm</p> <p>LEDs/each optic 1</p> <p>Light colour White</p> <p>Required components:</p>		
<p>LUMILEDS</p> <p>LED LUXEON MZ</p> <p>FWHM / FWTM 41.0° / 75.0°</p> <p>Efficiency 83 %</p> <p>Peak intensity 1.4 cd/lm</p> <p>LEDs/each optic 1</p> <p>Light colour White</p> <p>Required components:</p>		

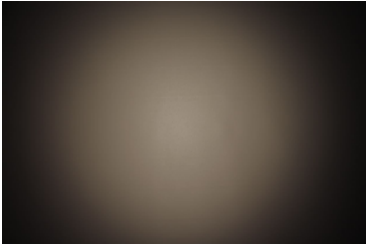
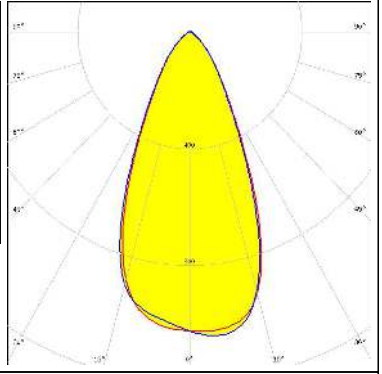
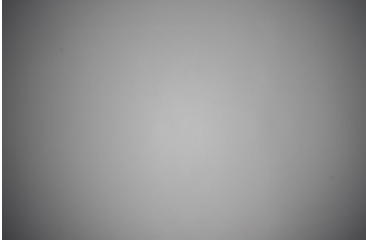
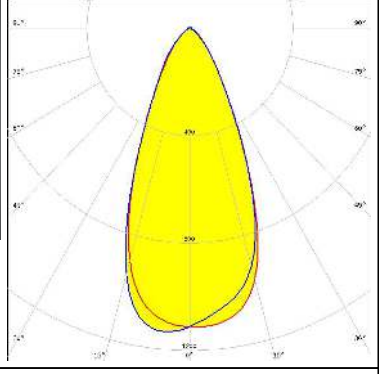
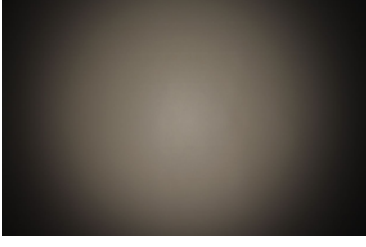
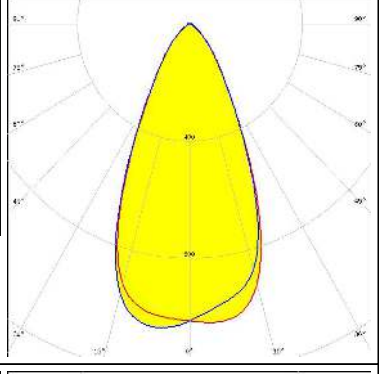
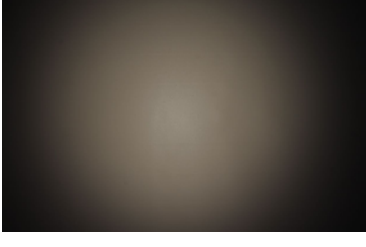
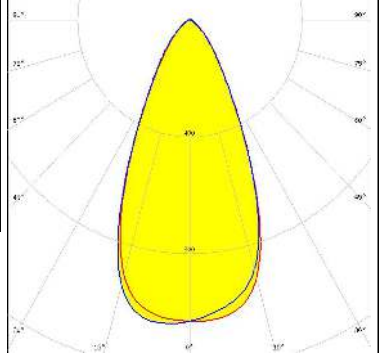
OPTICAL RESULTS (MEASURED):

<p>LUMILEDS</p> <p>LED LUXEON R</p> <p>FWHM / FWTM 48.0° / 85.0°</p> <p>Efficiency 80 %</p> <p>Peak intensity 1.1 cd/lm</p> <p>LEDs/each optic 1</p> <p>Light colour White</p> <p>Required components:</p>		
<p>LUMILEDS</p> <p>LED LUXEON Rebel ES</p> <p>FWHM / FWTM 46.0° / 82.0°</p> <p>Efficiency 80 %</p> <p>Peak intensity 1.1 cd/lm</p> <p>LEDs/each optic 1</p> <p>Light colour White</p> <p>Required components:</p>		
<p>LUMILEDS</p> <p>LED LUXEON T</p> <p>FWHM / FWTM 49.0° / 86.0°</p> <p>Efficiency 82 %</p> <p>Peak intensity 1 cd/lm</p> <p>LEDs/each optic 1</p> <p>Light colour White</p> <p>Required components:</p>		
<p>LUMILEDS</p> <p>LED LUXEON TX</p> <p>FWHM / FWTM 48.0° / 85.0°</p> <p>Efficiency 81 %</p> <p>Peak intensity 1 cd/lm</p> <p>LEDs/each optic 1</p> <p>Light colour White</p> <p>Required components:</p>		

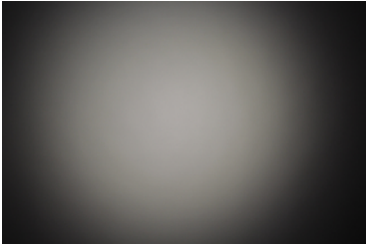
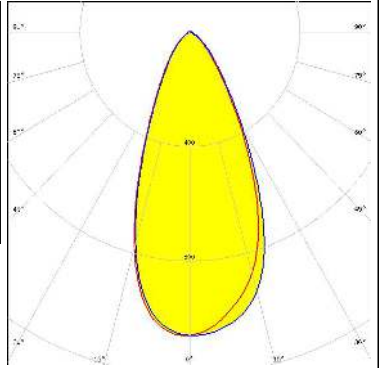
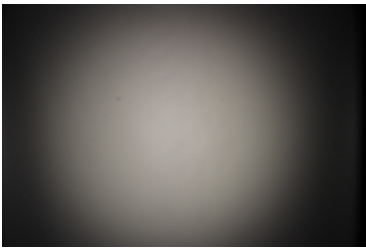
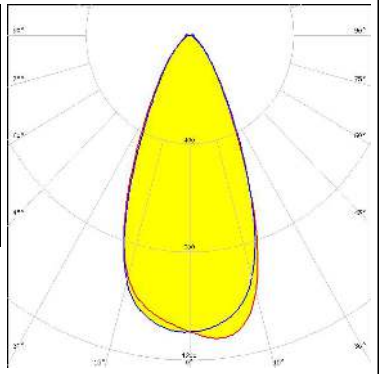
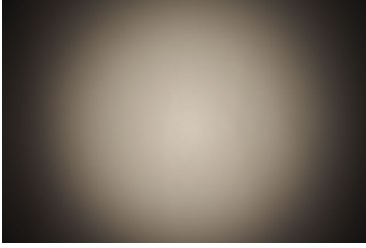
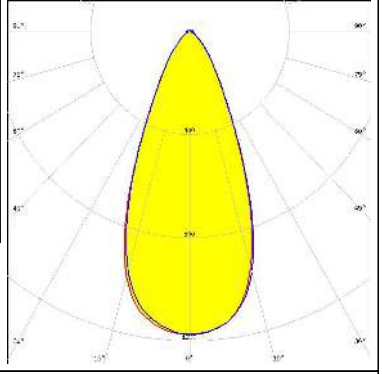

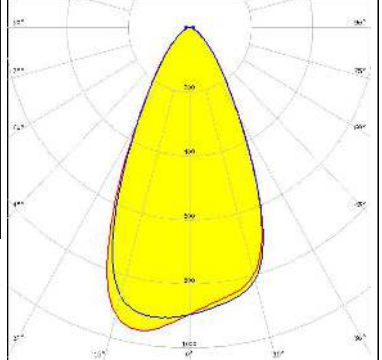
OPTICAL RESULTS (MEASURED):

<p>LUMILEDS</p> <p>LED LUXEON V</p> <p>FWHM / FWTM 46.0° / 84.0°</p> <p>Efficiency 79 %</p> <p>Peak intensity 1.1 cd/m</p> <p>LEDs/each optic 1</p> <p>Light colour White</p> <p>Required components:</p>		
<p>LUMILEDS</p> <p>LED LUXEON V2</p> <p>FWHM / FWTM 47.0° / 85.0°</p> <p>Efficiency 88 %</p> <p>Peak intensity 1.1 cd/m</p> <p>LEDs/each optic 1</p> <p>Light colour White</p> <p>Required components:</p>		
<p>NICHIA</p> <p>LED NCSxx19B</p> <p>FWHM / FWTM 45.0° / 80.0°</p> <p>Efficiency 80 %</p> <p>Peak intensity 1.2 cd/m</p> <p>LEDs/each optic 1</p> <p>Light colour White</p> <p>Required components:</p>		
<p>NICHIA</p> <p>LED NVSW219F</p> <p>FWHM / FWTM 52.0° / 92.0°</p> <p>Efficiency 88 %</p> <p>Peak intensity 1 cd/m</p> <p>LEDs/each optic 1</p> <p>Light colour White</p> <p>Required components:</p>		

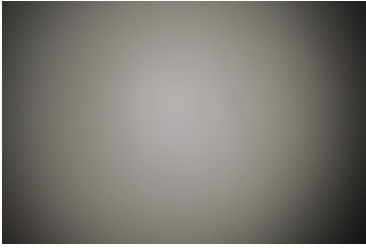
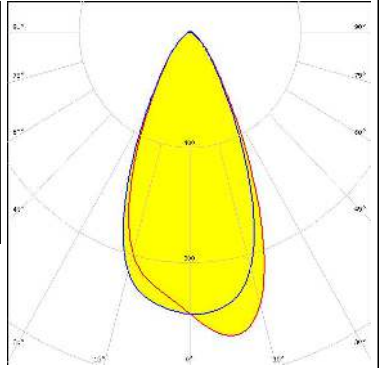
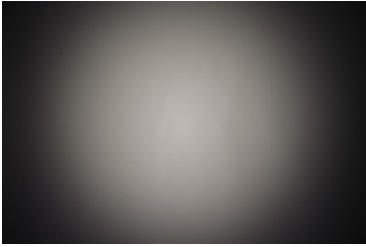
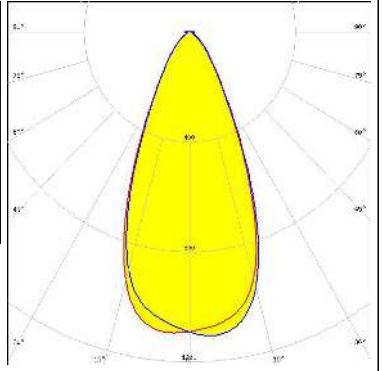
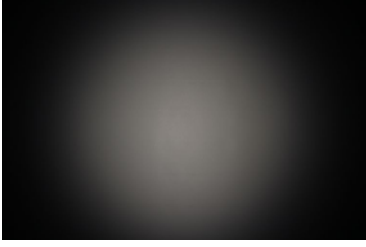
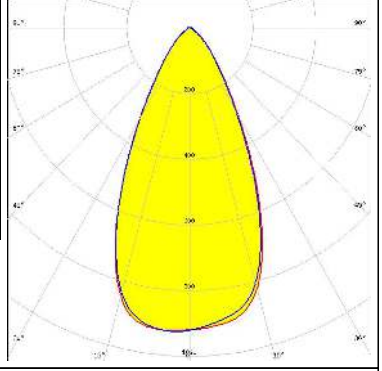
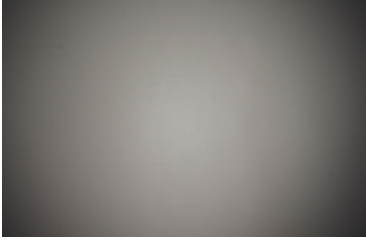
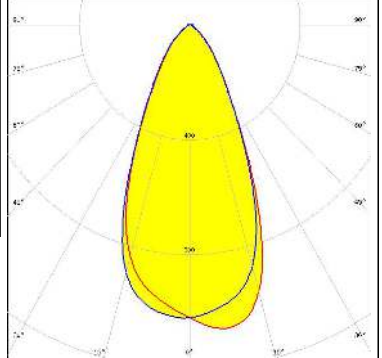

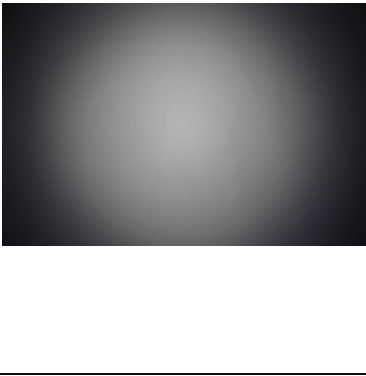
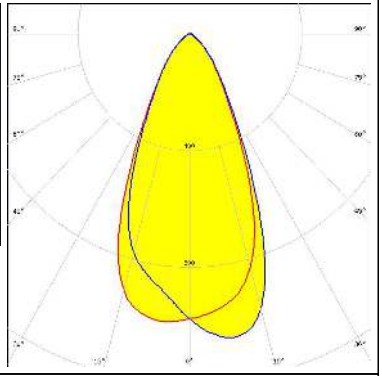
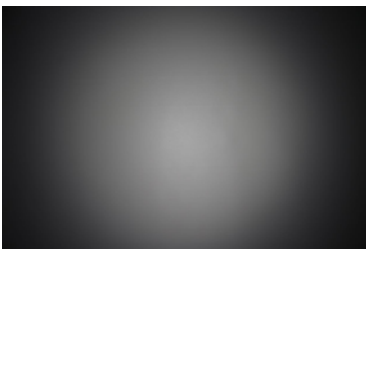
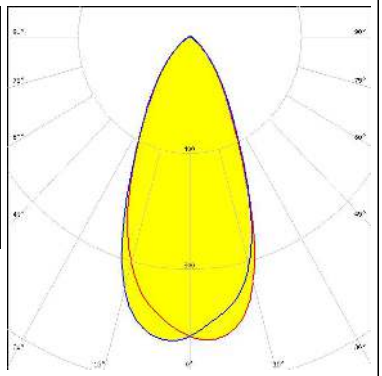

OPTICAL RESULTS (MEASURED):

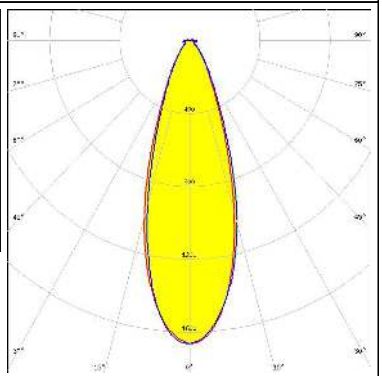
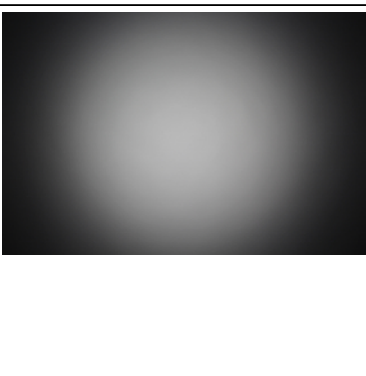
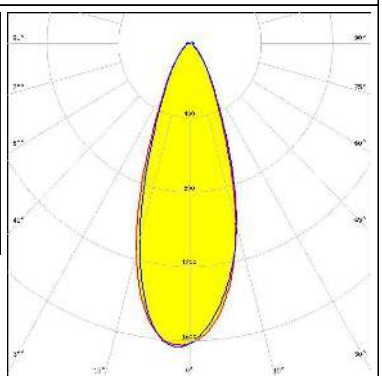
<p>NICHIA</p> <p>LED NVSW3x9A FWHM / FWTM 48.0° / 83.0° Efficiency 78 % Peak intensity 1.1 cd/lm LEDs/each optic 1 Light colour White Required components:</p>		
<p>NICHIA</p> <p>LED NVSxx19B/NVSxx19C FWHM / FWTM 46.0° / 81.0° Efficiency 81 % Peak intensity 1.1 cd/lm LEDs/each optic 1 Light colour White Required components:</p>		
<p>NICHIA</p> <p>LED NWSx229A FWHM / FWTM 51.0° / 87.0° Efficiency 78 % Peak intensity 0.9 cd/lm LEDs/each optic 1 Light colour White Required components:</p>		
<p>OSRAM <small>Opto Semiconductors</small></p> <p>LED OSLON Square EC FWHM / FWTM 48.0° / 86.0° Efficiency 80 % Peak intensity 1.1 cd/lm LEDs/each optic 1 Light colour White Required components:</p>		

OPTICAL RESULTS (MEASURED):

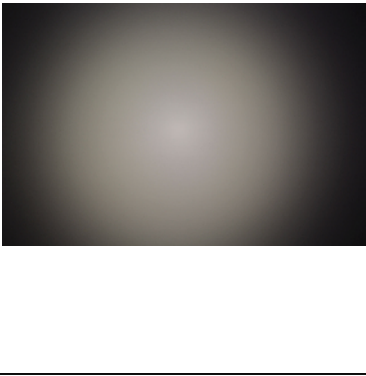
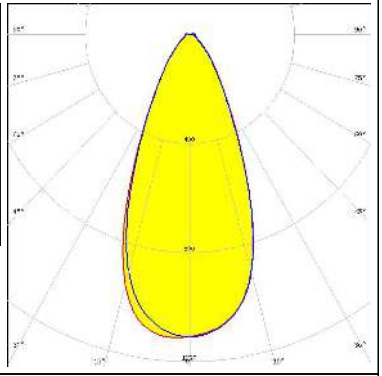
<p>OSRAM Opto Semiconductors</p> <p>LED OSLON Square PC</p> <p>FWHM / FWTM 48.0° / 87.0°</p> <p>Efficiency 79 %</p> <p>Peak intensity 1.1 cd/lm</p> <p>LEDs/each optic 1</p> <p>Light colour White</p> <p>Required components:</p>		
<p>OSRAM Opto Semiconductors</p> <p>LED OSLON SSL 80</p> <p>FWHM / FWTM 46.0° / 88.0°</p> <p>Efficiency 80 %</p> <p>Peak intensity 1.1 cd/lm</p> <p>LEDs/each optic 1</p> <p>Light colour White</p> <p>Required components:</p>		
<p>SAMSUNG</p> <p>LED LH181A</p> <p>FWHM / FWTM 34.0° / 68.0°</p> <p>Efficiency 87 %</p> <p>Peak intensity 1.7 cd/lm</p> <p>LEDs/each optic 1</p> <p>Light colour White</p> <p>Required components:</p>		
<p>SAMSUNG</p> <p>LED LH181B</p> <p>FWHM / FWTM 37.0° / 71.0°</p> <p>Efficiency 90 %</p> <p>Peak intensity 1.6 cd/lm</p> <p>LEDs/each optic 1</p> <p>Light colour White</p> <p>Required components:</p>		

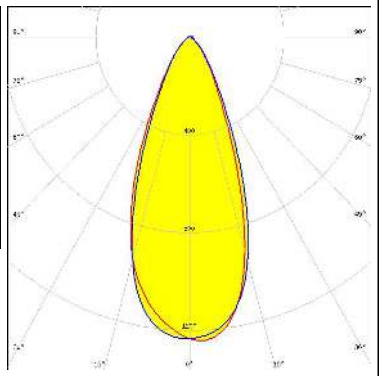
OPTICAL RESULTS (MEASURED):

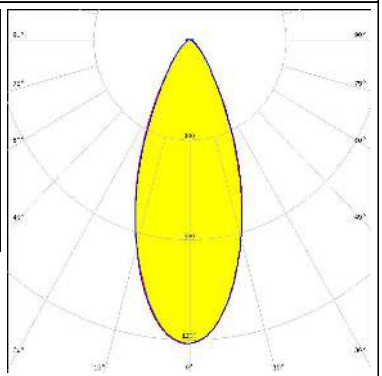
<p> SEOUL SEMICONDUCTOR</p> <p>LED Z5M3</p> <p>FWHM / FWTM 46.0° / 85.0°</p> <p>Efficiency 88 %</p> <p>Peak intensity 1.1 cd/lm</p> <p>LEDs/each optic 1</p> <p>Light colour White</p> <p>Required components:</p>		
<p> SEOUL SEMICONDUCTOR</p> <p>LED Z8Y22P</p> <p>FWHM / FWTM 42.0° / 75.0°</p> <p>Efficiency 78 %</p> <p>Peak intensity 1.2 cd/lm</p> <p>LEDs/each optic 1</p> <p>Light colour White</p> <p>Required components:</p>		
<p> SEOUL SEMICONDUCTOR</p> <p>LED Z8Y50P</p> <p>FWHM / FWTM 42.0° / 77.0°</p> <p>Efficiency 77 %</p> <p>Peak intensity 1.2 cd/lm</p> <p>LEDs/each optic 1</p> <p>Light colour White</p> <p>Required components:</p>		

OPTICAL RESULTS (SIMULATED):

CREE LED

LED J Series 5050 Round LES
 FWHM / FWTM 42.0° / 71.0°
 Efficiency 94 %
 Peak intensity 1.6 cd/lm
 LEDs/each optic 1
 Light colour White
 Required components:

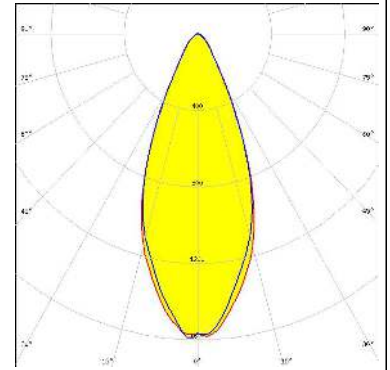

CREE LED

LED J Series 5050 Square LES 6V
 FWHM / FWTM 42.0° / 72.0°
 Efficiency 94 %
 Peak intensity 1.6 cd/lm
 LEDs/each optic 1
 Light colour White
 Required components:

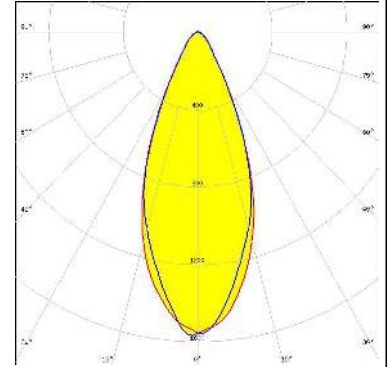

CREE LED

LED XP-G2 HE
 FWHM / FWTM 62.0° / 105.0°
 Efficiency 97 %
 Peak intensity 0.8 cd/lm
 LEDs/each optic 1
 Light colour White
 Required components:

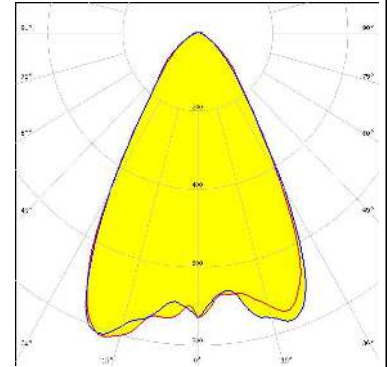

CREE LED

LED XQ-E HI
 FWHM / FWTM 52.0° / 91.0°
 Efficiency 94 %
 Peak intensity 1.1 cd/lm
 LEDs/each optic 1
 Light colour White
 Required components:

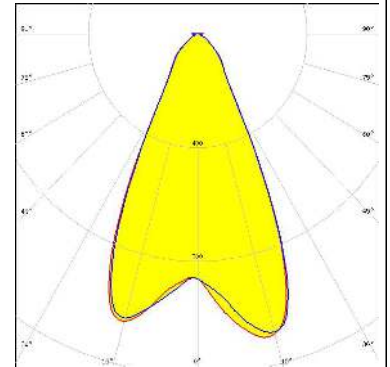



OPTICAL RESULTS (SIMULATED):

<p>LUMILEDS</p> <p>LED LUXEON M/MX FWHM / FWTM 45.0° / 78.0° Efficiency 94 % Peak intensity 1.4 cd/lm LEDs/each optic 1 Light colour White Required components:</p>	
<p>NICHIA</p> <p>LED NCSxE17A FWHM / FWTM 36.0° / 64.0° Efficiency 91 % Peak intensity 1.8 cd/lm LEDs/each optic 4 Light colour White Required components:</p>	
<p>NICHIA</p> <p>LED NV4x144A FWHM / FWTM 54.0° / 96.0° Efficiency 89 % Peak intensity 1 cd/lm LEDs/each optic 1 Light colour White Required components:</p>	
<p>OSRAM <small>Opto Semiconductors</small></p> <p>LED OSCONIQ C 2424 FWHM / FWTM 32.0° / 67.0° Efficiency 94 % Peak intensity 2 cd/lm LEDs/each optic 4 Light colour White Required components:</p>	

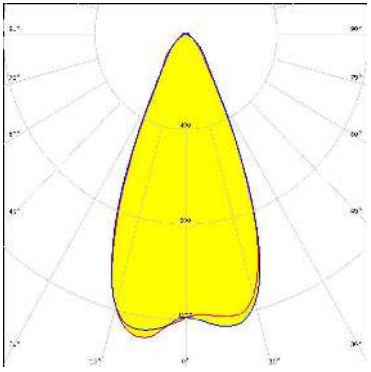
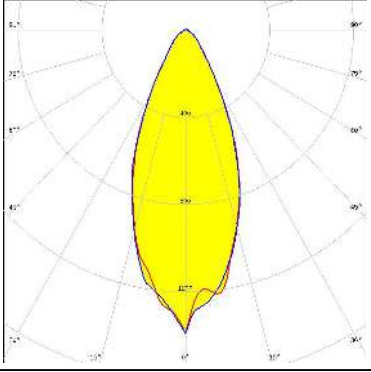
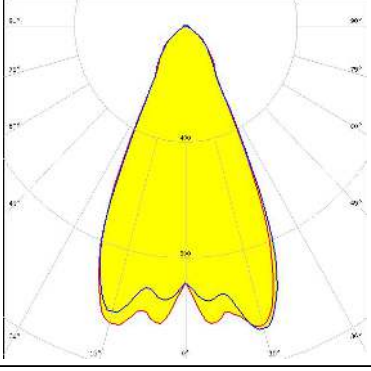
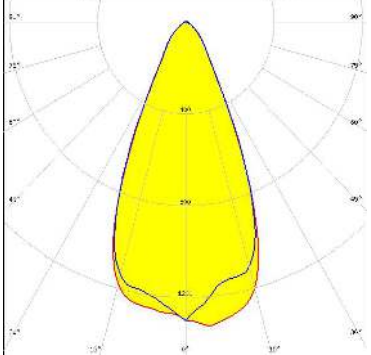
OPTICAL RESULTS (SIMULATED):

<p>OSRAM Opto Semiconductors</p> <p>LED OSCONIQ P 3030</p> <p>FWHM / FWTM 48.0° / 81.0°</p> <p>Efficiency 95 %</p> <p>Peak intensity 1.3 cd/lm</p> <p>LEDs/each optic 1</p> <p>Light colour White</p> <p>Required components:</p>	
<p>OSRAM Opto Semiconductors</p> <p>LED OSCONIQ P 7070</p> <p>FWHM / FWTM 42.0° / 78.0°</p> <p>Efficiency 90 %</p> <p>Peak intensity 1.4 cd/lm</p> <p>LEDs/each optic 1</p> <p>Light colour White</p> <p>Required components:</p>	
<p>OSRAM Opto Semiconductors</p> <p>LED OSLON Square CSSRM2/CSSRM3</p> <p>FWHM / FWTM 50.0° / 90.0°</p> <p>Efficiency 90 %</p> <p>Peak intensity 1.1 cd/lm</p> <p>LEDs/each optic 1</p> <p>Light colour White</p> <p>Required components:</p>	
<p>SEMI SEOUL SEMICONDUCTOR</p> <p>LED MJT 3030</p> <p>FWHM / FWTM 48.0° / 80.0°</p> <p>Efficiency 94 %</p> <p>Peak intensity 1.3 cd/lm</p> <p>LEDs/each optic 1</p> <p>Light colour White</p> <p>Required components:</p>	

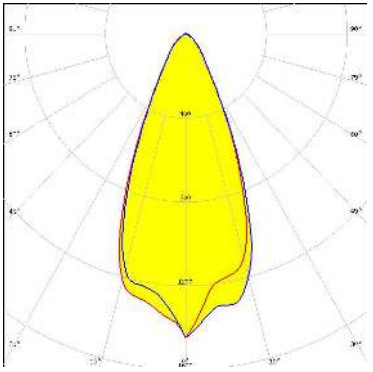
OPTICAL RESULTS (SIMULATED):

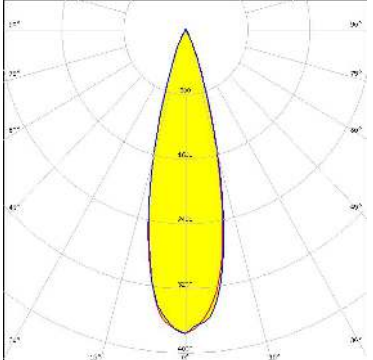
<p> SEOUL SEMICONDUCTOR</p> <p>LED: Z5M4</p> <p>FWHM / FWTM: 45.0° / 77.0°</p> <p>Efficiency: 94 %</p> <p>Peak intensity: 1.5 cd/lm</p> <p>LEDs/each optic: 1</p> <p>Light colour: White</p> <p>Required components:</p>	
<p> SEOUL SEMICONDUCTOR</p> <p>LED: Z8Y22T</p> <p>FWHM / FWTM: 41.0° / 69.0°</p> <p>Efficiency: 94 %</p> <p>Peak intensity: 1.7 cd/lm</p> <p>LEDs/each optic: 1</p> <p>Light colour: White</p> <p>Required components:</p>	

GENERAL INFORMATION:

NOTE: The typical beam angle will be changed by different color, chip size and chip position tolerance. The typical total beam angle is the full angle measured where the luminous intensity is half of the peak value.

MATERIALS:

As part of our continuous research and improvement processes, and to ensure the best possible quality and availability of our products, LEDiL reserves the right to change material grades without notice.

PRODUCT DATA USER AGREEMENT AND DISCLAIMER:

The measured data in the provided downloadable LEDiL Product Datasheets and Mechanical 2D-Drawings is rounded and provided as reference for planning. LEDiL Oy's optical specifications have been verified by conducting performance testing of the products in accordance with the company's quality system. The reported data are averaged results of multiple measurements with typical variation. LEDiL Oy reserves the right to without prior notification make changes and improvements to its products.

LEDiL Oy assumes neither warranty, nor guarantee nor any other liability of any kind for the contents and correctness of the provided data. The provided data has been generated with highest diligence but the provided data may in reality not represent the complete possible variation range of all intrinsic parameters. Therefore, in certain cases a deviation from the provided data could occur.

LEDiL Oy reserves the right to undertake technical changes of its products without further notification which could lead to changes in the provided data. LEDiL Oy assumes no liability of any kind for the possible deviation from any provided data or any other damage resulting from the usage of the provided data.

The user agrees to this disclaimer and user agreement with the download or usage of the provided files.

LEDiL Oy

Joensuunkatu 13
FI-24240 SALO
Finland

LEDiL Inc.

228 West Page Street
Suite D
Sycamore IL 60178
USA

Ledil Optics Technology (Shenzhen) Co., Ltd.

405 , Block B
Casic Motor Building
Shenzhen 518057
P.R.CHINA

Local sales and technical support

[www.ledil.com/
where_to_buy](http://www.ledil.com/where_to_buy)

Shipping locations

Salo, Finland
Hong Kong, China

Distribution Partners

[www.ledil.com/
where_to_buy](http://www.ledil.com/where_to_buy)