

# MAC4DHM

Preferred Device

## Sensitive Gate Triacs

### Silicon Bidirectional Thyristors

Designed for high volume, low cost, industrial and consumer applications such as motor control; process control; temperature, light and speed control.

#### Features

- Small Size Surface Mount DPAK Package
- Passivated Die for Reliability and Uniformity
- Four-Quadrant Triggering
- Blocking Voltage to 600 V
- On-State Current Rating of 4.0 A RMS at 93°C
- Low Level Triggering and Holding Characteristics
- Epoxy Meets UL 94 V-0 @ 0.125 in
- ESD Ratings: Human Body Model, 3B > 8000 V  
Machine Model, C > 400 V
- Pb-Free Packages are Available

#### MAXIMUM RATINGS (T<sub>J</sub> = 25°C unless otherwise noted)

| Rating  | Symbol                                 | Value      | Unit               |
|---|--|------------|--------------------|
| Peak Repetitive Off-State Voltage (Note 1)<br>(T <sub>J</sub> = -40 to 110°C, Sine Wave,<br>50 to 60 Hz, Gate Open) | V <sub>DRM</sub> ,<br>V <sub>RRM</sub> | 600        | V                  |
| On-State RMS Current<br>(Full Cycle Sine Wave, 60 Hz, T <sub>C</sub> = 93°C)  | I <sub>T(RMS)</sub>                    | 4.0        | A                  |
| Peak Non-Repetitive Surge Current<br>(One Full Cycle, 60 Hz, T <sub>J</sub> = 110°C)                                | I <sub>TSM</sub>                       | 40         | A                  |
| Circuit Fusing Consideration (t = 8.3 msec)   | I <sup>2</sup> t                       | 6.6        | A <sup>2</sup> sec |
| Peak Gate Power<br>(Pulse Width ≤ 10 μsec, T <sub>C</sub> = 93°C)   | P <sub>GM</sub>                        | 2.0        | W                  |
| Average Gate Power<br>(t = 8.3 msec, T <sub>C</sub> = 93°C)   | P <sub>G(AV)</sub>                     | 1.0        | W                  |
| Peak Gate Current<br>(Pulse Width ≤ 20 μsec, T <sub>C</sub> = 93°C)   | I <sub>GM</sub>                        | 4.0        | A                  |
| Peak Gate Voltage<br>(Pulse Width ≤ 20 μsec, T <sub>C</sub> = 93°C)   | V <sub>GM</sub>                        | 5.0        | V                  |
| Operating Junction Temperature Range  | T <sub>J</sub>                         | -40 to 110 | °C                 |
| Storage Temperature Range   | T <sub>stg</sub>                       | -40 to 150 | °C                 |

Stresses exceeding Maximum Ratings may damage the device. Maximum Ratings are stress ratings only. Functional operation above the Recommended Operating Conditions is not implied. Extended exposure to stresses above the Recommended Operating Conditions may affect device reliability.

1. V<sub>DRM</sub> and V<sub>RRM</sub> for all types can be applied on a continuous basis. Blocking voltages shall not be tested with a constant current source such that the voltage ratings of the device are exceeded.



**ON Semiconductor**®

<http://onsemi.com>

### TRIACS 4.0 AMPERES RMS 600 VOLTS

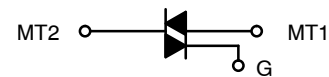

#### MARKING DIAGRAMS

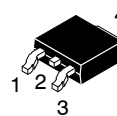

**DPAK  
CASE 369C  
STYLE 6**

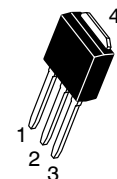
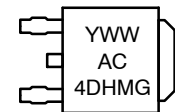

**DPAK-3  
CASE 369D  
STYLE 6**

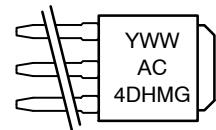

Y = Year  
WW = Work Week  
AC4DHM = Device Code  
G = Pb-Free Package

#### PIN ASSIGNMENT

|   |                 |
|---|-----------------|
| 1 | Main Terminal 1 |
| 2 | Main Terminal 2 |
| 3 | Gate            |
| 4 | Main Terminal 2 |

#### ORDERING INFORMATION

See detailed ordering and shipping information in the package dimensions section on page 2 of this data sheet.

**Preferred** devices are recommended choices for future use and best overall value.

# MAC4DHM

## THERMAL CHARACTERISTICS

| Characteristic  | Symbol  | Max             | Unit |
|---|---|-----------------|------|
| Thermal Resistance, – Junction-to-Case<br>– Junction-to-Ambient<br>– Junction-to-Ambient (Note 2) | $R_{\theta JC}$<br>$R_{\theta JA}$<br>$R_{\theta JA}$ | 3.5<br>88<br>80 | °C/W |
| Maximum Lead Temperature for Soldering Purposes (Note 3)  | $T_L$   | 260             | °C   |

## ELECTRICAL CHARACTERISTICS ( $T_J = 25^\circ\text{C}$ unless otherwise noted; Electricals apply in both directions)

| Characteristic | Symbol | Min | Typ | Max | Unit |
|----------------|--------|-----|-----|-----|------|
|----------------|--------|-----|-----|-----|------|

### OFF CHARACTERISTICS

|   |                        |        |        |             |    |
|---|------------------------|--------|--------|-------------|----|
| Peak Repetitive Blocking Current<br>( $V_D = \text{Rated } V_{DRM}, V_{RRM}, \text{ Gate Open}$ ) | $I_{DRM}$<br>$I_{RRM}$ | –<br>– | –<br>– | 0.01<br>2.0 | mA |
|   |                        |        |        |             |    |

### ON CHARACTERISTICS

|   |          |                          |                              |                          |    |
|---|----------|--------------------------|------------------------------|--------------------------|----|
| Peak On-State Voltage (Note 4) – ( $I_{TM} = \pm 6.0 \text{ A}$ )   | $V_{TM}$ | –                        | 1.3                          | 1.6                      | V  |
| Gate Trigger Current (Continuous dc) ( $V_D = 12 \text{ V}, R_L = 100 \Omega$ )<br>MT2(+), G(+)<br>MT2(+), G(–)<br>MT2(–), G(–)<br>MT2(–), G(+) | $I_{GT}$ | –<br>–<br>–<br>–         | 1.8<br>2.1<br>2.4<br>4.2     | 5.0<br>5.0<br>5.0<br>10  | mA |
| Gate Trigger Voltage (Continuous dc) ( $V_D = 12 \text{ V}, R_L = 100 \Omega$ )<br>MT2(+), G(+)<br>MT2(+), G(–)<br>MT2(–), G(–)<br>MT2(–), G(+) | $V_{GT}$ | 0.5<br>0.5<br>0.5<br>0.5 | 0.62<br>0.57<br>0.65<br>0.74 | 1.3<br>1.3<br>1.3<br>1.3 | V  |
| Gate Non-Trigger Voltage (Continuous dc) – ( $V_D = 12 \text{ V}, R_L = 100 \Omega, T_J = 110^\circ\text{C}$ )<br>All Four Quadrants            | $V_{GD}$ | 0.1                      | 0.4                          | –                        | V  |
| Holding Current ( $V_D = 12 \text{ V}, \text{ Gate Open}, \text{ Initiating Current} = \pm 200 \text{ mA}$ )                                    | $I_H$    | –                        | 1.5                          | 15                       | mA |
| Latching Current<br>MT2(+), G(+)<br>MT2(+), G(–)<br>MT2(–), G(–)<br>MT2(–), G(+)  | $I_L$    | –<br>–<br>–<br>–         | 1.75<br>5.2<br>2.1<br>2.2    | 10<br>10<br>10<br>10     | mA |

### DYNAMIC CHARACTERISTICS

|   |            |    |     |   |                  |
|---|------------|----|-----|---|------------------|
| Rate of Change of Commutating Current<br>( $V_D = 200 \text{ V}, I_{TM} = 1.8 \text{ A}, \text{ Commutating } dv/dt = 1.0 \text{ V}/\mu\text{sec},$<br>$T_J = 110^\circ\text{C}, f = 250 \text{ Hz}, CL = 5.0 \mu\text{fd}, LL = 80 \text{ mH}, RS = 56 \Omega,$<br>$CS = 0.03 \mu\text{fd}$ ) With snubber see Figure 11 | $di/dt(c)$ | –  | 3.0 | – | A/ms             |
| Critical Rate of Rise of Off-State Voltage<br>( $V_D = 0.67 \times \text{Rated } V_{DRM}, \text{ Exponential Waveform},$<br>$\text{ Gate Open}, T_J = 110^\circ\text{C}$ )  | $dv/dt$    | 20 | –   | – | V/ $\mu\text{s}$ |

2. These ratings are applicable when surface mounted on the minimum pad sizes recommended.
3. 1/8" from case for 10 seconds.
4. Pulse Test: Pulse Width  $\leq 2.0 \text{ msec}$ , Duty Cycle  $\leq 2\%$ .

## ORDERING INFORMATION

| Device       | Package Type        | Package | Shipping†          |
|--------------|---------------------|---------|--------------------|
| MAC4DHM-001  | DPAK-3              | 369D    | 75 Units / Rail    |
| MAC4DHM-001G | DPAK-3<br>(Pb-Free) | 369D    | 75 Units / Rail    |
| MAC4DHMT4    | DPAK                | 369C    | 2500 / Tape & Reel |
| MAC4DHMT4G   | DPAK<br>(Pb-Free)   | 369C    | 2500 / Tape & Reel |

†For information on tape and reel specifications, including part orientation and tape sizes, please refer to our Tape and Reel Packaging Specifications Brochure, BRD8011/D.

# MAC4DHM

## Voltage Current Characteristic of Triacs (Bidirectional Device)

| Symbol    | Parameter                                 |
|-----------|---|
| $V_{DRM}$ | Peak Repetitive Forward Off-State Voltage |
| $I_{DRM}$ | Peak Forward Blocking Current             |
| $V_{RRM}$ | Peak Repetitive Reverse Off-State Voltage |
| $I_{RRM}$ | Peak Reverse Blocking Current             |
| $V_{TM}$  | Maximum On-State Voltage                  |
| $I_H$     | Holding Current                           |

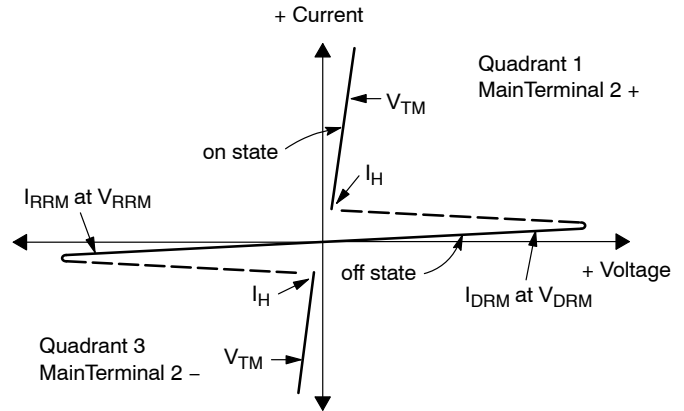

### Quadrant Definitions for a Triac

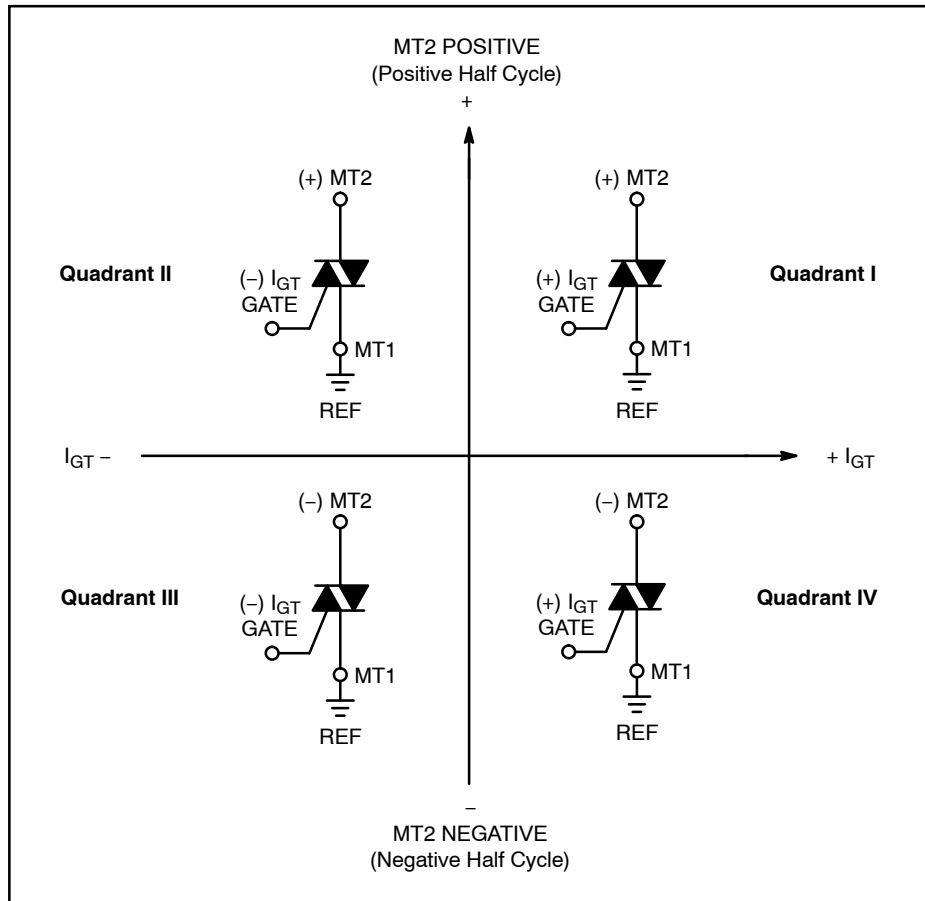

All polarities are referenced to MT1.  
With in-phase signals (using standard AC lines) quadrants I and III are used.

# MAC4DHM

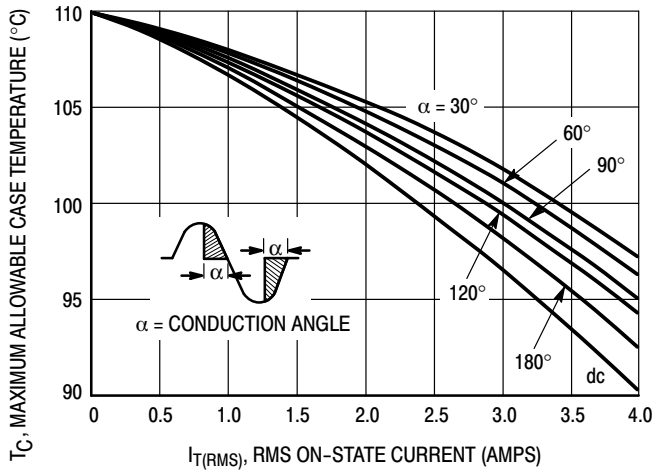

Figure 1. RMS Current Derating

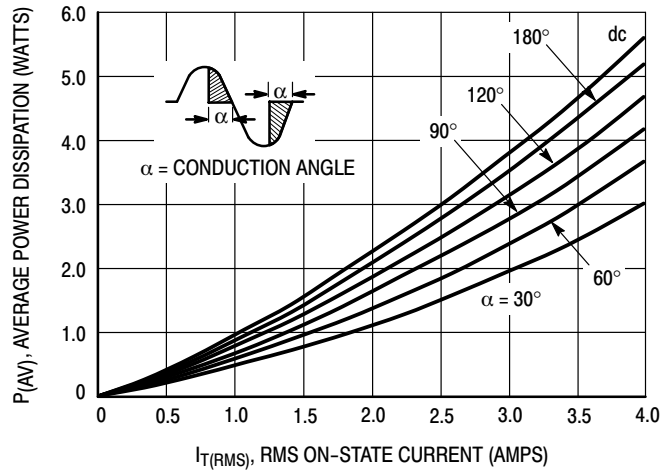

Figure 2. On-State Power Dissipation

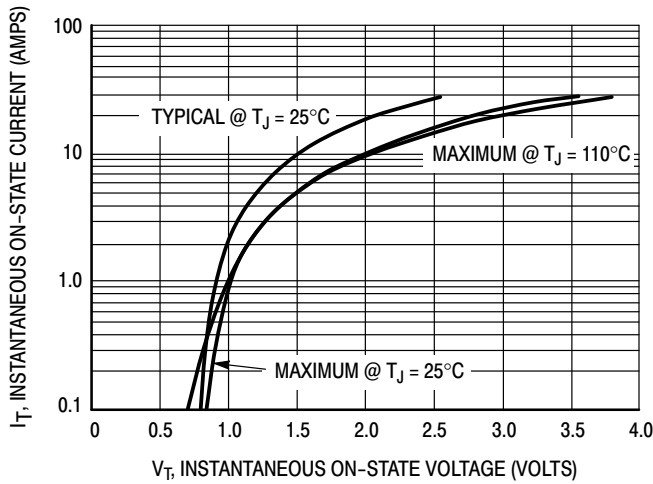

Figure 3. On-State Characteristics

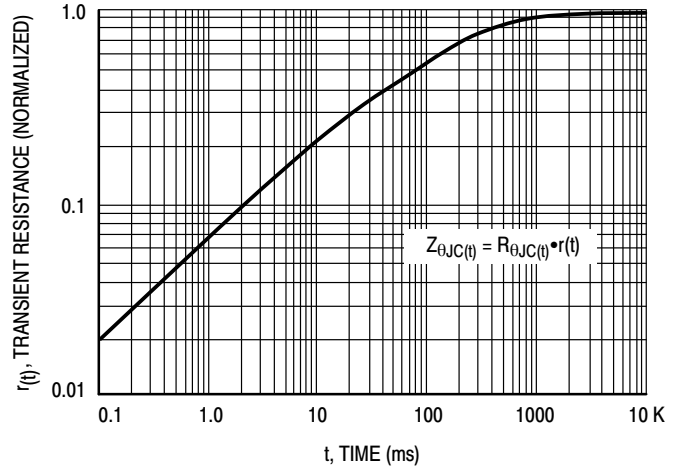

Figure 4. Transient Thermal Response

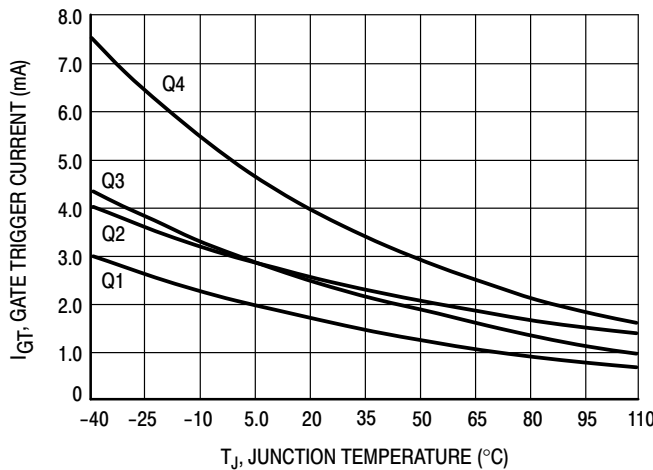

Figure 5. Typical Gate Trigger Current versus Junction Temperature

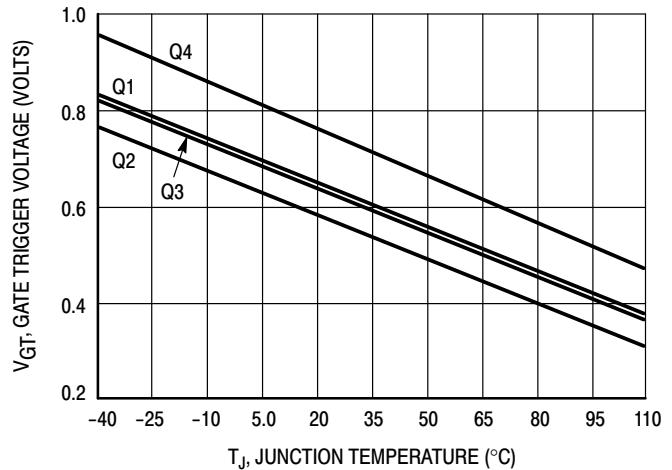
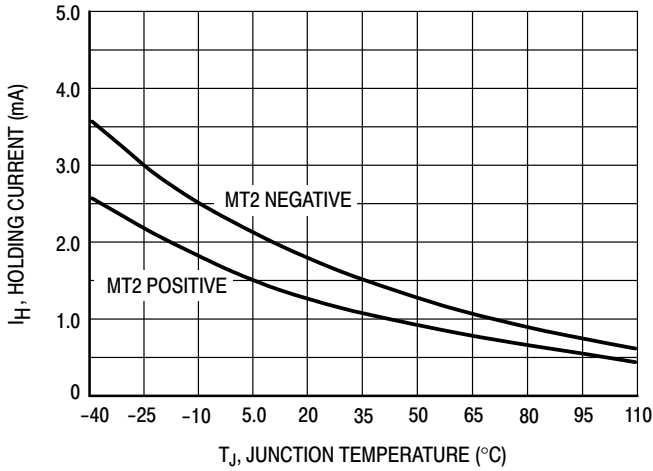
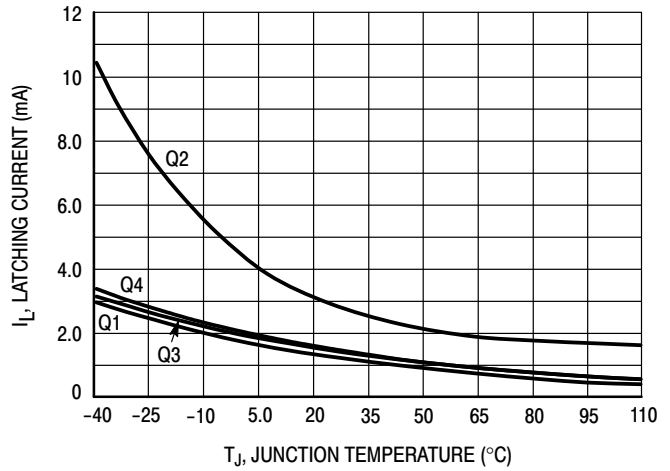

Figure 6. Typical Gate Trigger Voltage versus Junction Temperature

# MAC4DHM



**Figure 7. Typical Holding Current versus Junction Temperature**



**Figure 8. Typical Latching Current versus Junction Temperature**

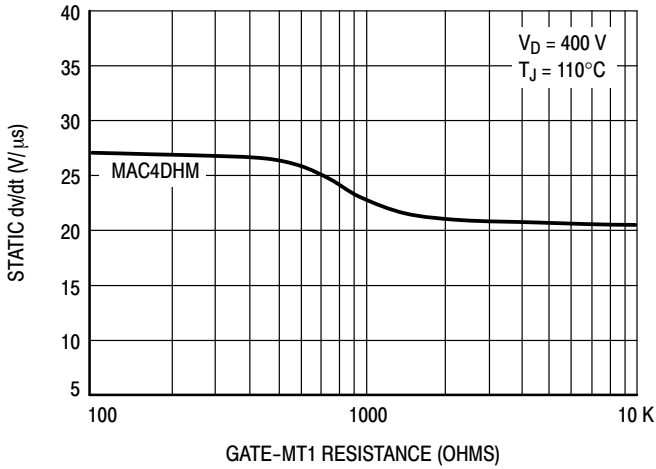

**Figure 9. Minimum Exponential Static dv/dt versus Gate-MT1 Resistance**

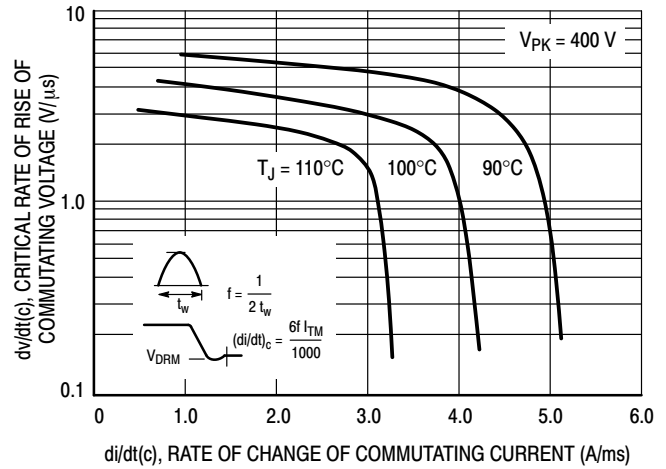

**Figure 10. Typical Critical Rate of Rise of Commutating Voltage**

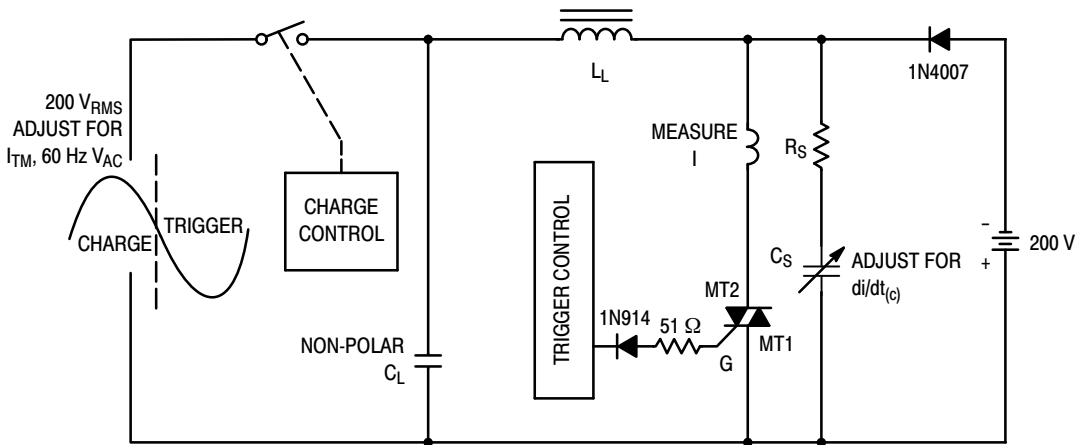

Note: Component values are for verification of rated  $(di/dt)_c$ . See AN1048 for additional information.

**Figure 11. Simplified Test Circuit to Measure the Critical Rate of Rise of Commutating Current  $(di/dt)_c$**

# MAC4DHM

## PACKAGE DIMENSIONS

DPAK  
CASE 369C  
ISSUE O

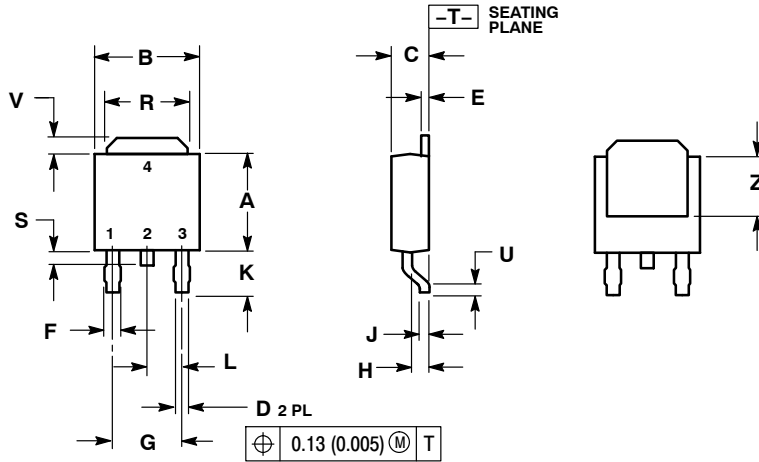

- NOTES:  
1. DIMENSIONING AND TOLERANCING PER ANSI Y14.5M, 1982.  
2. CONTROLLING DIMENSION: INCH.

| DIM | INCHES    |       | MILLIMETERS |      |
|-----|-----------|-------|-------------|------|
|     | MIN       | MAX   | MIN         | MAX  |
| A   | 0.235     | 0.245 | 5.97        | 6.22 |
| B   | 0.250     | 0.265 | 6.35        | 6.73 |
| C   | 0.086     | 0.094 | 2.19        | 2.38 |
| D   | 0.027     | 0.035 | 0.69        | 0.88 |
| E   | 0.018     | 0.023 | 0.46        | 0.58 |
| F   | 0.037     | 0.045 | 0.94        | 1.14 |
| G   | 0.180 BSC |       | 4.58 BSC    |      |
| H   | 0.034     | 0.040 | 0.87        | 1.01 |
| J   | 0.018     | 0.023 | 0.46        | 0.58 |
| K   | 0.102     | 0.114 | 2.60        | 2.89 |
| L   | 0.090 BSC |       | 2.29 BSC    |      |
| R   | 0.180     | 0.215 | 4.57        | 5.45 |
| S   | 0.025     | 0.040 | 0.63        | 1.01 |
| U   | 0.020     | ---   | 0.51        | ---  |
| V   | 0.035     | 0.050 | 0.89        | 1.27 |
| Z   | 0.155     | ---   | 3.93        | ---  |

- STYLE 6:  
PIN 1. MT1  
2. MT2  
3. GATE  
4. MT2

### SOLDERING FOOTPRINT\*

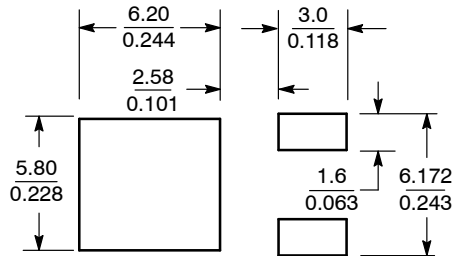

SCALE 3:1  $\left(\frac{\text{mm}}{\text{inches}}\right)$

\*For additional information on our Pb-Free strategy and soldering details, please download the ON Semiconductor Soldering and Mounting Techniques Reference Manual, SOLDERRM/D.

# MAC4DHM

## PACKAGE DIMENSIONS

DKPAK-3  
CASE 369D-01  
ISSUE B

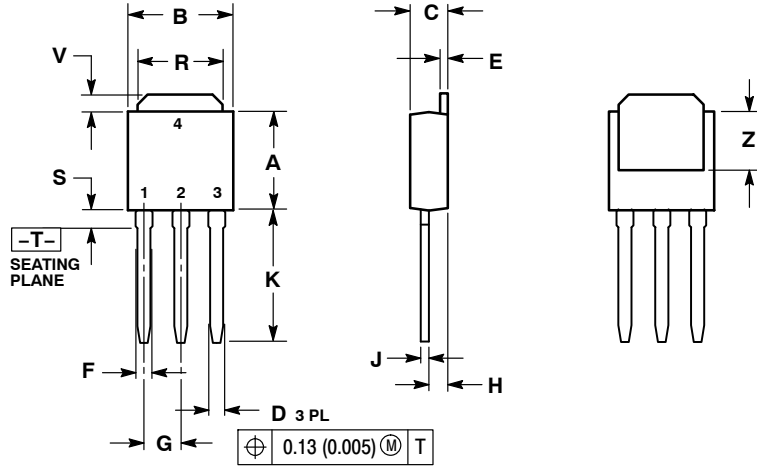

NOTES:

1. DIMENSIONING AND TOLERANCING PER ANSI Y14.5M, 1982.
2. CONTROLLING DIMENSION: INCH.

| DIM | INCHES |       | MILLIMETERS |      |
|-----|--------|-------|-------------|------|
|     | MIN    | MAX   | MIN         | MAX  |
| A   | 0.235  | 0.245 | 5.97        | 6.35 |
| B   | 0.250  | 0.265 | 6.35        | 6.73 |
| C   | 0.086  | 0.094 | 2.19        | 2.38 |
| D   | 0.027  | 0.035 | 0.69        | 0.88 |
| E   | 0.018  | 0.023 | 0.46        | 0.58 |
| F   | 0.037  | 0.045 | 0.94        | 1.14 |
| G   | 0.090  | BSC   | 2.29        | BSC  |
| H   | 0.034  | 0.040 | 0.87        | 1.01 |
| J   | 0.018  | 0.023 | 0.46        | 0.58 |
| K   | 0.350  | 0.380 | 8.89        | 9.65 |
| R   | 0.180  | 0.215 | 4.45        | 5.45 |
| S   | 0.025  | 0.040 | 0.63        | 1.01 |
| V   | 0.035  | 0.050 | 0.89        | 1.27 |
| Z   | 0.155  | ---   | 3.93        | ---  |

STYLE 6:

- PIN 1. MT1
- MT2
- GATE
- MT2

ON Semiconductor and are registered trademarks of Semiconductor Components Industries, LLC (SCILLC). SCILLC reserves the right to make changes without further notice to any products herein. SCILLC makes no warranty, representation or guarantee regarding the suitability of its products for any particular purpose, nor does SCILLC assume any liability arising out of the application or use of any product or circuit, and specifically disclaims any and all liability, including without limitation special, consequential or incidental damages. "Typical" parameters which may be provided in SCILLC data sheets and/or specifications can and do vary in different applications and actual performance may vary over time. All operating parameters, including "Typicals" must be validated for each customer application by customer's technical experts. SCILLC does not convey any license under its patent rights nor the rights of others. SCILLC products are not designed, intended, or authorized for use as components in systems intended for surgical implant into the body, or other applications intended to support or sustain life, or for any other application in which the failure of the SCILLC product could create a situation where personal injury or death may occur. Should Buyer purchase or use SCILLC products for any such unintended or unauthorized application, Buyer shall indemnify and hold SCILLC and its officers, employees, subsidiaries, affiliates, and distributors harmless against all claims, costs, damages, and expenses, and reasonable attorney fees arising out of, directly or indirectly, any claim of personal injury or death associated with such unintended or unauthorized use, even if such claim alleges that SCILLC was negligent regarding the design or manufacture of the part. SCILLC is an Equal Opportunity/Affirmative Action Employer. This literature is subject to all applicable copyright laws and is not for resale in any manner.

### PUBLICATION ORDERING INFORMATION

**LITERATURE FULFILLMENT:**

Literature Distribution Center for ON Semiconductor  
P.O. Box 5163, Denver, Colorado 80217 USA  
Phone: 303-675-2175 or 800-344-3860 Toll Free USA/Canada  
Fax: 303-675-2176 or 800-344-3867 Toll Free USA/Canada  
Email: orderlit@onsemi.com

**N. American Technical Support:** 800-282-9855 Toll Free  
USA/Canada  
**Europe, Middle East and Africa Technical Support:**  
Phone: 421 33 790 2910  
**Japan Customer Focus Center**  
Phone: 81-3-5773-3850

**ON Semiconductor Website:** [www.onsemi.com](http://www.onsemi.com)

**Order Literature:** <http://www.onsemi.com/orderlit>

For additional information, please contact your local Sales Representative