

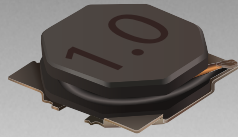

*RoHS COMPLIANT



BOURNS®

Features

- Semi-shielded construction
- Low profile: 1.2 mm
- Inductance range: 0.47 to 22 μ H
- Rated current up to 3.2 A
- RoHS compliant* and halogen free**

 This series is currently available, but not recommended for new designs. The **Model SRN4012T Series** is the recommended alternative.

SRN4012 Series - Semi-shielded Power Inductors

Electrical Specifications @ 25 °C

Bourns Part No.	Inductance @ 100 KHz / 0.1 V		DCR (Ω) Max.	I _{rms} (A)	I _{sat} (A)
	L (μ H)	Tol. %			
SRN4012-R47M	0.47	20	0.03	3.2	4
SRN4012-1R0M	1.0	20	0.045	2.2	2.8
SRN4012-1R5M	1.5	20	0.06	2	2.2
SRN4012-2R2M	2.2	20	0.072	1.9	1.65
SRN4012-3R3M	3.3	20	0.101	1.7	1.4
SRN4012-4R7M	4.7	20	0.114	1.5	1.2
SRN4012-6R8M	6.8	20	0.15	1.3	0.9
SRN4012-100M	10	20	0.204	1.1	0.8
SRN4012-220M	22	20	0.48	0.62	0.5

Soldering Profile

Peak Temperature: 260 °C max.
 Max. Peak Temperature 260 °C: 40 sec. max.
 Max. Time Above 217 °C: 60-150 sec. max.

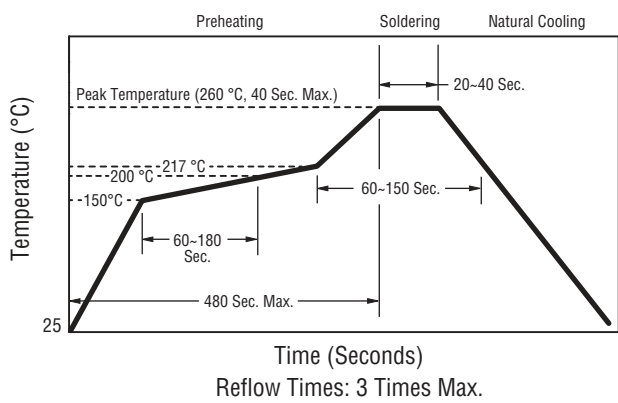

General Specifications

Operating Temperature -40 °C to +125 °C
 (Temperature rise included)
 Storage Temperature .. -40 °C to +125 °C
 Resistance to Solder Heat +260 °C for 40 sec.
 Temperature Rise 40 °C at rated I_{rms}
 Rated Current Inductance drops 30 % at I_{sat}

Materials

Core Ferrite
 Wire Enameled copper
 Terminal Finish Sn
 Coating Magnetic epoxy resin
 Packaging 4000 pcs. per 13-inch reel

Product Dimensions

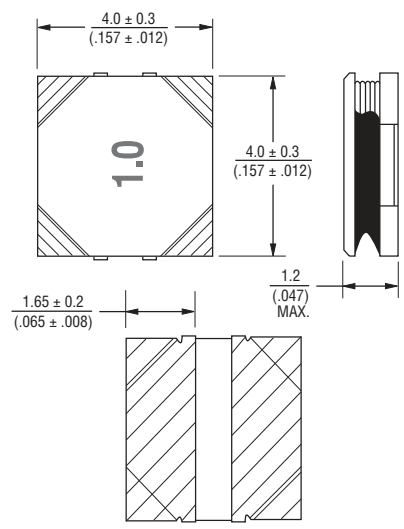

Electrical Schematic

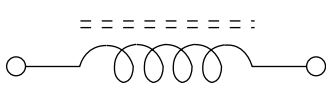

How to Order

SRN4012 - R47M
 Model _____
 Value Code (see table) _____

Recommended Layout

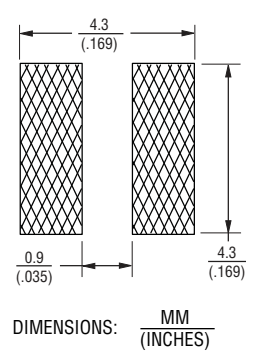

*RoHS Directive 2002/95/EC Jan. 27, 2003 including annex and RoHS Recast 2011/65/EU June 8, 2011.
 **Bourns follows the prevailing definition of "halogen free" in the industry. Bourns considers a product to be "halogen free" if (a) the Bromine (Br) content is 900 ppm or less; (b) the Chlorine (Cl) content is 900 ppm or less; and (c) the total Bromine (Br) and Chlorine (Cl) content is 1500 ppm or less.
 Specifications are subject to change without notice.
 The device characteristics and parameters in this data sheet can and do vary in different applications and actual device performance may vary over time.
 Users should verify actual device performance in their specific applications.

Applications

- DC/DC converters
- Notebook computers
- Digital video cameras
- HDDs
- Cellphones
- Televisions, LCD displays

SRN4012 Series - Semi-shielded Power Inductors

BOURNS®

L vs. IDC

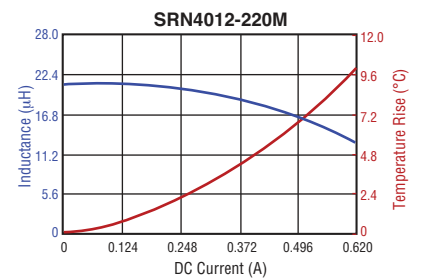
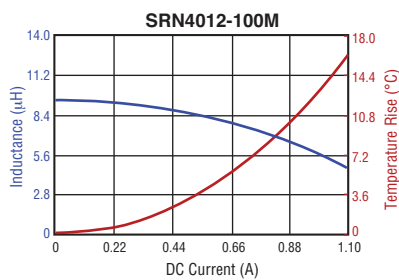
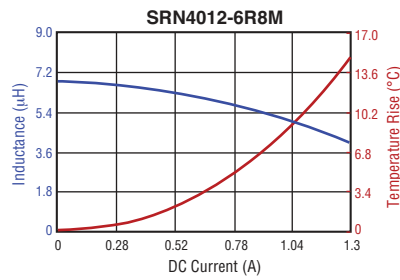
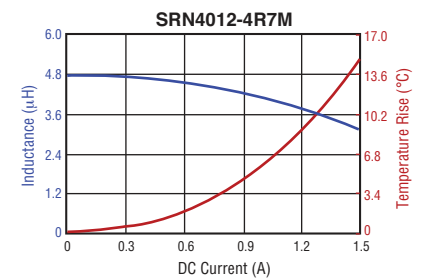
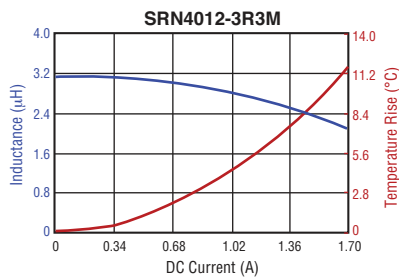
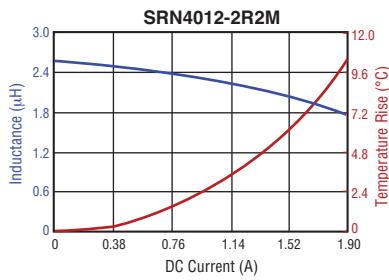
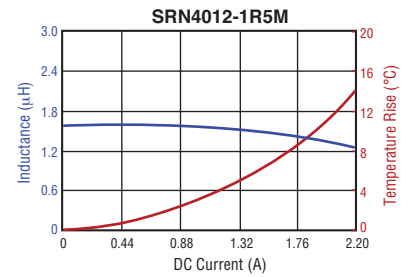
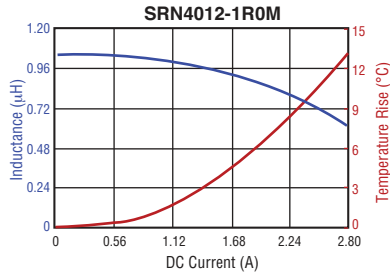
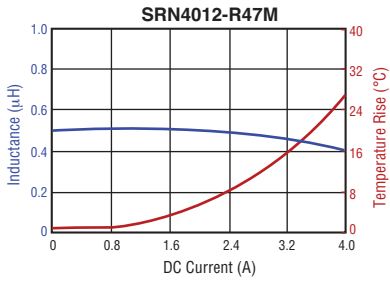

Specifications are subject to change without notice.
 The device characteristics and parameters in this data sheet can and do vary in different applications and actual device performance may vary over time.
 Users should verify actual device performance in their specific applications.

SRN4012 Series - Semi-shielded Power Inductors

BOURNS®

Packaging Specifications

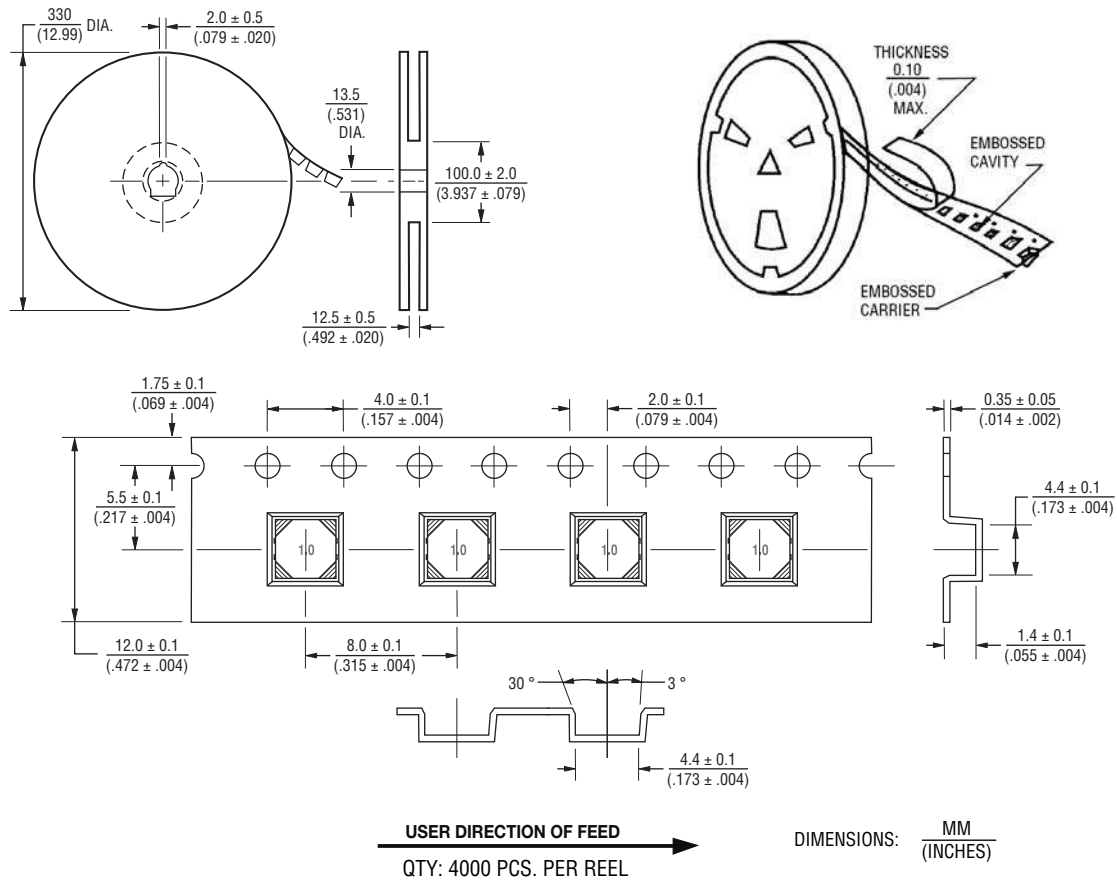

BOURNS®

Asia-Pacific: Tel: +886-2 2562-4117 • Fax: +886-2 2562-4116

EMEA: Tel: +36 88 520 390 • Fax: +36 88 520 211

The Americas: Tel: +1-951 781-5500 • Fax: +1-951 781-5700

www.bourns.com

REV. 01/15

The device characteristics and parameters in this data sheet can and do vary in different applications and actual device performance may vary over time. Specifications are subject to change without notice. Users should verify actual device performance in their specific applications.