

### 34060987-C

Huawei® 34060987 Compatible TAA 10GBase-LR-Lite SFP+ Transceiver (SMF, 1310nm, 2km, LC, DOM)

#### Features:

- SFF-8432 and SFF-8472 Compliance
- Duplex LC Connector
- Uncooled DFB transmitter and PIN receiver
- Single-mode Fiber
- Commercial Temperature 0 to 70 Celsius
- Hot Pluggable
- Metal with Lower EMI
- Excellent ESD Protection
- RoHS Compliant and Lead Free



#### Applications:

- 6GBase/10GBase-LRL Ethernet
- 8x/10x Fibre Channel
- Access, Metro and Enterprise

#### Product Description

This Huawei® 34060987 compatible SFP+ transceiver provides 10GBase-LR throughput up to 2km over single-mode fiber (SMF) using a wavelength of 1310nm via an LC connector. It is guaranteed to be 100% compatible with the equivalent Huawei® transceiver. This easy to install, hot swappable transceiver has been programmed, uniquely serialized and data-traffic and application tested to ensure that it will initialize and perform identically. Digital optical monitoring (DOM) support is also present to allow access to real-time operating parameters. This transceiver is Trade Agreements Act (TAA) compliant. We stand behind the quality of our products and proudly offer a limited lifetime warranty.

ProLabs' transceivers are RoHS compliant and lead-free.

TAA refers to the Trade Agreements Act (19 U.S.C. & 2501-2581), which is intended to foster fair and open international trade. TAA requires that the U.S. Government may acquire only "U.S. – made or designated country end products."



### Absolute Maximum Ratings

Parameter	Symbol	Min.	Typ.	Max.	Unit	Notes
Maximum Supply Voltage	Vcc	-0.5		4	V	1
Storage Temperature	TS	-40		85	°C	2
Operating Case Temperature	Tc	0		70	°C	3
Data Rate	DR	9.83	10.3125	11.3	Gbps	4
Bit Error Rate	BER			10 <sup>-12</sup>		

### Notes:

1. For electrical power interface
2. Ambient Temperature
3. Case Temperature
4. IEEE 802.3ae

### Link Distances

Data Rate	Fiber Type	Distance Range (km)
9.83 –11.3 Gb/s	9/125um SMF	2

### Electrical Characteristics (VCC=3.14V to 3.46V, TC=-0°C to 70°C)

Parameter	Symbol	Min.	Typ.	Max.	Unit	Notes
Power Supply Voltage	Vcc	3.14	3.30	3.46	V	
Power Supply Current	Icc		230	300	mA	
<b>Transmitter</b>						
Differential data input swing	VIN,pp	180		700	mV	
Input differential impedance	RIN		100		Ω	
Transmit Disable Voltage	V <sub>D</sub>	2		Vcc	V	
Transmit Enable Voltage	V <sub>EN</sub>	V <sub>EE</sub>		V <sub>EE</sub> +0.8	V	
<b>Receiver</b>						
Differential data output swing	VOUT, pp	300		850	mV	
Data output rise/fall time (20%-80%)	Tr /Tf	28			ps	
LOS Asset	VLOSA	2		Host_Vcc	V	
LOS De-Assert	VLOSD	Vcc		Vcc+0.5	V	

## Optical Characteristics

Parameter	Symbol	Min.	Typ.	Max.	Unit	Notes
<b>Transmitter</b>						
Output Optical Power	Ptx	-8.2		0.5	dBm	1
Optical Center Wavelength	$\lambda_c$	1260	1310	1355	nm	
Optical Modulation Amplitude	OMA	-5.2			dBm	2
Extinction Ratio	ER	3.5			dB	
Side Mode Suppression Ratio	SMSR	30			dB	
Relative Intensity Noise	RIN			-128	dB/Hz	
Transmitter Dispersion Penalty	TDP			3.2	dB	
Launch Power of OFF Transmitter	Poff			-30	dBm	1
<b>Receiver</b>						
Optical Center Wavelength	$\lambda_c$	1260		1355	nm	
Average Receive Power	Prx	-14.4		0.5	dBm	
Receiver Sensitivity @10.3Gb/s	S			-14.4	dBm	3
Receiver Reflectance	RL			-12	dB	
LOS Assert	LOSA	-30			dBm	
LOS De-Assert	LOSD			-15	dBm	
LOS Hysteresis	LOSH	0.5			dB	

### Notes:

1. Average.
2. According to IEEE 802.3ae requirement.
3. Average. Test the resulting value using the minimum ER value within the defined range:  $BER < 10^{-12}$ , PRBS  $2^{31}-1$ .

## Pin Descriptions

Pin	Symbol	Name/Descriptions	Ref.
1	VeeT	Transmitter Ground (Common with Receiver Ground).	1
2	Tx_Fault	Transmitter Fault.	2
3	Tx_Disable	Transmitter Disable. Laser output disabled on "high" or "open."	3
4	SDA	2-Wire Serial Interface Data Line.	4
5	SCL	2-Wire Serial Interface Clock Line.	4
6	MOD_ABS	Module Absent. Grounded within the module.	4
7	RS0	No connection required.	
8	LOS	Loss of Signal indication. Logic 0 indicates normal operation	5
9	RS1	No connection required.	1
10	VeeR	Receiver Ground (Common with Transmitter Ground).	1
11	VeeR	Receiver Ground (Common with Transmitter Ground).	1
12	RD-	Receiver Inverted Data Out. AC Coupled.	
13	RD+	Receiver Non-Inverted Data Out. AC Coupled.	
14	VeeR	Receiver Ground (Common with Transmitter Ground).	1
15	VccR	Receiver Power Supply	
16	VccT	Transmitter Power Supply	
17	VeeT	Transmitter Ground (Common with Receiver Ground).	1
18	TD+	Transmitter Non-Inverted Data In. AC Coupled.	
19	TD-	Transmitter Inverted Data In. AC Coupled.	
20	VeeT	Transmitter Ground (Common with Receiver Ground).	1

### Notes:

1. Circuit ground is isolated from the chassis ground.
2. Tx\_Fault is the open collector output and should be pulled up with 4.7kΩ-10kΩ on the host board to a voltage between 2V and Vcc+0.3V.
3. Disabled: T<sub>DIS</sub>>2V or open, enabled: T<sub>DIS</sub><0.8V.
4. Should be pulled up with 4.7kΩ-10kΩ on the host board to a voltage between 2V and Vcc+0.3V.
5. LOS is an open collector output and should be pulled up with 4.7kΩ-10kΩ on the host board to a voltage between 2V and Vcc+0.3V. The logic "0" indicates normal operation, and the logic "1" indicates that the receiver signal is lost.

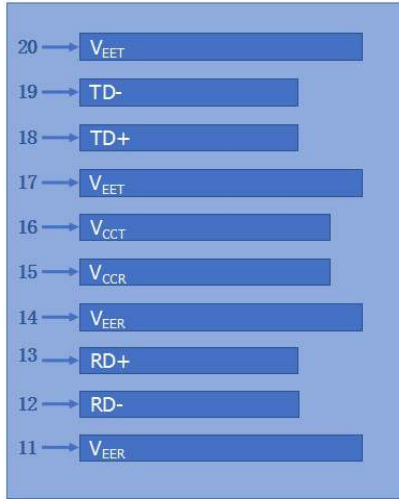

Top of Board

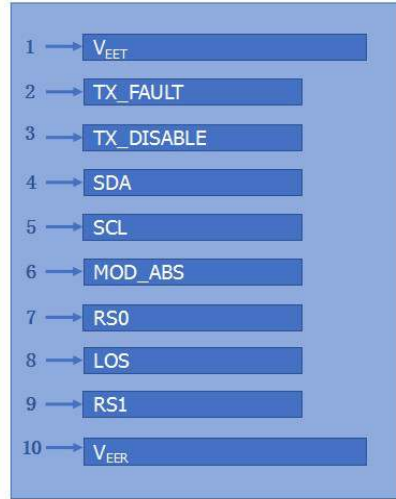

Bottom of Board

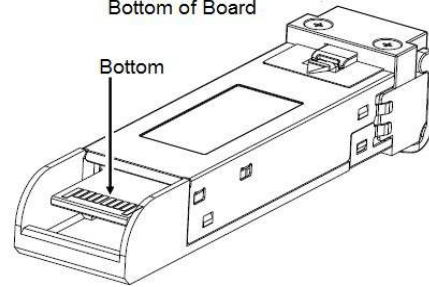
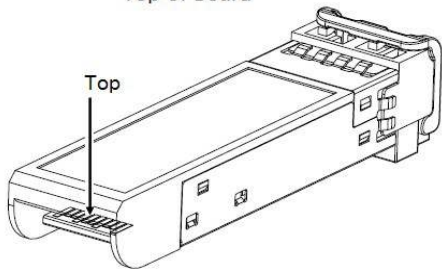

Pin-out of connector Block on Host board

**Block Diagram**

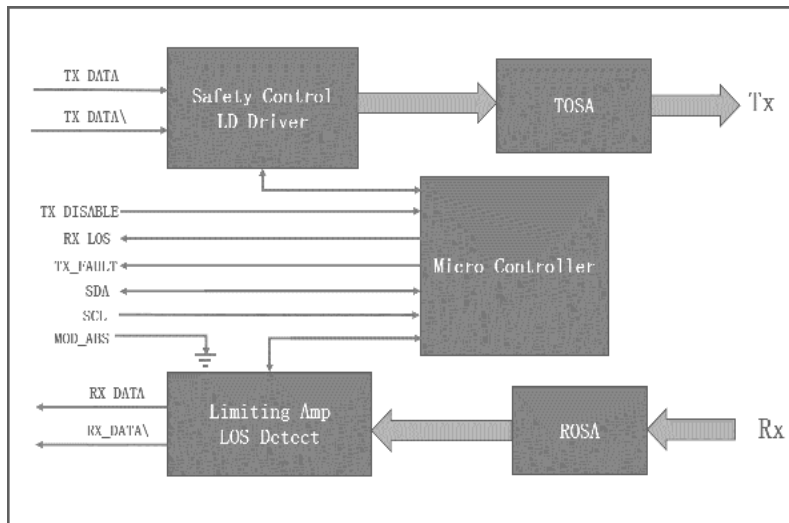

### Mechanical Specifications

Small Form Factor Pluggable (SFP) transceivers are compatible with the dimensions defined by the SFP Multi-Sourcing Agreement (MSA).

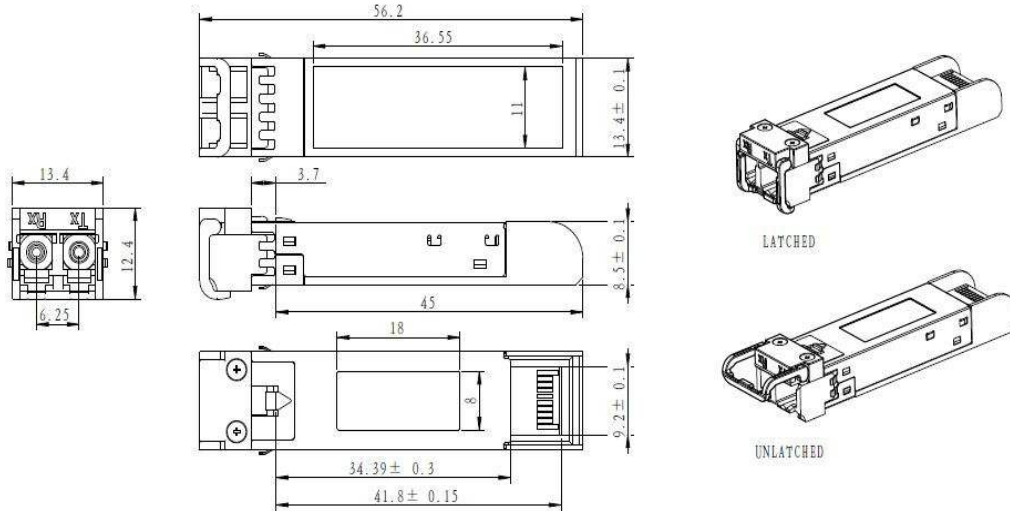

ALL DIMENSIONS ARE ±0.2mm UNLESS OTHERWISE SPECIFIED  
UNIT: mm

### EEPROM Information

EEPROM memory map specific data field description is as below:

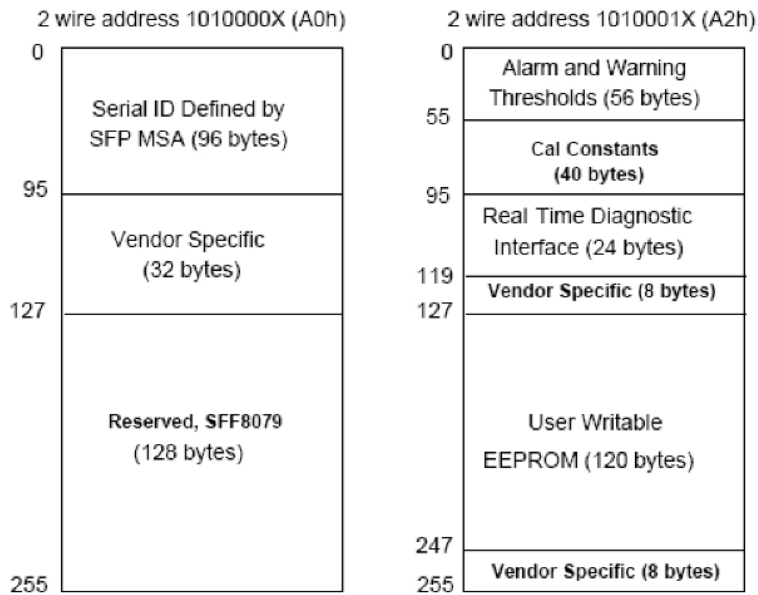

## About ProLabs

Our experience comes as standard; for over 15 years ProLabs has delivered optical connectivity solutions that give our customers freedom and choice through our ability to provide seamless interoperability. At the heart of our company is the ability to provide state-of-the-art optical transport and connectivity solutions that are compatible with over 90 optical switching and transport platforms.

## Complete Portfolio of Network Solutions

ProLabs is focused on innovations in optical transport and connectivity. The combination of our knowledge of optics and networking equipment enables ProLabs to be your single source for optical transport and connectivity solutions from 100Mb to 400G while providing innovative solutions that increase network efficiency. We provide the optical connectivity expertise that is compatible with and enhances your switching and transport equipment.

## Trusted Partner

Customer service is our number one value. ProLabs has invested in people, labs and manufacturing capacity to ensure that you get immediate answers to your questions and compatible product when needed. With Engineering and Manufacturing offices in the U.K. and U.S. augmented by field offices throughout the U.S., U.K. and Asia, ProLabs is able to be our customers best advocate 24 hours a day.



## Contact Information

ProLabs US

Email: [sales@prolabs.com](mailto:sales@prolabs.com)

Telephone: 952-852-0252

ProLabs UK

Email: [salessupport@prolabs.com](mailto:salessupport@prolabs.com)

Telephone: +44 1285 719 600