

16 PIN DIP PHOTOTRANSISTOR PHOTOCOUPLER EL847 Series

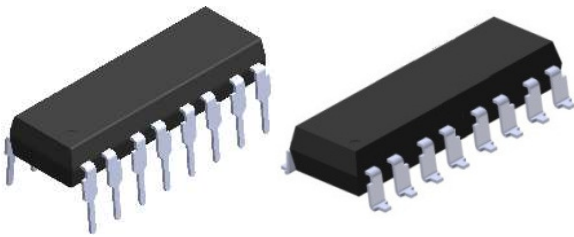

Features:

- Current transfer ratio (CTR: 50~600% at $I_F = 5\text{mA}$, $V_{CE} = 5\text{V}$)
- High isolation voltage between input and output ($V_{iso} = 5000\text{ V rms}$)
- Creepage distance $> 7.62\text{ mm}$
- Operating temperature up to $+110^\circ\text{C}$
- Pb free and RoHS compliant.
- UL and cUL approved (No. E214129)
- VDE approved (No. 132249)
- SEMKO approved
- NEMKO approved
- DEMKO approved
- FIMKO approved
- CQC approved

Schematic

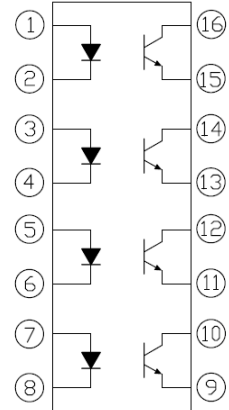

1, 3, 5, 7	Anode
2, 4, 6, 8	Cathode
9, 11, 13, 15	Emitter
10, 12, 14, 16	Collector

Description

The EL847 series devices each of consist of an infrared emitting diodes, optically coupled to a phototransistor detector, and provides four isolated channels. They are packaged in a 16-pin DIP package and available in SMD option.

Applications

- Programmable controllers
- System appliances, measuring instruments
- Telecommunication equipments
- Home appliances, such as fan heaters, etc.
- Signal transmission between circuits of different potentials and impedances

Absolute Maximum Ratings ($T_A=25^{\circ}\text{C}$, for each channel)

	Parameter	Symbol	Rating	Unit
Input	Forward Current	I_F	60	mA
	Peak Forward Current (1us, pulse)	I_{FP}	1	A
	Reverse Voltage	V_R	6	V
	Power Dissipation	P_D	100	mW
Output	Power Dissipation	P_C	150	mW
	Collector Current	I_C	50	mA
	Collector-Emitter Voltage	V_{CEO}	80	V
	Emitter-Collector Voltage	V_{ECO}	7	V
	Total Power Dissipation	P_{TOT}	200	mW
	Isolation Voltage ^{*1}	V_{ISO}	5000	V rms
	Operating Temperature	T_{OPR}	-55 to 110	$^{\circ}\text{C}$
	Storage Temperature	T_{STG}	-55 to 125	$^{\circ}\text{C}$
	Soldering Temperature ^{*2}	T_{SOL}	260	$^{\circ}\text{C}$

Notes:

*1 AC for 1 minute, R.H.= 40 ~ 60% R.H. In this test, pins 1~8 are shorted together, and pins 9~16 are shorted together.

*2 For 10 seconds

Electro-Optical Characteristics (T_A=25°C unless specified otherwise)

Input

Parameter	Symbol	Min.	Typ.*	Max.	Unit	Condition
Forward Voltage	V _F	-	1.2	1.4	V	I _F = 20mA
Reverse Current	I _R	-	-	10	μA	V _R = 4V
Input Capacitance	C _{in}	-	30	250	pF	V = 0, f = 1kHz

Output

Parameter	Symbol	Min.	Typ.*	Max.	Unit	Condition
Collector-Emitter Dark Current	I _{CEO}	-	-	100	nA	V _{CE} = 20V, I _F = 0mA
Collector-Emitter Breakdown Voltage	BV _{CEO}	80	-	-	V	I _C = 0.1mA
Emitter-Collector Breakdown Voltage	BV _{ECO}	7	-	-	V	I _E = 0.1mA

Transfer Characteristics

Parameter	Symbol	Min	Typ.	Max.	Unit	Condition
Current Transfer Ratio	CTR	50	-	600	%	I _F = 5mA, V _{CE} = 5V
Collector-Emitter Saturation Voltage	V _{CE(sat)}	-	0.1	0.2	V	I _F = 20mA, I _C = 1mA
Isolation Resistance	R _{IO}	5×10 ¹⁰	-	-	Ω	V _{IO} = 500Vdc, 40~60% R.H.
Floating Capacitance	C _{IO}	-	0.6	1.0	pF	V _{IO} = 0, f = 1MHz
Cut-off Frequency	f _c	-	80	-	kHz	V _{CE} = 5V, I _C = 2mA R _L = 100Ω, -3dB
Rise Time	t _r	-	6	18	μs	V _{CE} = 2V, I _C = 2mA, R _L = 100Ω
Fall Time	t _f	-	8	18	μs	

* Typical values at T_A= 25°C

Typical Electro-Optical Characteristics Curves

Figure 1. Forward Current vs Forward Voltage

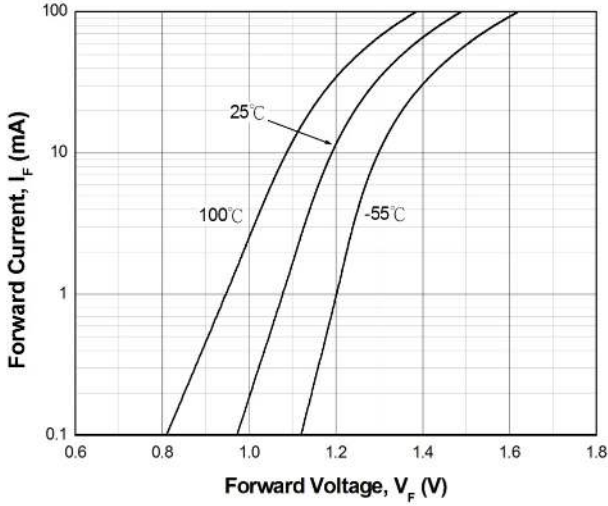

Figure 2. Normalized Collector Current vs Forward Current

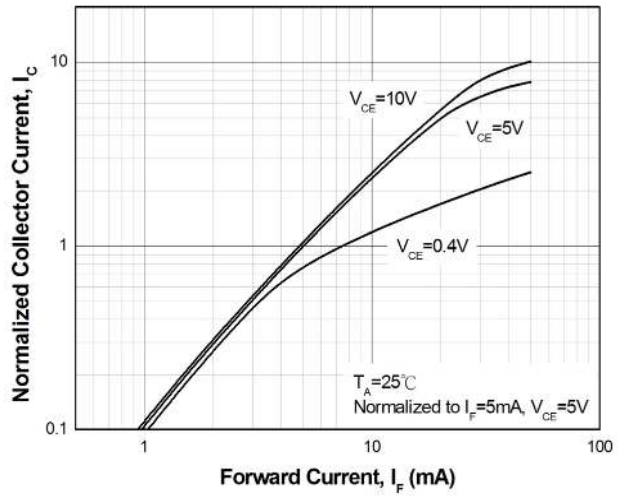

Figure 3. Normalized Current Transfer Ratio vs Forward Current

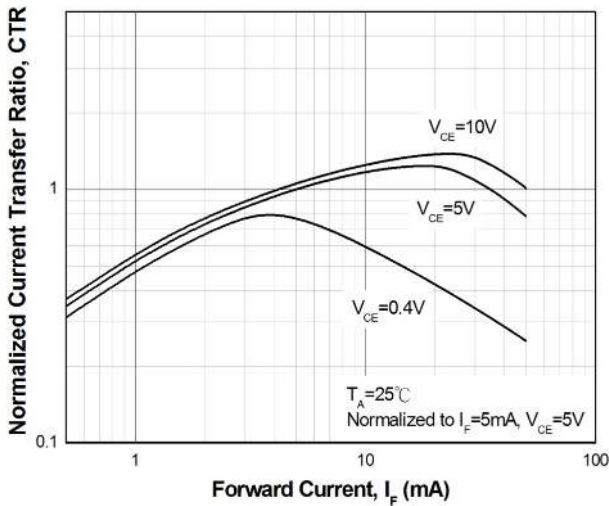

Figure 4. Normalized Collector Current vs Ambient Temperature

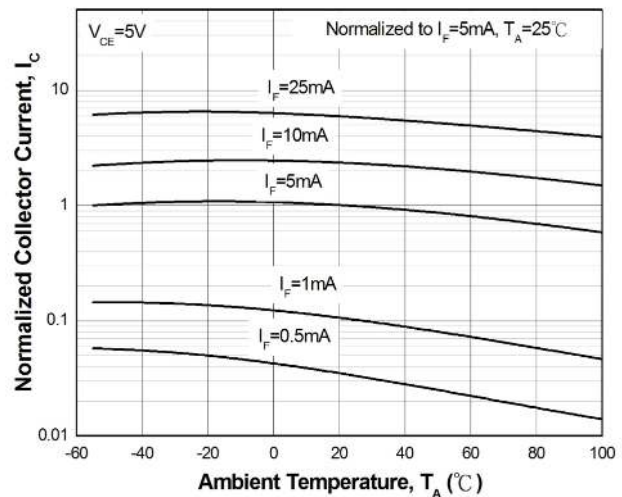

Figure 5. Collector Current vs Collector-Emitter Voltage

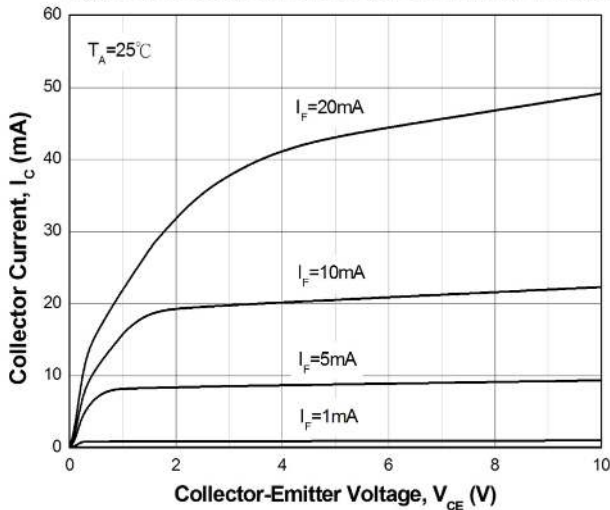

Figure 6. Collector Current vs Collector-Emitter Voltage

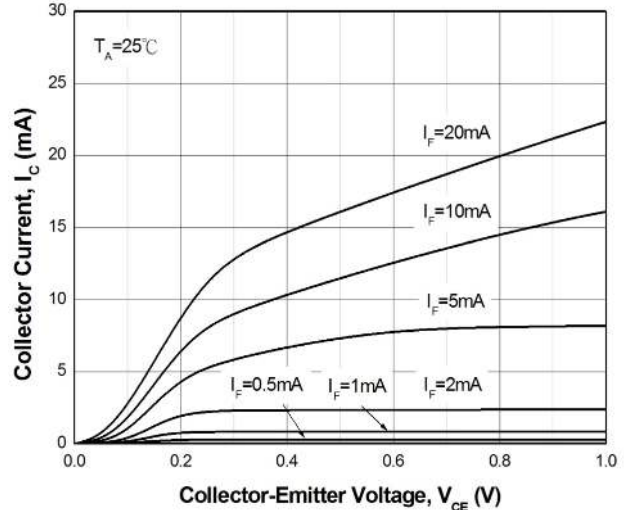

Figure 7. Collector Dark Current vs Ambient Temperature

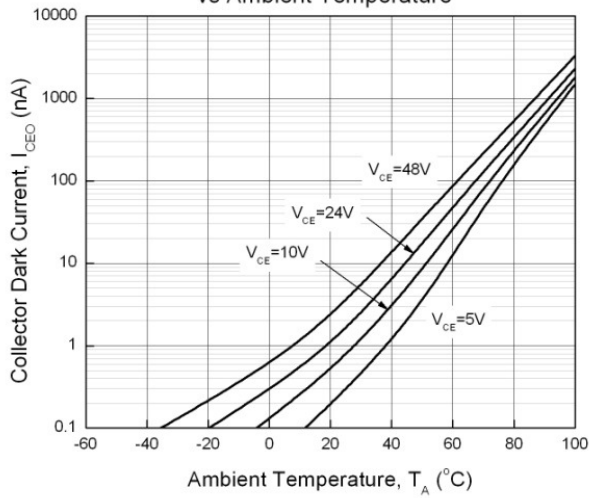

Figure 8. Switching Time vs Load Resistance

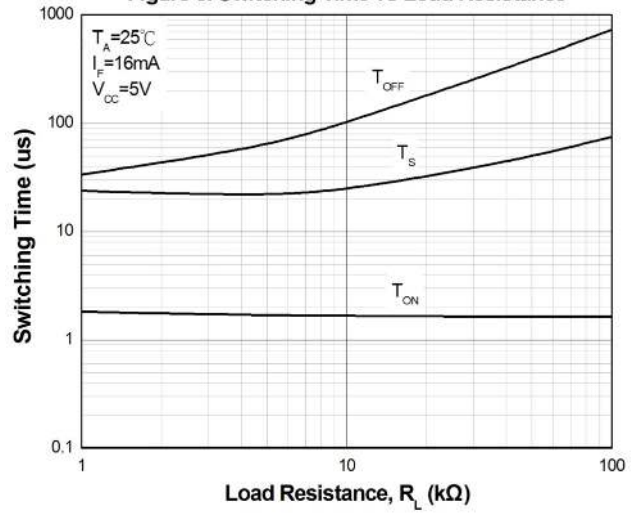

Figure 9. Collector-Emitter Saturation Voltage vs Ambient Temperature

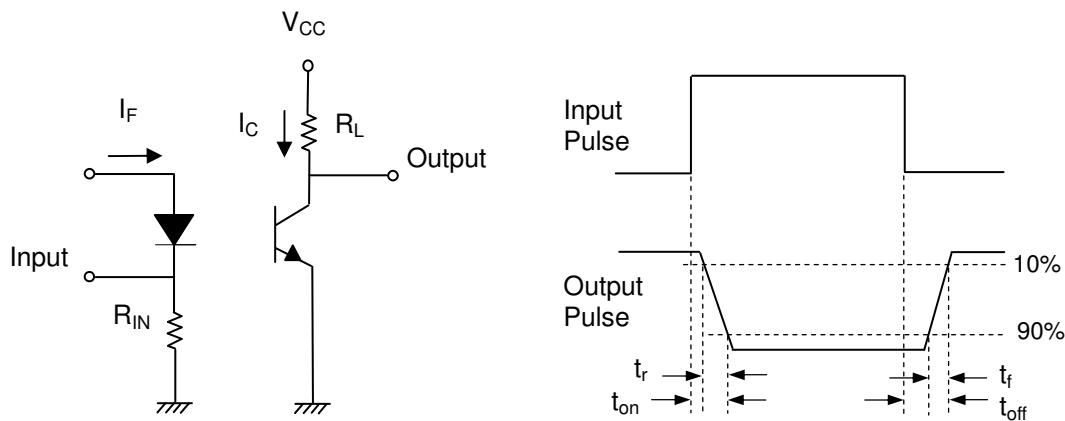
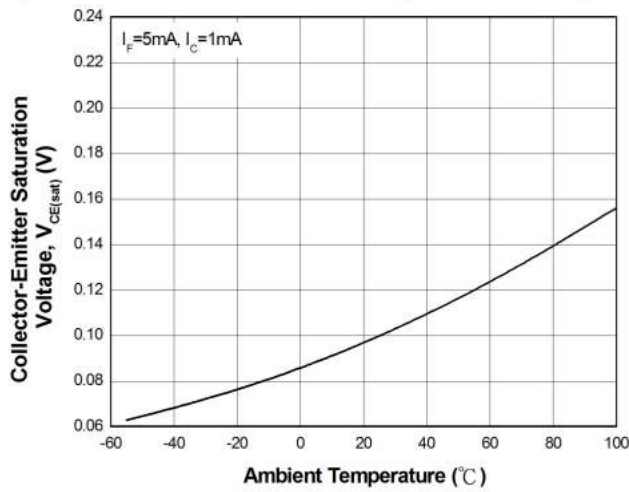
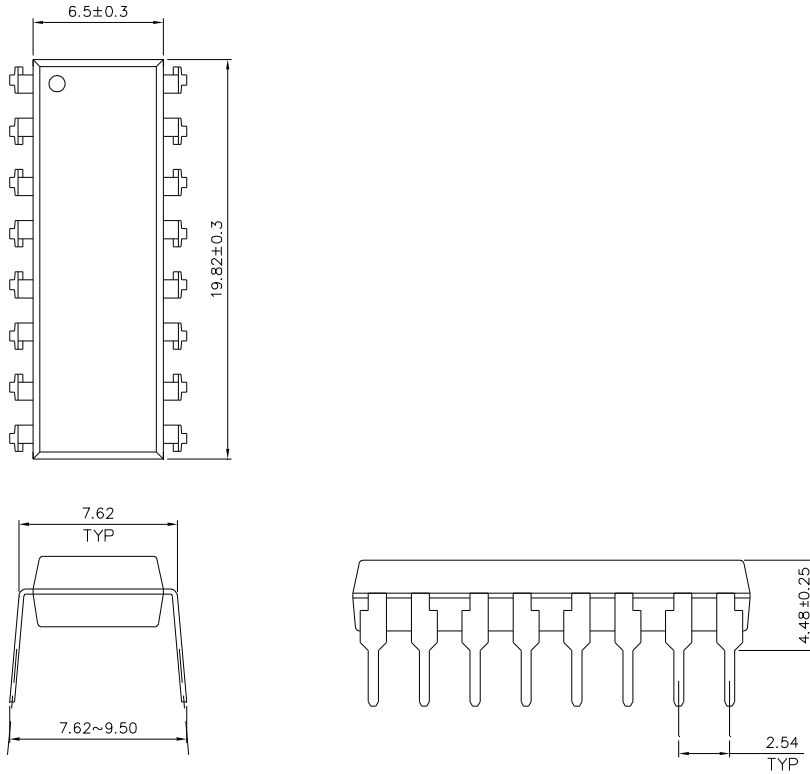

Figure 10. Switching Time Test Circuit & Waveforms

Package Dimension (Dimensions in mm)

Standard DIP Type



Option S Type

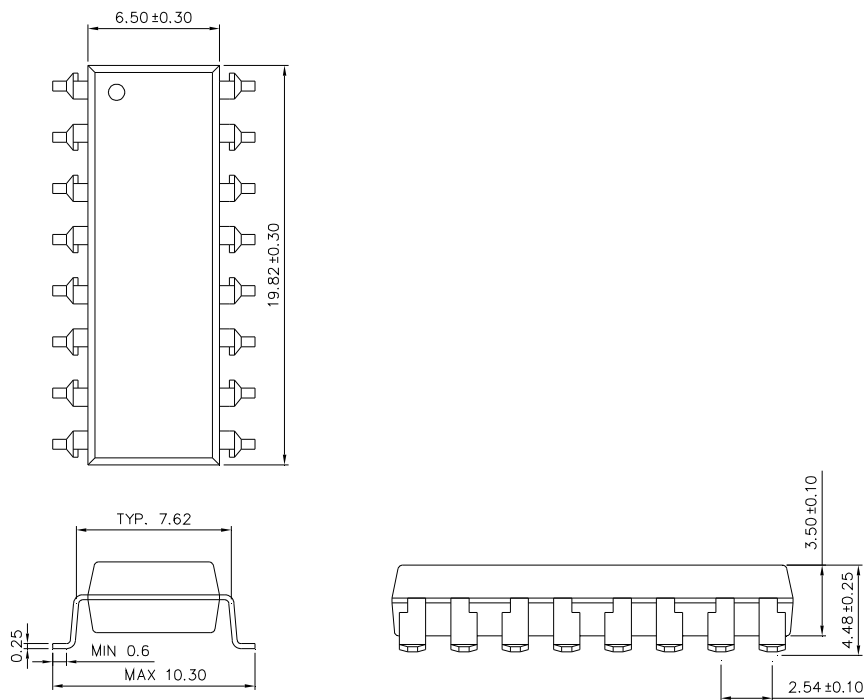

Device Marking

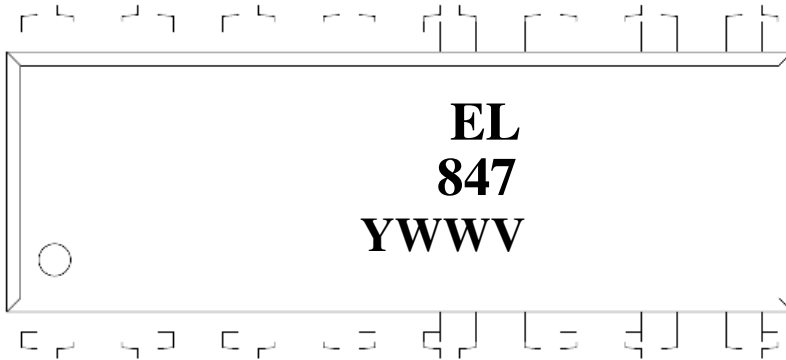

Notes

EL847 denotes Device Number
Y denotes 1 digit Year code
WW denotes 2 digit Week code
V denotes VDE (optional)

Order Information

Part Number

EL847X-V

Note

X = Lead form option (S or none)
V = VDE safety (optional).

Option	Description	Packing quantity
None	Standard DIP-16	20units per tube
S	Surface mount lead form	20units per tube

Precautions for Use

1. Soldering Condition

1.1 (A) Maximum Body Case Temperature Profile for evaluation of Reflow Profile

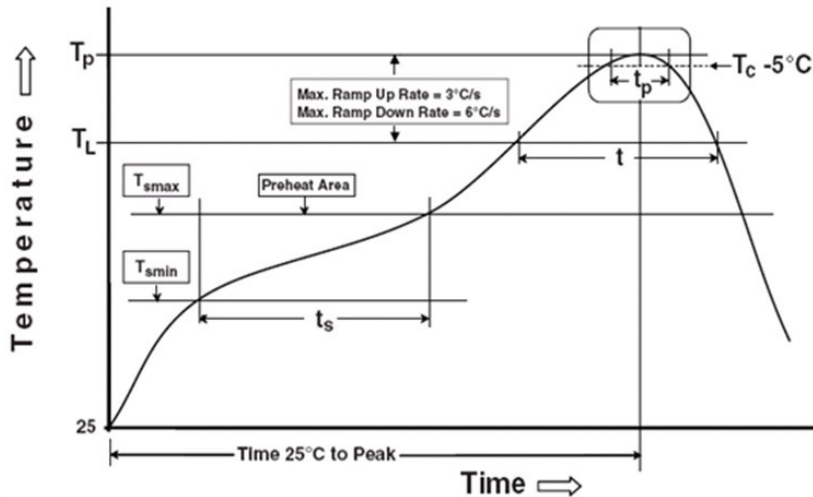

Note:

Reference: IPC/JEDEC J-STD-020D

Preheat

Temperature min (T_{smin})	150 °C
Temperature max (T_{smax})	200 °C
Time (T_{smin} to T_{smax}) (t_s)	60-120 seconds
Average ramp-up rate (T_{smax} to T_p)	3 °C/second max

Other

Liquidus Temperature (T_L)	217 °C
Time above Liquidus Temperature (t_L)	60-100 sec
Peak Temperature (T_p)	260 °C
Time within 5 °C of Actual Peak Temperature: $T_p - 5^\circ\text{C}$	30 s
Ramp- Down Rate from Peak Temperature	6 °C /second max.
Time 25 °C to peak temperature	8 minutes max.
Reflow times	3 times

DISCLAIMER

1. Above specification may be changed without notice. EVERLIGHT will reserve authority on material change for above specification.
2. When using this product, please observe the absolute maximum ratings and the instructions for using outlined in these specification sheets. EVERLIGHT assumes no responsibility for any damage resulting from use of the product which does not comply with the absolute maximum ratings and the instructions included in these specification sheets.
3. These specification sheets include materials protected under copyright of EVERLIGHT corporation. Please don't reproduce or cause anyone to reproduce them without EVERLIGHT's consent.