

Han Modular frame 10 housing 3module a-c

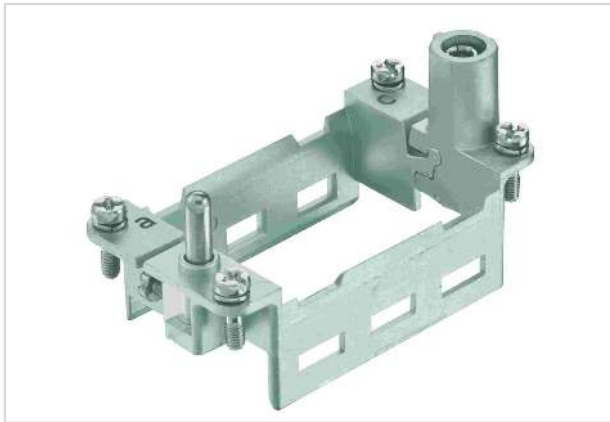

Image is for illustration purposes only. Please refer to product description.

Part number	09 14 010 0313
Specification	Han Modular frame 10 housing 3module a-c
HARTING eCatalogue	https://b2b.harting.com/09140100313

Identification

Category	Accessories
Series	Han-Modular®
Type of accessory	Hinged frame
Description of the accessory	for 3 modules a ... c
Features	Conductor cross-section PE (power side) 4 ... 10 mm ² Conductor cross-section PE (signal side) 1 ... 2.5 mm ²

Version

Size	10 B
------	------

Technical characteristics

Limiting temperature	-40 ... +125 °C
Mating cycles	≥500

Material properties

Material	Zinc die-cast
RoHS	compliant with exemption
RoHS exemptions	6(c): Copper alloy containing up to 4 % lead by weight
ELV status	compliant with exemption
China RoHS	50
REACH Annex XVII substances	Not contained
REACH ANNEX XIV substances	Not contained
REACH SVHC substances	Yes



Pushing Performance
Since 1945

Material properties

REACH SVHC substances	Lead
ECHA SCIP number	564b7d75-7bf6-4cfb-acb1-2168eb61b675
California Proposition 65 substances	Yes
California Proposition 65 substances	Lead

Specifications and approvals

Specifications	IEC 60664-1 IEC 61984
UL / CSA	UL 1977 ECBT2.E235076
Approvals	DNV GL

Commercial data

Packaging size	2
Net weight	50 g
Country of origin	Germany
European customs tariff number	85389099
GTIN	5713140020863
ETIM	EC002312
eCl@ss	27440206 Module carrier frame for industrial connectors