

Single Port RJ45 Connector

AR11-3827I

- 10/100/1000 Base-T Gigabit Ethernet Application
- Impedance: 100OHMS
- RJ45 jack cavity conforms to FCC rules and regulations Part 68, SUB Part F
- Industrial Temp: -40°C to +85°C
- Contact Factory for Standard Operating Temp.
- Available in other Circuit Designs
- Optional Gold Plating Thickness
- Full EMI Fingers



Electrical Specifications @ 25°C

| Part Number | OCL(uH Min) @ 100kHz, 0.1V | Turns Ratio chip: cable (±2%) | Insertion Loss (dB Max) | Return Loss (dB Min) | | |
|-------------|-------------------------------|-------------------------------------|----------------------------|-------------------------|--------------------|----------|
| | With 8mA DC Bias | | 1-100MHz | 1-30MHz | 30-60MHz | 60-80MHz |
| AR11-3827I | 350 | 1CT:1CT | -1.0 | -18 | -18-20Log(F/30MHz) | -12 |

Electrical Specifications @ 25°C

| Cross Talk (dB Min) | | | | | CMR (dB Min) | | | | | CDMR (dB Min) | | | | | HI-POT (Vrms) |
|------------------------|-------|-------|-------|--------|-----------------|-------|-------|-------|--------|------------------|-------|-------|-------|--------|------------------|
| 0.5-1MHz | 10MHz | 30MHz | 50MHz | 100MHz | 0.3-1MHz | 10MHz | 30MHz | 60MHz | 100MHz | 0.3-1MHz | 10MHz | 30MHz | 60MHz | 100MHz | 0.5mA/2Sec. |
| -50 | -50 | -40 | -35 | -30 | -50 | -47 | -42 | -37 | -30 | -50 | -50 | -50 | -45 | -40 | 1500 |

All specifications subject to change without notice.

MECHANICAL

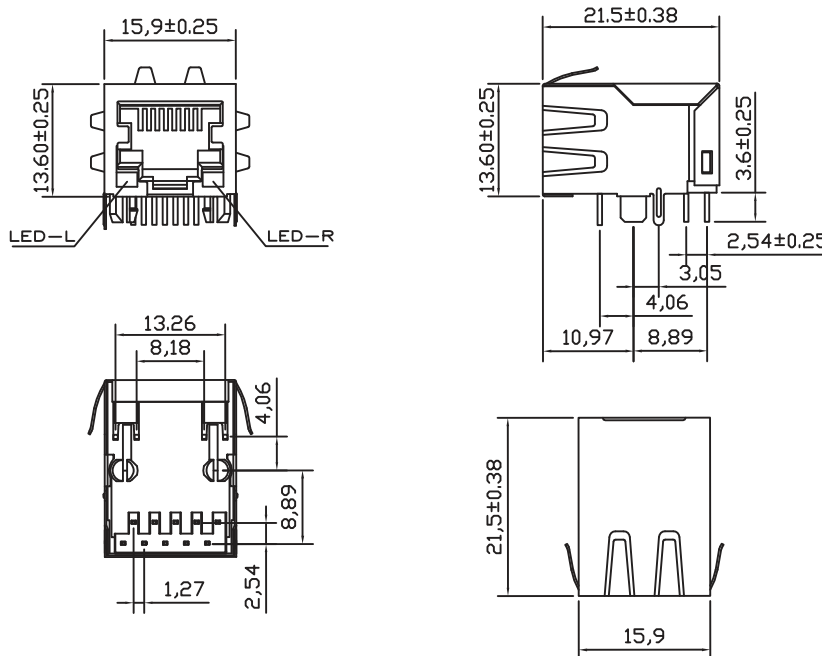

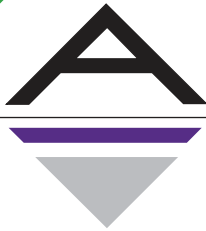

SCHEMATICS

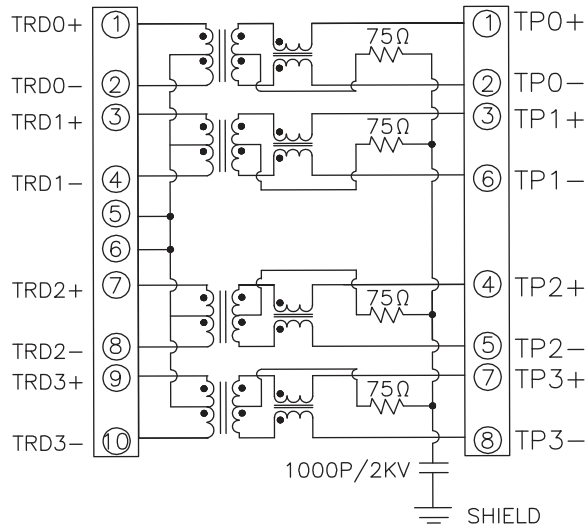

| Standard LED | Wavelength | Forward*V(MAX) | TYP |
|--------------|------------|----------------|------|
| Green | 565nm | 2.5v | 2.2v |
| Yellow | 590nm | 2.5v | 2.1v |

With a forward current of 20mA

PCB LAYOUT

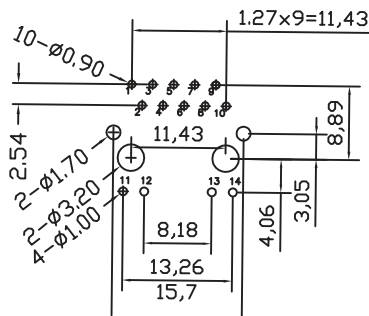

NOTES

- Shield- 0.25mm THICKNESS BRASS C2680 H. PLATING NICKEL 20u"
- Housing- Standard Material Nylon66, Glass filled Polyester UL94V-0 Standard Color Black.
- RJ Terminal- Plastic: Nylon 66, UL94V-0, Standard Color Black.
Pin: 0.35mm Thickness Phos-Bronze C5210 EH. Plating: Nickel 40u"-60u" for all and Sn 100%, and 6u" Gold Plating.
- Input Terminal: Plastic PBT, Glass Filled, UL94V-0, Standard Color Black.
Pin: 0.35mm SUS430
Plating: Nickel 40u"-60u" for all and Sn 100%.