

# 40 Amp Power Relay with AC Coils & Low Case Profile QC Terminals

**PTRA**



## FEATURES

- Power PCB Relay with AC Coils
- 40 Amp 240 VAC Resistive UL Rating
- 2 HP 250 VAC Rating
- UL Class F Insulation Standard
- Meets UL 508 and UL 873 Spacing
- RoHS Compliant

## UL / CUL Ratings

**UL** us **E93379**

Load Type	Voltage	Cycles	1 Form A (SPST-NO)	1 Form B (SPDT-NC)	1 Form C (SPDT)	
					NO	NC
General Purpose	240 VAC	6,000	30 A	20 A	30 A	20 A
	277 VAC	6,000	30 A	20 A	30 A	20 A
	280 VAC	6,000	5 A	5 A	5 A	5 A
Resistive	240 VAC	250,000	40 A	30 A	40 A	30 A
	240 VAC		20 A	—	20 A	—
	277 VAC		25 A	—	25 A	—
	30 VDC		40 A	30 A	40 A	30 A
Motor	250 VAC	30,000	2 HP	1.5 HP	2 HP	1.5 HP
	120 VAC	30,000	1 HP	—	1 HP	—
Ballast	280 VAC	6,000	5 A	5 A	5 A	5A

## CONTACT DATA

Material	AgCdO, AgSnO <sub>2</sub> In <sub>2</sub> O <sub>3</sub>	
Initial Contact Resistance	30 mΩ Max. @ 1 A, 6 VDC	
Maximum Switching Voltage	110 VDC, 300 VAC	
Maximum Switching Current	40 A	
Maximum Switching Power	1,200 W, 10,000 VA	
Service Life	Mechanical	1 x 10 <sup>7</sup> Operations
	Electrical	1 x 10 <sup>5</sup> Operations

\*6 pin version meets UL 508

5 pin (-1) version meets UL 508 and UL 873 spacing - 3.18 mm through air, 6.36 mm over surface.

## Additional UL / CUL Ratings for AgSnO Contacts

Load Type	Voltage	Cycles	Temp.	1 Form A	1 Form C (SPDT)	
					NO	NC
Resistive	277/250 VAC	30,000	40°C	30 A	30 A	30 A

## ORDERING INFORMATION

Example:	PTRA	-1C	-12	S	-1	-X
Model:	<b>PTRA</b>					
Contact Form:	<b>1A, 1B, 1C</b>					
Coil Voltage:	<b>12, 24, 110, 120, 220, 240, 277</b>					
Enclosure:	<b>Nil:</b> Open Frame; <b>S:</b> Sealed Plastic Case					
Insulation Material:	<b>Nil:</b> Class F					
Contact Material:	<b>Nil:</b> AgCdO, <b>T:</b> AgSnO <sub>2</sub> In <sub>2</sub> O <sub>3</sub>					
Spacing:	<b>Nil:</b> UL508, <b>1:</b> UL 508 and UL 873 (Pin #6 Omitted)					
RoHS Compliant:	<b>-X</b>					

Box Quantity: 600; Inner Box 300

**COIL DATA**

Coil Voltage (VAC)		Resistance (Ohms ± 10%)	Must Operate Voltage Max (VAC)	Must Release Voltage Min (VAC)	Rated Current (mA)	Coil Power (VA)
Rated	Max					
12	15.6	27	9.0	3.6	166.6	2.0
24	31.2	120	18.0	7.2	83.3	
110	143	2360	82.5	33.0	18.1	
120	156	3040	90.0	36.0	16.6	
220	286	13490	165.0	86.0	9.1	
240	312	15740	180.0	72.0	8.3	
277	360.1	20300	207.75	83.1	7.2	

**NOTES:**

The use of any coil voltage less than the rated voltage will compromise the operation of the relays. Must Operate Voltage and Most Release Voltages are for test purposes only and are not to be used as design criteria.

**CHARACTERISTICS**

Operate Time	15 ms max.
Release Time	10 ms max.
Insulation Resistance	1,000 MΩ min, at 500 V
Power Consumption	2.0 VA
Dielectric Strength	50 Hz 1,500 V Between Open Contacts
	50 Hz 2,500 V Between Contacts and Coil
Shock Resistance	200 m/s <sup>2</sup>

**CHARACTERISTICS CONT**

Vibration Resistance	10 Hz - 55 Hz Double Amplitude 1.5 mm
Terminal Strength	10N
Solderability	260°C for 5 seconds
Storage Temp. Range	-55°C to 125°C
Operating Temp. Range	-55°C to 100°C
Relative Humidity	85% (at 40°C)
Weight	31 grams
Material Compliant To	EU RoHS V2, EU REACH V3

**MOUNTING TYPE (mm/inches)**

Knock off, on top corner, nib for ventilation after soldering and water wash.

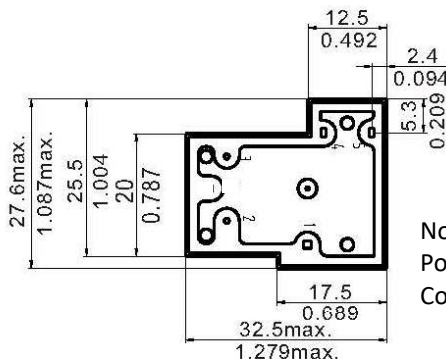

Note:  
Power Pins are 0.8 mm x 1.5 mm  
Coil Pins are Ø0.8 mm

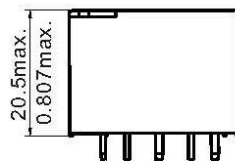
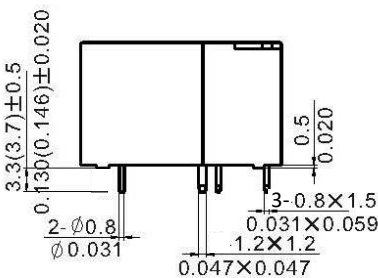
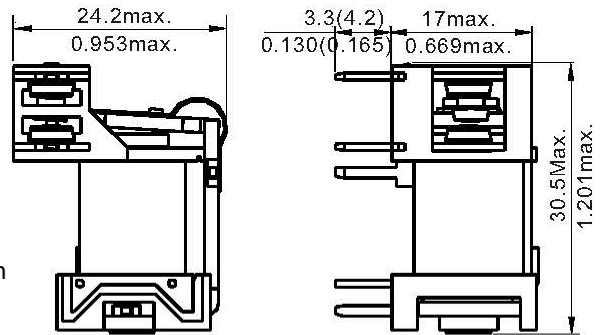

Open type

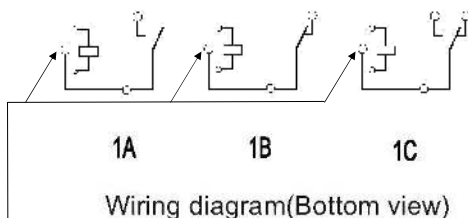

Wiring diagram (Bottom view)

**-1 with Pin 6 Omitted**

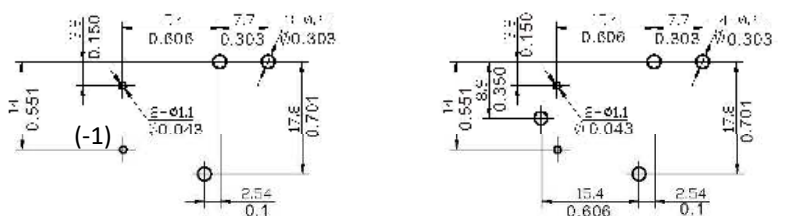

Mounting (Bottom view)

Available with Pin 6 UL508 or Without Pin 6 UL873 (-1)

**PICKER** 20550 Commerce Blvd, Rogers, MN 55374 USA  
Sales: (763) 535-2339

Dimensions are listed for reference purposes only.



# T90 Style Relays

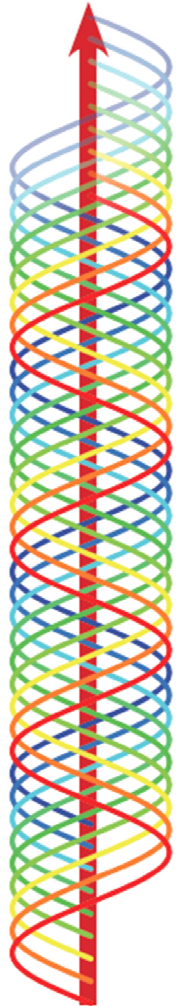
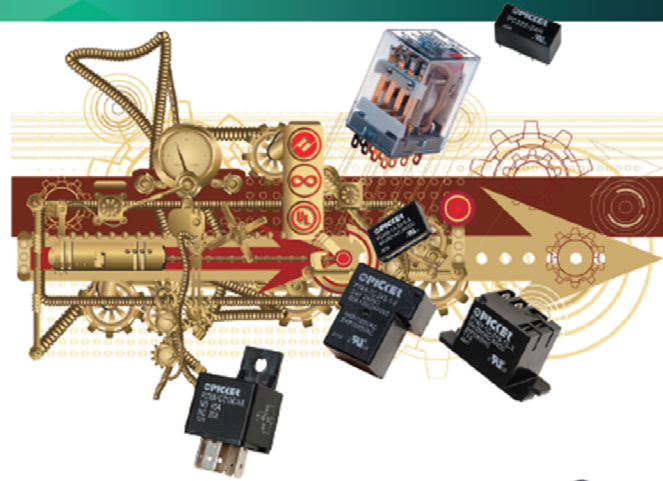

## 50 Amp **P TRE 50/35 Amp 1,500 W, 12,000 VA**

- Larger Contacts than PTRD
- *Braided Copper Wire Added to Dissipate Heat from Contacts to the Coil Frame and PCB Pins*
- 50 Amp 240 VAC 10,000 Cycle UL Resistive Rating
- Class F Material -40° to 125° C Standard

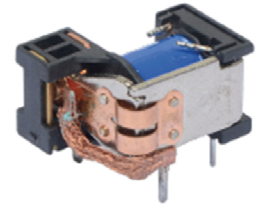

## 45 Amp **P TRV 45 Amp 277 VAC 12,500 VA**

*New*

- >1.8 mm Contact Gap
- 2.25 Watt Coil for Vibration Tolerance
- Class F Material -40° to 85° C Standard
- Designed for PV Inverter & Motor Control Applications



## 40 Amp **P TRD 40/30 Amp 1,200 W, 10,000 VA** **P TRA AC Coil Options from 12 to 277 VAC**

- Larger Contacts than PTRH
- 40 Amp 240 VAC UL Resistive Rating
- 25 Amp 277 VAC 100K Cycles UL Resistive Rating
- Class F Material -40° to 125° C Standard

## 30 Amp **P TRH 30/20 Amp 900 W, 7,500 VA**

- 30 Amp 277 VAC UL General Purpose Rating
- 30 Amp 250 VAC 100K Cycle UL Resistive Rating
- Class B -40° to 100° C Standard, Optional Class F



### Packaging Options (i.e. PTRH-T)



Dust Cover or Sealed with Scratch off Nib



-T (T2 & T3) with PC Pins and Contact QC



-T (T4 & T5) w/QC Tabs & Mounting Ears



-OT (OT2 & OT3) with PC Pins and Contact QC



-OT (OT4 & OT5) w/QC Tabs & Mounting Ears

888-997-3933 • [PickerComponents.com](http://PickerComponents.com)  
[Sales@PickerComponents.com](mailto:Sales@PickerComponents.com)

