



Bridgelux® Gen 7 V8 Array

Product Data Sheet DS104



Introduction

V Series



The V Series™ LED array products deliver high quality light in a compact and cost-effective solid state lighting package. These chip-on-board (CoB) arrays can be efficiently driven at twice the nominal drive current, enabling design flexibility not previously possible. This high flux density light source is designed to support a wide range of high quality, low cost directional luminaires and replacement lamps for commercial and residential applications.

The V8 LED array is available in a variety of CCT and CRI combinations providing substantial design flexibility and energy efficiencies.

Lighting system designs incorporating these LED arrays deliver increased system level efficacy and longer service life. Typical lighting applications include, but are not limited to, replacement lamps, accent, spot, track, down light, wide area, security, and wall pack.

Features

- Efficacy of 167 lm/W typical for 3000K, 80 CRI
- Compact high flux density light source
- Uniform, high quality illumination
- Minimum 70, 80, and 90 CRI options
- Streamlined thermal path
- ENERGY STAR® / ANSI compliant color binning structure with 3 SDCM standard
- More energy efficient than incandescent, halogen and fluorescent lamps
- Low voltage DC operation
- Instant light with unlimited dimming
- V_r bin code backside marking

Benefits

- Enhanced optical control
- Clean white light without pixilation
- High quality, true color reproduction
- Significantly reduced thermal resistance and increased operating temperatures
- Uniform, consistent white light
- Lower operating costs
- Easy to use with daylight and motion detectors to enable increased energy savings
- Reduced maintenance costs
- Environmentally friendly, no disposal issues



Contents

Product Feature Map	2
Product Nomenclature	2
Product Selection Guide	3
Performance at Commonly Used Drive Currents	5
Electrical Characteristics	7
Eye Safety	8
Absolute Maximum Ratings	9
Performance Curves	10
Typical Color Spectrum	12
Typical Radiation Pattern	13
Mechanical Dimensions	14
Color Binning Information	15
Packaging and Labeling	16
Design Resources	18
Precautions	18
Disclaimers	18
About Bridgelux	19

Product Feature Map

Bridgelux arrays are fully engineered devices that provide consistent thermal and optical performance on an engineered mechanical platform. The V Series arrays are the most compact CoB devices across all of

Bridgelux's LED Array products. The arrays incorporate several features to simplify design integration and assembly. Please visit www.bridgelux.com for more information on the V Series family of products.

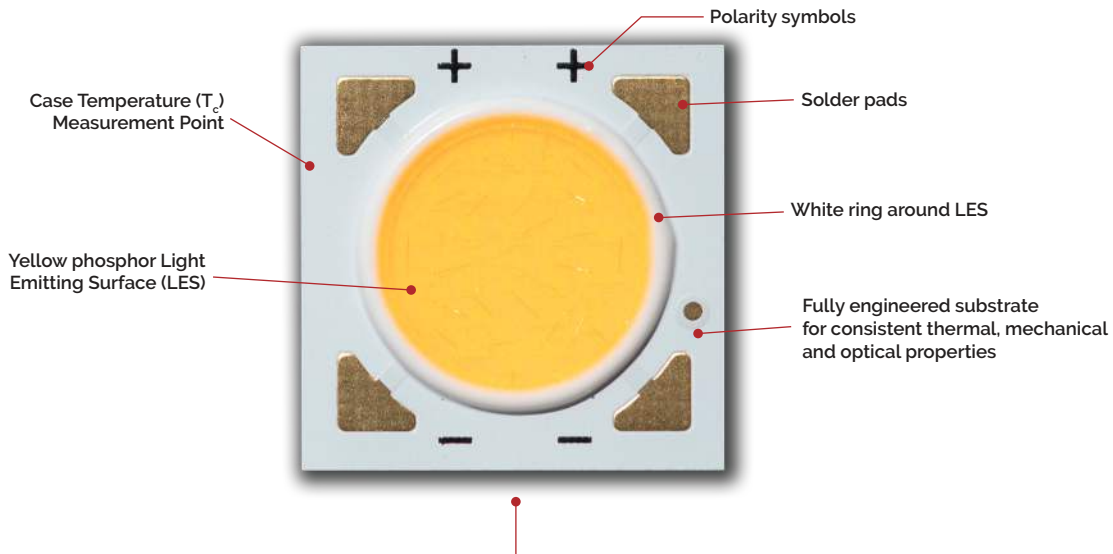

Note: Part number and lot codes are scribed on back of array

Product Nomenclature

The part number designation for Bridgelux V Series LED arrays is explained as follows:

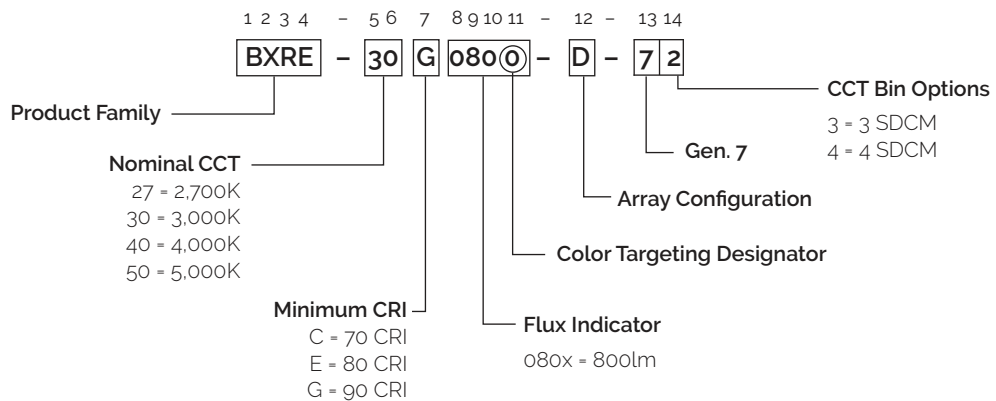

Product Selection Guide

The following product configurations are available:

Table 1: Selection Guide, Pulsed Measurement Data ($T_j = T_c = 25^\circ\text{C}$)

Part Number	Nominal CCT ¹ (K)	CRI ²	Nominal Drive Current ³ (mA)	Typical Pulsed Flux ^{4,5,6} $T_c = 25^\circ\text{C}$ (lm)	Minimum Pulsed Flux ^{6,7} $T_c = 25^\circ\text{C}$ (lm)	Typical V_f (V)	Typical Power (W)	Typical Efficacy (lm/W)
BXRE-27E0800-D-73	2700	80	350	939	826	17.3	6.1	155
BXRE-27E0800-E-73	2700	80	175	941	828	34.7	6.1	155
BXRE-27G08H0-D-73	2700	90	350	805	709	17.3	6.1	133
BXRE-27G08H0-E-73	2700	90	175	808	711	34.7	6.1	133
BXRE-27G0800-D-73	2700	90	350	775	682	17.3	6.1	128
BXRE-27G0800-E-73	2700	90	175	777	684	34.7	6.1	128
BXRE-30C0800-D-74	3000	70	350	1048	922	17.3	6.1	173
BXRE-30C0800-E-74	3000	70	175	1051	924	34.7	6.1	173
BXRE-30E0800-D-73	3000	80	350	999	879	17.3	6.1	165
BXRE-30E0800-E-73	3000	80	175	1002	882	34.7	6.1	165
BXRE-30G08H0-D-73	3000	90	350	848	746	17.3	6.1	140
BXRE-30G08H0-E-73	3000	90	175	850	748	34.7	6.1	140
BXRE-30G0800-D-73	3000	90	350	811	714	17.3	6.1	134
BXRE-30G0800-E-73	3000	90	175	814	716	34.7	6.1	134
BXRE-35E0800-D-73	3500	80	350	1023	900	17.3	6.1	169
BXRE-35E0800-E-73	3500	80	175	1026	903	34.7	6.1	169
BXRE-35G0800-D-73	3500	90	350	842	741	17.3	6.1	139
BXRE-35G0800-E-73	3500	90	175	844	743	34.7	6.1	139
BXRE-40C0800-D-74	4000	70	350	1078	948	17.3	6.1	178
BXRE-40C0800-E-74	4000	70	175	1081	951	34.7	6.1	178
BXRE-40E0800-D-73	4000	80	350	1029	906	17.3	6.1	170
BXRE-40E0800-E-73	4000	80	175	1032	908	34.7	6.1	170
BXRE-40G0800-D-73	4000	90	350	860	757	17.3	6.1	142
BXRE-40G0800-E-73	4000	90	175	862	759	34.7	6.1	142
BXRE-50C0800-D-74	5000	70	350	1078	948	17.3	6.1	178
BXRE-50C0800-E-74	5000	70	175	1081	951	34.7	6.1	178

Notes for Table 1:

- Nominal CCT as defined by ANSI C78.377-2011.
- CRI values are minimums and tested at $T_j = T_c = 25^\circ\text{C}$. Minimum R_g value for 80 CRI products is 0, the minimum R_g values for 90 CRI products is 50.
- Drive current is referred to as nominal drive current.
- Products tested under pulsed condition (10ms pulse width) at nominal test current where T_j (junction temperature) - T_c (case temperature) = 25°C .
- Typical performance values are provided as a reference only and are not a guarantee of performance.
- Bridgelux maintains a $\pm 7\%$ tolerance on flux measurements.
- Minimum flux values at the nominal test current are guaranteed by 100% test.

Product Selection Guide

Table 2: Selection Guide, Stabilized DC Performance ($T_c = 85^\circ\text{C}$)

Part Number	Nominal CCT ¹ (K)	CRI ²	Nominal Drive Current ³ (mA)	Typical DC Flux ^{4,5} $T_c = 85^\circ\text{C}$ (lm)	Minimum DC Flux ⁶ $T_c = 85^\circ\text{C}$ (lm)	Typical V_f (V)	Typical Power (W)	Typical Efficacy (lm/W)
BXRE-27E0800-D-73	2700	80	350	845	743	16.7	5.8	145
BXRE-27E0800-E-73	2700	80	175	847	745	33.4	5.9	145
BXRE-27G08H0-D-73	2700	90	350	725	638	16.7	5.8	124
BXRE-27G08H0-E-73	2700	90	175	727	640	33.4	5.9	124
BXRE-27G0800-D-73	2700	90	350	698	614	16.7	5.8	119
BXRE-27G0800-E-73	2700	90	175	700	616	33.4	5.9	120
BXRE-30C0800-D-74	3000	70	350	943	830	16.7	5.8	161
BXRE-30C0800-E-74	3000	70	175	945	832	33.4	5.9	162
BXRE-30E0800-D-73	3000	80	350	899	791	16.7	5.8	156
BXRE-30E0800-E-73	3000	80	175	902	794	33.4	5.9	154
BXRE-30G08H0-D-73	3000	90	350	763	671	16.7	5.8	131
BXRE-30G08H0-E-73	3000	90	175	765	673	33.4	5.9	131
BXRE-30G0800-D-73	3000	90	350	730	643	16.7	5.8	125
BXRE-30G0800-E-73	3000	90	175	732	644	33.4	5.9	125
BXRE-35E0800-D-73	3500	80	350	921	810	16.7	5.8	160
BXRE-35E0800-E-73	3500	80	175	924	813	33.4	5.9	158
BXRE-35G0800-D-73	3500	90	350	757	667	16.7	5.8	130
BXRE-35G0800-E-73	3500	90	175	760	669	33.4	5.9	130
BXRE-40C0800-D-74	4000	70	350	970	854	16.7	5.8	166
BXRE-40C0800-E-74	4000	70	175	973	856	33.4	5.9	166
BXRE-40E0800-D-73	4000	80	350	926	815	16.7	5.8	158
BXRE-40E0800-E-73	4000	80	175	929	818	33.4	5.9	159
BXRE-40G0800-D-73	4000	90	350	774	681	16.7	5.8	134
BXRE-40G0800-E-73	4000	90	175	776	683	33.4	5.9	133
BXRE-50C0800-D-74	5000	70	350	970	854	16.7	5.8	166
BXRE-50C0800-E-74	5000	70	175	973	856	33.4	5.9	166

Notes for Table 2:

- Nominal CCT as defined by ANSI C78.377-2011.
- CRI values are minimums and tested at $T_j = T_c = 25^\circ\text{C}$. Minimum R_g value for 80 CRI products is 0, the minimum R_g values for 90 CRI products is 50.
- Drive current is referred to as nominal drive current.
- Typical stabilized DC performance values are provided as reference only and are not a guarantee of performance.
- Typical performance is estimated based on operation under DC (direct current) with LED array mounted onto a heat sink with thermal interface material and the case temperature maintained at 85°C . Based on Bridgelux test setup, values may vary depending on the thermal design of the luminaire and/or the exposed environment to which the product is subjected.
- Minimum flux values at elevated temperatures are provided for reference only and are not guaranteed by 100% production testing. Based on Bridgelux test setup, values may vary depending on the thermal design of the luminaire and/or the exposed environment to which the product is subjected.

Performance at Commonly Used Drive Currents

V Series LED arrays are tested to the specifications shown using the nominal drive currents in Table 1. V Series may also be driven at other drive currents dependent on specific application design requirements. The performance at any drive current can be derived from the current vs. voltage characteristics shown in Figures 1 and 2 and the flux vs. current characteristics shown in Figure 3 and 4. The performance at commonly used drive currents is summarized in Table 3.

Table 3: Product Performance at Commonly Used Drive Currents

Part Number	CRI	Drive Current ¹ (mA)	Typical V_f $T_c = 25^\circ\text{C}$ (V)	Typical Power $T_c = 25^\circ\text{C}$ (W)	Typical Flux ² $T_c = 25^\circ\text{C}$ (lm)	Typical DC Flux ³ $T_c = 85^\circ\text{C}$ (lm)	Typical Efficacy $T_c = 25^\circ\text{C}$ (lm/W)
BXRE-27E0800-D-73	80	175	16.6	2.9	484	436	167
		250	16.9	4.2	682	614	161
		350	17.3	6.1	939	845	155
		500	17.8	8.9	1303	1173	146
		700	18.4	12.9	1756	1580	136
BXRE-27E0800-E-73	80	88	33.0	2.9	487	439	168
		125	33.9	4.2	686	617	162
		175	34.7	6.1	941	847	155
		250	35.5	8.9	1306	1175	147
		350	36.8	12.9	1762	1586	137
BXRE-27G08H0-D-73	90	175	16.6	2.9	415	374	143
		250	16.9	4.2	585	527	138
		350	17.3	6.1	805	725	133
		500	17.8	8.9	1118	1006	125
		700	18.4	12.9	1507	1356	117
BXRE-27G08H0-E-73	90	88	33.0	2.9	418	376	144
		125	33.9	4.2	589	530	139
		175	34.7	6.1	808	727	133
		250	35.5	8.9	1120	1008	126
		350	36.8	12.9	1512	1361	117
BXRE-27G0800-D-73	90	175	16.6	2.9	400	360	138
		250	16.9	4.2	563	507	133
		350	17.3	6.1	775	698	128
		500	17.8	8.9	1076	968	121
		700	18.4	12.9	1450	1305	112
BXRE-27G0800-E-73	90	88	33.0	2.9	403	362	139
		125	33.9	4.2	566	510	134
		175	34.7	6.1	777	700	128
		250	35.5	8.9	1078	970	121
		350	36.8	12.9	1455	1310	113
BXRE-30C0801-D-73	70	175	16.6	2.9	540	486	186
		250	16.9	4.2	761	685	180
		350	17.3	6.1	1048	943	173
		500	17.8	8.9	1454	1309	163
		700	18.4	12.9	1960	1764	152

Notes for Table 3:

1. Alternate drive currents in Table 3 are provided for reference only and are not a guarantee of performance.
2. Bridgelux maintains a $\pm 7\%$ tolerance on flux measurements.
3. Typical stabilized DC performance values are provided as reference only and are not a guarantee of performance.

Performance at Commonly Used Drive Currents

Table 3: Product Performance at Commonly Used Drive Currents (continued)

Part Number	CRI	Drive Current ¹ (mA)	Typical V _f T _c = 25°C (V)	Typical Power T _c = 25°C (W)	Typical Flux ² T _c = 25°C (lm)	Typical DC Flux ³ T _c = 85°C (lm)	Typical Efficacy T _c = 25°C (lm/W)
BXRE-30C0801-E-73	70	88	33.0	2.9	544	490	187
		125	33.9	4.2	766	689	181
		175	34.7	6.1	1051	945	173
		250	35.5	8.9	1457	1312	164
		350	36.8	12.9	1967	1770	153
BXRE-30E0800-D-73	80	175	16.6	2.9	515	464	177
		250	16.9	4.2	726	654	172
		350	17.3	6.1	999	899	165
		500	17.8	8.9	1387	1248	156
		700	18.4	12.9	1869	1682	145
BXRE-30E0800-E-73	80	88	33.0	2.9	519	467	179
		125	33.9	4.2	730	657	172
		175	34.7	6.1	1002	902	165
		250	35.5	8.9	1390	1251	157
		350	36.8	12.9	1876	1688	146
BXRE-30G08H0-D-73	90	175	16.6	2.9	437	394	150
		250	16.9	4.2	616	555	146
		350	17.3	6.1	848	763	140
		500	17.8	8.9	1177	1059	132
		700	18.4	12.9	1586	1427	123
BXRE-30G08H0-E-73	90	88	33.0	2.9	440	396	152
		125	33.9	4.2	620	558	146
		175	34.7	6.1	850	765	140
		250	35.5	8.9	1179	1061	133
		350	36.8	12.9	1592	1432	124
BXRE-30G0800-D-73	90	175	16.6	2.9	419	377	144
		250	16.9	4.2	590	531	139
		350	17.3	6.1	811	730	134
		500	17.8	8.9	1126	1014	126
		700	18.4	12.9	1518	1366	118
BXRE-30G0800-E-73	90	88	33.0	2.9	421	379	145
		125	33.9	4.2	593	534	140
		175	34.7	6.1	814	732	134
		250	35.5	8.9	1129	1016	127
		350	36.8	12.9	1523	1371	118
BXRE-35E0800-D-73	80	175	16.6	2.9	528	475	182
		250	16.9	4.2	744	669	176
		350	17.3	6.1	1023	921	169
		500	17.8	8.9	1421	1279	159
		700	18.4	12.9	1914	1723	148

Notes for Table 3:

1. Alternate drive currents in Table 3 are provided for reference only and are not a guarantee of performance.
2. Bridgelux maintains a ± 7% tolerance on flux measurements.
3. Typical stabilized DC performance values are provided as reference only and are not a guarantee of performance.

Performance at Commonly Used Drive Currents

Table 3: Product Performance at Commonly Used Drive Currents (continued)

Part Number	CRI	Drive Current ¹ (mA)	Typical V _f T _c = 25°C (V)	Typical Power T _c = 25°C (W)	Typical Flux ² T _c = 25°C (lm)	Typical DC Flux ³ T _c = 85°C (lm)	Typical Efficacy T _c = 25°C (lm/W)
BXRE-35E0800-E-73	80	88	33.0	2.9	531	478	183
		125	33.9	4.2	748	673	176
		175	34.7	6.1	1026	924	169
		250	35.5	8.9	1424	1281	160
		350	36.8	12.9	1921	1729	149
BXRE-35G0800-D-73	90	175	16.6	2.9	434	391	149
		250	16.9	4.2	612	551	145
		350	17.3	6.1	842	757	139
		500	17.8	8.9	1168	1052	131
		700	18.4	12.9	1574	1417	122
BXRE-35G0800-E-73	90	88	33.0	2.9	437	393	151
		125	33.9	4.2	615	554	145
		175	34.7	6.1	844	760	139
		250	35.5	8.9	1171	1054	132
		350	36.8	12.9	1580	1422	123
BXRE-40C0801-D-73	70	175	16.6	2.9	556	500	191
		250	16.9	4.2	783	705	185
		350	17.3	6.1	1078	970	178
		500	17.8	8.9	1496	1347	168
		700	18.4	12.9	2016	1815	156
BXRE-40C0801-E-73	70	88	33.0	2.9	560	504	193
		125	33.9	4.2	788	709	186
		175	34.7	6.1	1081	973	178
		250	35.5	8.9	1499	1350	169
		350	36.8	12.9	2023	1821	157
BXRE-40E0800-D-73	80	175	16.6	2.9	531	478	183
		250	16.9	4.2	748	673	177
		350	17.3	6.1	1029	926	170
		500	17.8	8.9	1429	1286	160
		700	18.4	12.9	1926	1733	149
BXRE-40E0800-E-73	80	88	33.0	2.9	535	481	184
		125	33.9	4.2	752	677	178
		175	34.7	6.1	1032	929	170
		250	35.5	8.9	1432	1289	161
		350	36.8	12.9	1933	1739	150
BXRE-40G0800-D-73	90	175	16.6	2.9	444	399	153
		250	16.9	4.2	625	563	148
		350	17.3	6.1	860	774	142
		500	17.8	8.9	1194	1074	134
		700	18.4	12.9	1608	1448	125

Notes for Table 3:

1. Alternate drive currents in Table 3 are provided for reference only and are not a guarantee of performance.
2. Bridgelux maintains a ± 7% tolerance on flux measurements.
3. Typical stabilized DC performance values are provided as reference only and are not a guarantee of performance.

Performance at Commonly Used Drive Currents

Table 3: Product Performance at Commonly Used Drive Currents (continued)

Part Number	CRI	Drive Current ¹ (mA)	Typical V_f $T_c = 25^\circ\text{C}$ (V)	Typical Power $T_c = 25^\circ\text{C}$ (W)	Typical Flux ² $T_c = 25^\circ\text{C}$ (lm)	Typical DC Flux ³ $T_c = 85^\circ\text{C}$ (lm)	Typical Efficacy $T_c = 25^\circ\text{C}$ (lm/W)
BXRE-40G0800-E-73	90	88	33.0	2.9	447	402	154
		125	33.9	4.2	628	566	148
		175	34.7	6.1	862	776	142
		250	35.5	8.9	1196	1077	135
		350	36.8	12.9	1614	1453	125
BXRE-50C0800-D-74	70	175	16.6	2.9	556	500	191
		250	16.9	4.2	783	705	185
		350	17.3	6.1	1078	970	178
		500	17.8	8.9	1496	1347	168
		700	18.4	12.9	2016	1815	156
BXRE-50C0800-E-74	70	88	33.0	2.9	560	504	193
		125	33.9	4.2	788	709	186
		175	34.7	6.1	1081	973	178
		250	35.5	8.9	1499	1350	169
		350	36.8	12.9	2023	1821	157

Notes for Table 3:

1. Alternate drive currents in Table 3 are provided for reference only and are not a guarantee of performance.
2. Bridgelux maintains a $\pm 7\%$ tolerance on flux measurements.
3. Typical stabilized DC performance values are provided as reference only and are not a guarantee of performance.

Electrical Characteristics

Table 4: Electrical Characteristics

Part Number	Drive Current (mA)	Forward Voltage Pulsed, $T_c = 25^\circ\text{C}$ (V) ^{1, 2, 3, 8}			Typical Coefficient of Forward Voltage ⁴ $\Delta V_f / \Delta T_c$ (mV/ $^\circ\text{C}$)	Typical Thermal Resistance Junction to Case ^{5,6} R_{j-c} ($^\circ\text{C}/\text{W}$)	Driver Selection Voltages ⁷ (V)	
		Minimum	Typical	Maximum			V_f Min. Hot $T_c = 105^\circ\text{C}$ (V)	V_f Max. Cold $T_c = -40^\circ\text{C}$ (V)
BXRE-xxx080x-D-7x	350	16.0	17.3	18.6	-7.38	0.75	15.4	19.1
	700	17.0	18.5	19.8	-7.38	0.88	16.4	20.3
BXRE-xxx080x-E-7x	175	32.0	34.7	37.2	-14.76	0.75	33.2	37.7
	350	34.1	36.9	39.7	-14.76	0.88	35.3	40.1

Notes for Table 4:

- Parts are tested in pulsed conditions, $T_c = 25^\circ\text{C}$. Pulse width is 10ms.
- Voltage minimum and maximum are provided for reference only and are not a guarantee of performance.
- Bridgelux maintains a tester tolerance of $\pm 0.10\text{V}$ on forward voltage measurements.
- Typical coefficient of forward voltage tolerance is $\pm 0.1\text{mV}$ for nominal current.
- Thermal resistance values are based from test data of a 3000K 80 CRI product.
- Thermal resistance value was calculated using total electrical input power; optical power was not subtracted from input power. The thermal interface material used during testing is not included in the thermal resistance value.
- V_f min hot and max cold values are provided as reference only and are not guaranteed by test. These values are provided to aid in driver design and selection over the operating range of the product.
- This product has been designed and manufactured per IEC 62031:2014. This product has passed dielectric withstand voltage testing at 1160 V. The working voltage designated for the insulation is 80V d.c. The maximum allowable voltage across the array must be determined in the end product application.

Eye Safety

Table 5: Eye Safety Risk Group (RG) Classifications

Part Number	Drive Current ³ (mA)	CCT ^{1,3}		
		2700K/3000K	4000K	5000K ²
BXRE-xxx080x-D-7x	350	RG1	RG1	RG1
	500	RG1	RG1	RG2
	700	RG1	RG1	RG2
BXRE-xxx080x-E-7x	175	RG1	RG1	RG1
	250	RG1	RG1	RG2
	350	RG1	RG1	RG2

Notes for Table 5:

1. Eye safety classification for the use of Bridgelux V Series LED arrays is in accordance with specification IEC/TR 62778: Application of IEC 62471 for the assessment of blue light hazard to light sources and luminaires.
2. For products classified as RG2 at 5000K $E_{thr} = 1315.8$ lx.
3. Please contact your Bridgelux sales representative for E_{thr} values at specific drive currents and CCTs not listed.

Absolute Maximum Ratings

Table 6: Maximum Ratings

Parameter	Maximum Rating	
LED Junction Temperature (T _J)	150°C	
Storage Temperature	-40°C to +105°C	
Operating Case Temperature ¹ (T _C)	105°C	
Soldering Temperature ²	300°C or lower for a maximum of 6 seconds	
	BXRE-xxx080x-D-7x	BXRE-xxx080x-E-7x
Maximum Drive Current ³	700mA	350mA
Maximum Peak Pulsed Drive Current ⁴	1000mA	500mA
Maximum Reverse Voltage ⁵	-35V	-60V

Notes for Table 6:

1. For IEC 62717 requirement, please consult your Bridgelux sales representative.
2. Refer to Bridgelux Application Note AN101: Handling and Assembly of Bridgelux V Series LED Arrays.
3. Arrays may be driven at higher currents however lumen maintenance may be reduced.
4. Bridgelux recommends a maximum duty cycle of 10% and pulse width of 20 ms when operating LED Arrays at maximum peak pulsed current specified. Maximum peak pulsed currents indicate values where LED Arrays can be driven without catastrophic failures.
5. Light emitting diodes are not designed to be driven in reverse voltage and will not produce light under this condition. Maximum rating provided for reference only.

Performance Curves

Figure 1: V8D Drive Current vs. Voltage ($T_j = T_c = 25^\circ\text{C}$)¹

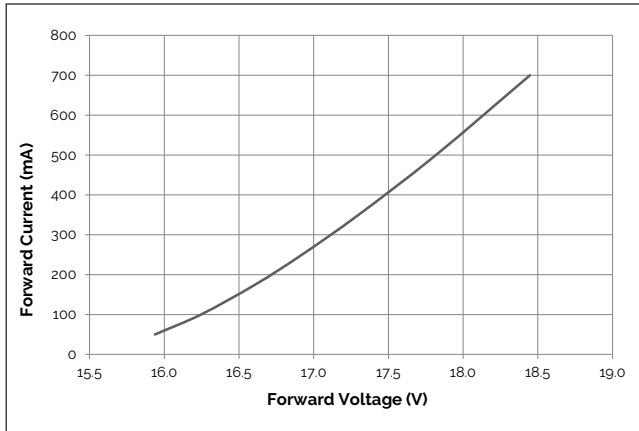

Figure 2: V8E Drive Current vs. Voltage ($T_j = T_c = 25^\circ\text{C}$)¹

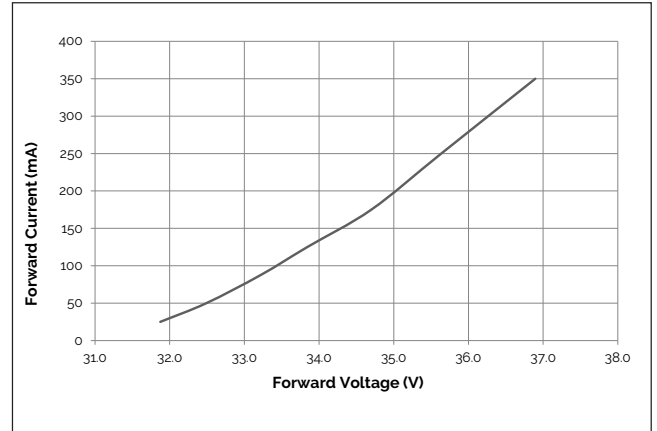

Figure 3: V8D Typical Relative Luminous Flux vs. Drive Current ($T_j = T_c = 25^\circ\text{C}$)¹

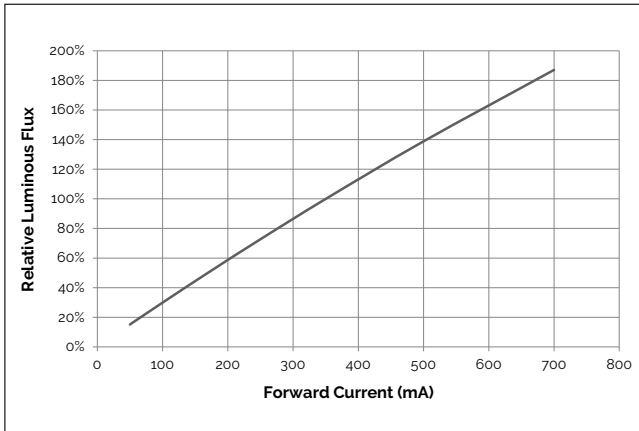
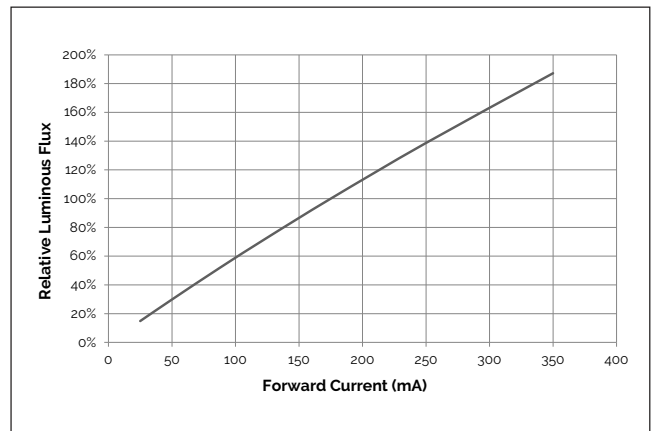

Figure 4: V8E Typical Relative Luminous Flux vs. Drive Current ($T_j = T_c = 25^\circ\text{C}$)¹



Notes for Figures 1 - 4:

1. Bridgelux does not recommend driving high power LEDs at low currents. Doing so may produce unpredictable results. Pulse width modulation (PWM) is recommended for dimming effects.
2. Characteristics shown for 3000K and 90 CRI.

Performance Curves

Figure 5: Typical DC Flux vs. Case Temperature

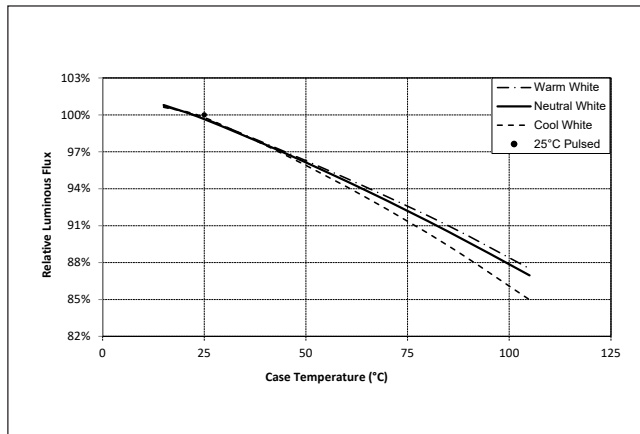

Figure 6: Typical DC ccx Shift vs. Case Temperature

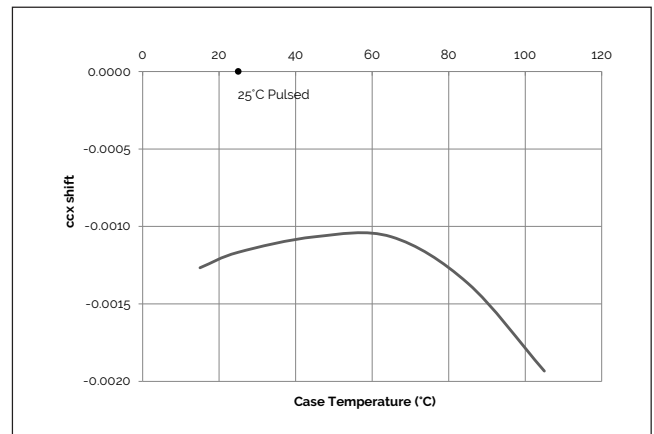
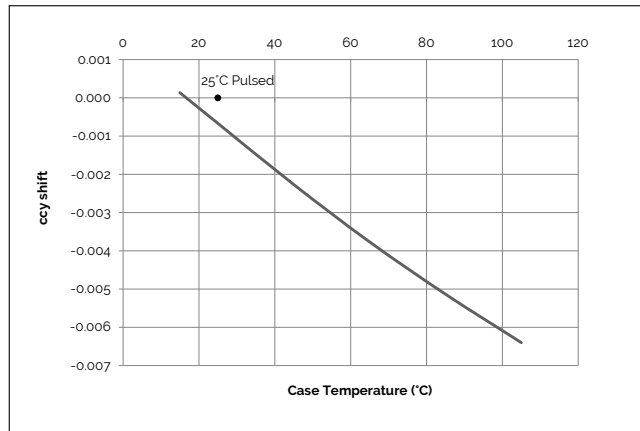
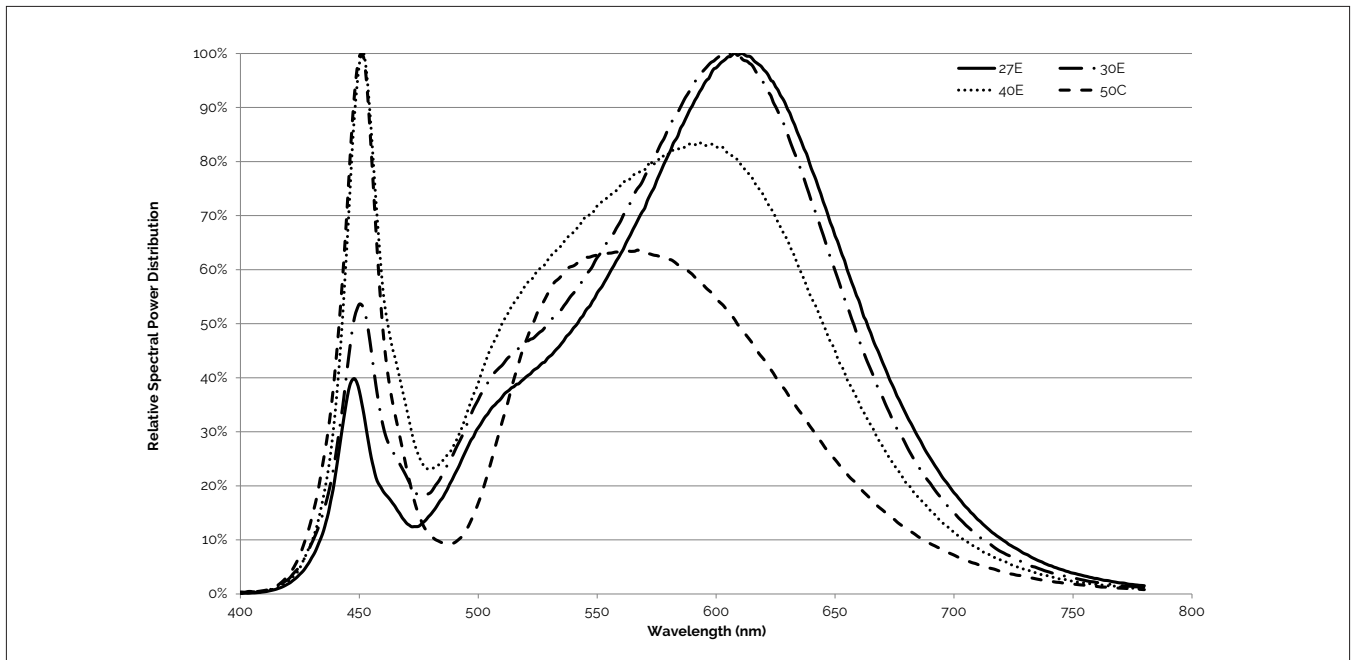

Figure 7: Typical DC ccy Shift vs. Case Temperature



Typical Color Spectrum

Figure 8: Typical Color Spectrum



Note for Figure 8:

1. Color spectra measured at nominal current for $T_j = T_c = 25^\circ\text{C}$.
2. Color spectra shown is 3000K and 80 CRI.
3. Color spectra shown is 4000K and 80 CRI.
4. Color spectra shown is 5000K and 70 CRI.

Typical Radiation Pattern

Figure 9: Typical Spatial Radiation Pattern

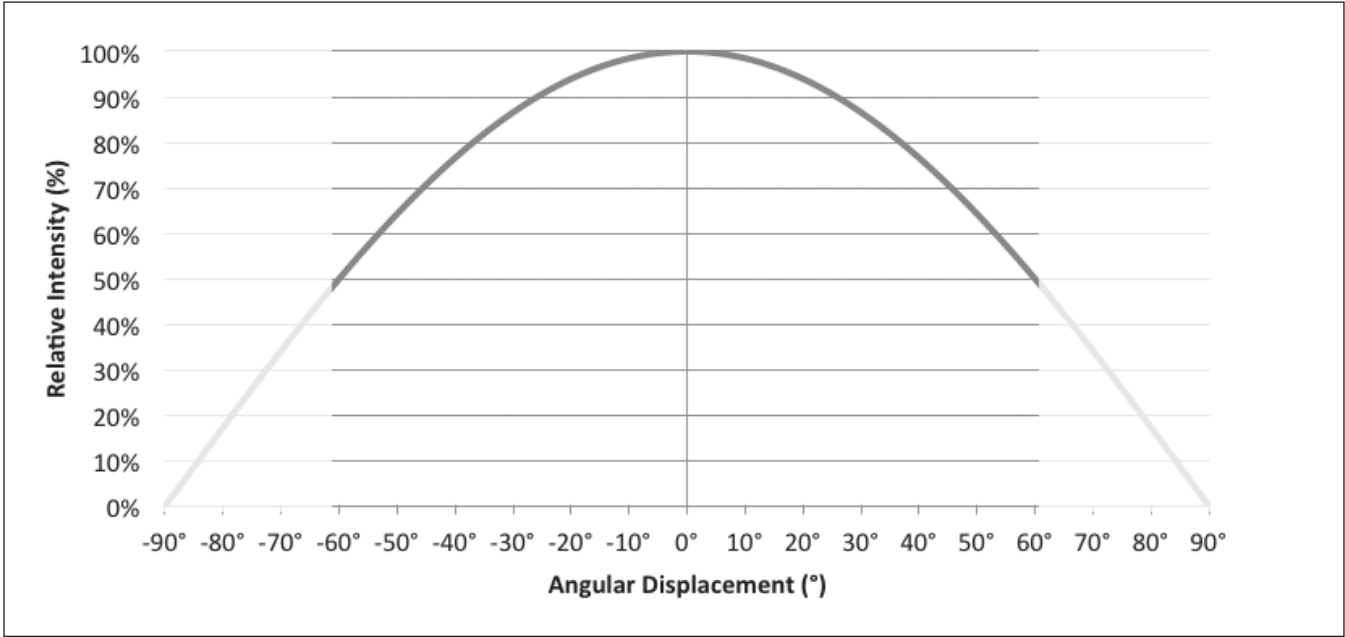

Note for Figure 9:

- 1. Typical viewing angle is 120°.
- 2. The viewing angle is defined as the off axis angle from the centerline where intensity is 1/2 of the peak value.

Figure 10: Typical Polar Radiation Pattern

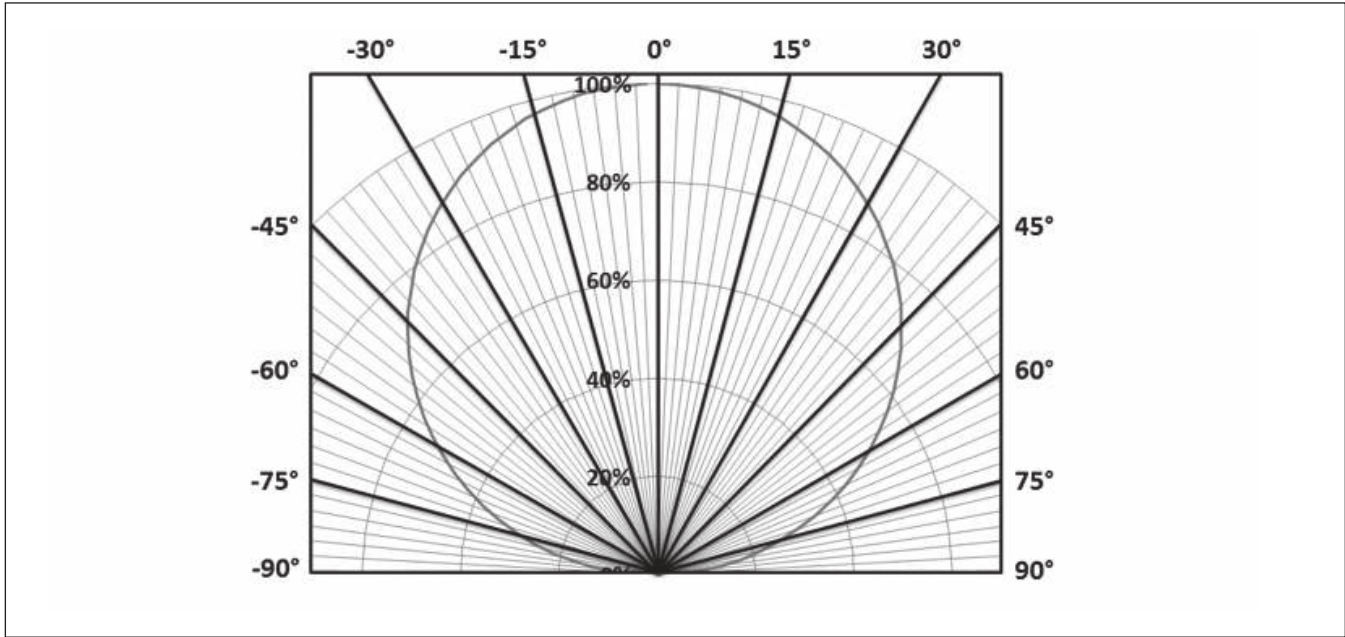

Mechanical Dimensions

Figure 11: V8 LED Array

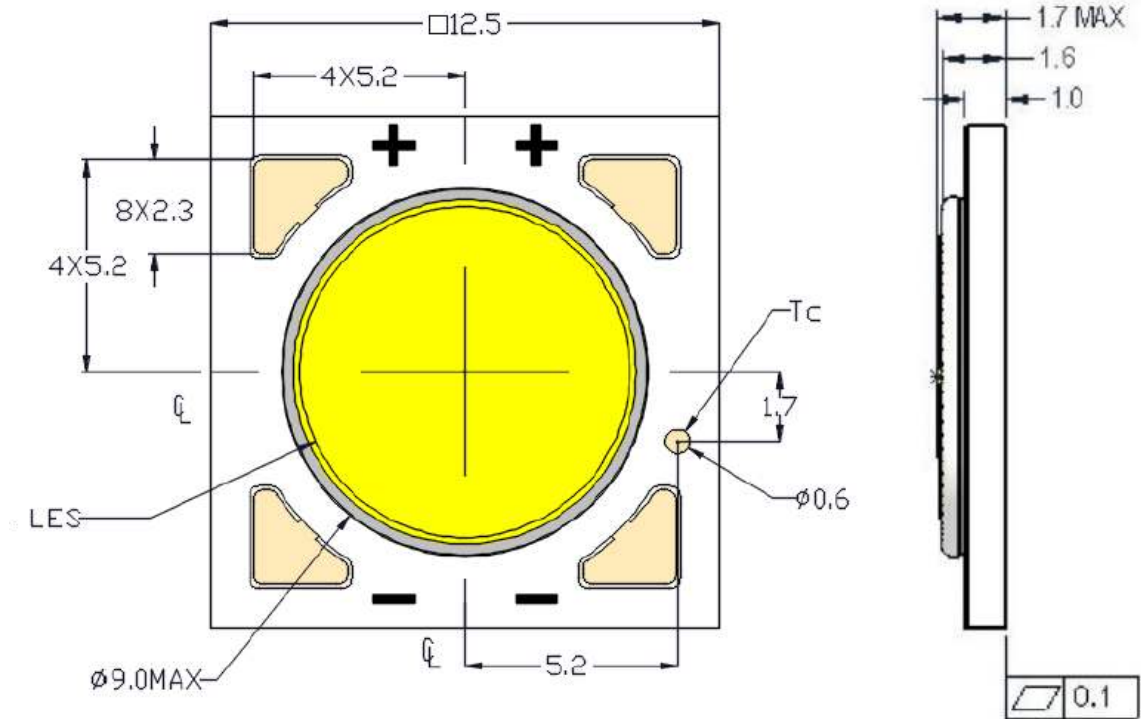

Notes for Figure 11:

1. Drawings are not to scale.
2. Drawing dimensions are in millimeters.
3. Solder pads are labeled "+" and "-" to denote positive and negative polarity, respectively.
4. Unless otherwise specified, tolerances are ± 0.1 mm.
5. Refer to Application Notes AN101 for product handling, mounting and heat sink recommendations.
6. The optical center of the LED Array is nominally defined by the mechanical center of the array to a tolerance of ± 0.2 mm.
7. Bridgelux maintains a flatness of 0.10mm across the mounting surface of the array.

Color Binning Information

Figure 12: Graph of Warm and Neutral White Test Bins in xy Color Space

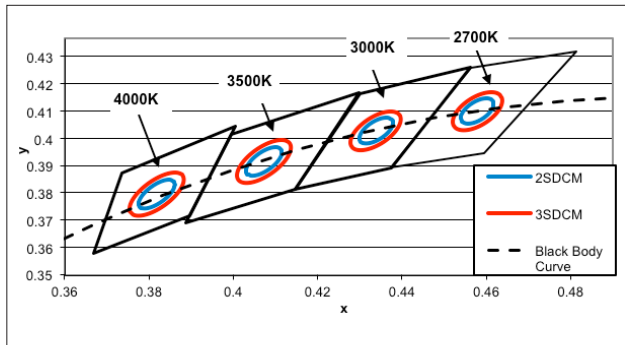

Note: Pulsed Test Conditions, $T_c = 25^\circ\text{C}$

Figure 13: Graph of Cool White Test Bins in xy Color Space

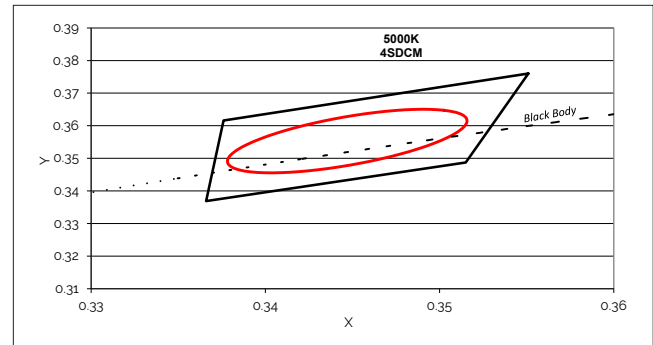

Table 7: Warm and Neutral White xy Bin Coordinates and Associated Typical CCT

Bin Code	2700K	3000K	3500K	4000K
ANSI Bin (for reference only)	(2580K - 2870K)	(2870K - 3220K)	(3220K - 3710K)	(3710K - 4260K)
72 (2 SDCM)	(2674K - 2769K)	(2995K - 3107K)	(3404K - 3548K)	(3895K - 4081K)
73 (3 SDCM)	(2651K - 2794K)	(2968K - 3136K)	(3369K - 3586K)	(3851K - 4130K)
Center Point (x,y)	(0.4578, 0.4101)	(0.4338, 0.403)	(0.4073, 0.3917)	(0.3818, 0.3797)

Table 8: Cool White xy Bin Coordinates and Associated Typical CCT

Bin Code	5000K
ANSI Bin (for reference only)	(4745K - 5311K)
74 (4 SDCM)	(4801K - 5282K)
Center Point (x,y)	(0.3447, 0.3553)

Packaging and Labeling

Figure 14: Drawing for V8 Packaging Tube



Notes for Figure 14:

1. Each tube holds 40 V8 COB arrays.
2. One tube is sealed in an anti-static bag. Four bags are placed in a shipping box. Depending on quantities ordered, a bigger shipping box, containing four boxes may be used to ship products.
3. Each bag and box is to be labeled as shown above.
4. Dimensions for each tube are 8.3mm (W) x 14.3mm (H) x 530mm (L). Dimensions for the anti-static bag are 75 (W) x 615 (L) x 3.1 (T) mm. Dimensions for the shipping box are 58.7 x 13.3 x 7.9 cm

Packaging and Labeling

Figure 15: Gen. 7 Product Labeling

Bridgelux COB arrays have laser markings on the back side of the substrate to help with product identification. In addition to the product identification markings, Bridgelux COB arrays also contain markings for internal Bridgelux manufacturing use only. The image below shows which markings are for customer use and which ones are for Bridgelux internal use only. The Bridgelux internal manufacturing markings are subject to change without notice, however these will not impact the form, function or performance of the COB array.

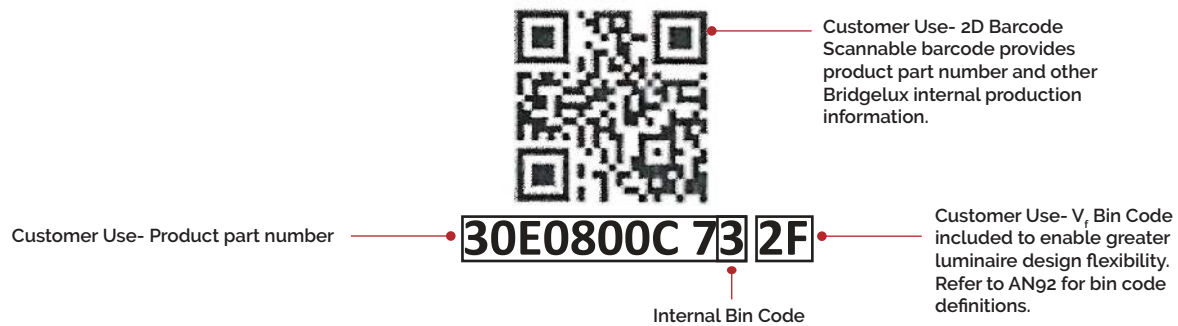

Design Resources

Application Notes

Bridgelux has developed a comprehensive set of application notes and design resources to assist customers in successfully designing with the V Series product family of LED array products. For all available application notes visit www.bridgelux.com.

Optical Source Models

Optical source models and ray set files are available for all Bridgelux products. Please contact your Bridgelux Sales Representative for more information.

3D CAD Models

Three dimensional CAD models depicting the product outline of all Bridgelux V Series LED arrays are available in both IGS and STEP formats. Please contact your Bridgelux sales representative for assistance.

LM80

LM80 testing has been completed and the LM80 report is now available. Please contact your Bridgelux sales representatives for LM-80 report.

Precautions

CAUTION: CHEMICAL EXPOSURE HAZARD

Exposure to some chemicals commonly used in luminaire manufacturing and assembly can cause damage to the LED array. Please consult Bridgelux Application Note AN101 for additional information.

CAUTION: RISK OF BURN

Do not touch the V Series LED array during operation. Allow the array to cool for a sufficient period of time before handling. The V Series LED array may reach elevated temperatures such that could burn skin when touched

CAUTION

CONTACT WITH LIGHT EMITTING SURFACE (LES)

Avoid any contact with the LES. Do not touch the LES of the LED array or apply stress to the LES (yellow phosphor resin area). Contact may cause damage to the LED array.

Optics and reflectors must not be mounted in contact with the LES (yellow phosphor resin area). Use the mechanical features of the LED array housing and/or edges to locate and secure optical devices as needed.

Disclaimers

MINOR PRODUCT CHANGE POLICY

The rigorous qualification testing on products offered by Bridgelux provides performance assurance. Slight cosmetic changes that do not affect form, fit, or function may occur as Bridgelux continues product optimization.

STANDARD TEST CONDITIONS

Unless otherwise stated, array testing is performed at the nominal drive current.

About Bridgelux: Bridging Light and Life™

At Bridgelux, we help companies, industries and people experience the power and possibility of light. Since 2002, we've designed LED solutions that are high performing, energy efficient, cost effective and easy to integrate. Our focus is on light's impact on human behavior, delivering products that create better environments, experiences and returns—both experiential and financial. And our patented technology drives new platforms for commercial and industrial luminaires.

For more information about the company, please visit
bridgelux.com
twitter.com/Bridgelux
facebook.com/Bridgelux
youtube.com/user/Bridgelux
linkedin.com/company/bridgelux-inc-_2
WeChat ID: BridgeluxInChina



46430 Fremont Boulevard
Fremont, CA 94538 USA
Tel (925) 583-8400
www.bridgelux.com

© 2018-2019 Bridgelux, Inc. All rights reserved. Product specifications are subject to change without notice. Bridgelux, the Bridgelux stylized logo design and Vero are registered trademarks, and Decor Series is a trademark of Bridgelux, Inc. All other trademarks are the property of their respective owners.

Bridgelux Gen 7 V8 Array Series Product Data Sheet DS104 Rev. J (09/2020)