

OA180AP IP69K Series

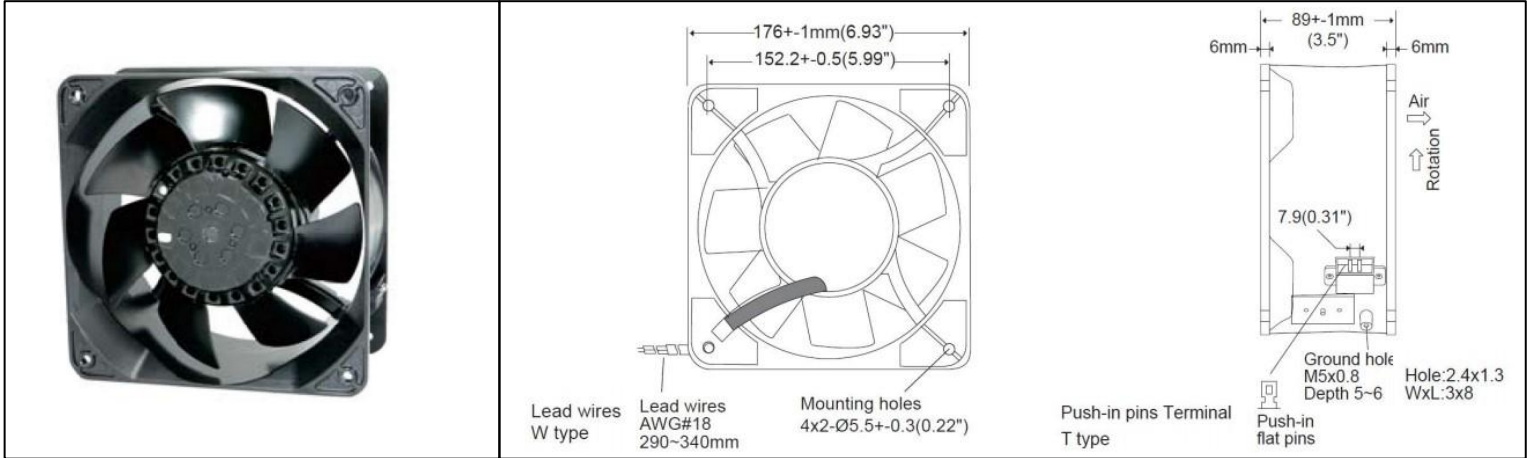

AC Fans - 115, 230V
176mm x 89mm (7.1" x 3.5")



Frame	Die Cast Aluminum, Black Finish	Operating Temperature -30°C ~ +80°C Storage Temperature -40°C ~ +100°C Life Expectancy 50,000 Hours (L10 at 55°C) Weight: 4.08 lbs
Impeller	Steel, All Metal, 7 Blades	
Connection	Lead Wires, 18 AWG, or Terminals	
Motor	AC, Outer Rotor, Capacitor Induction, Single Phase, Thermally Protected, IP69K	
Bearing System	Ball Bearings	
Dielectric Strength	1500VAC/min, <5mA	
Insulation Resistance	≥10MΩ @ 500V DC	

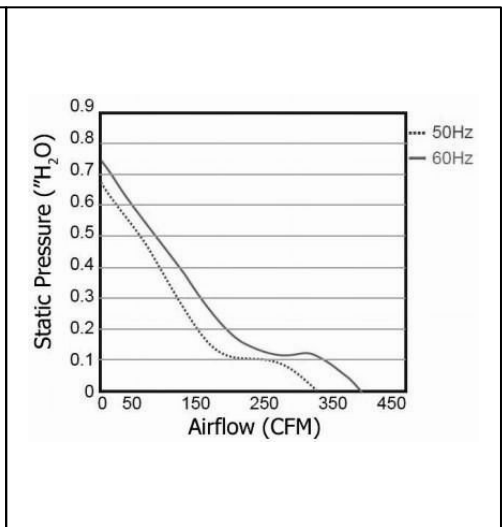

Part Number	Rated Voltage (Volts AC)	Voltage Range (Volts AC)	Input Power (Watts)	Frequency (Hertz)	Rated Speed (RPM)	Max Airflow (CFM)	Noise Level (dBA)	Max Static Pressure ("H ₂ O)
OA180AP-11-1*B1869K	115	100 ~ 130	80	50 / 60	3250	380	63	0.76
OA180AP-22-1*B1869K	230	200 ~ 255	80	50 / 60	3250	380	63	0.76

*Insert "T" for Terminal or "W" for Lead Wire
*60 Hz Values shown in table