

CMC 53W LEFT WIRE OUTPUT

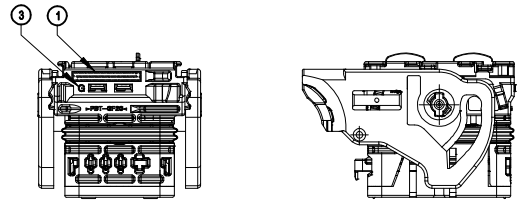

LEFT WIRE OUTPUT (Position shown below)	
MOLEX P/N	COLOR
0643211011	BLACK
0643211018	GREY
0643211019	BROWN
0643211015	GREEN

RIGHT WIRE OUTPUT (Position shown below)	
MOLEX P/N	COLOR
0643212011	BLACK
0643212018	GREY
0643212019	BROWN
0643212015	GREEN

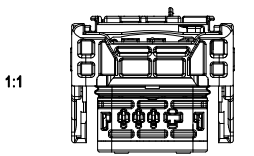
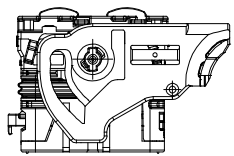
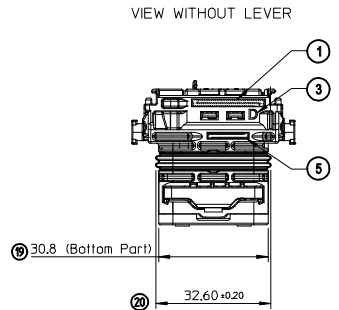
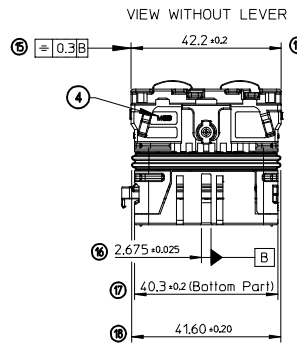
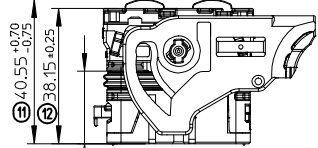
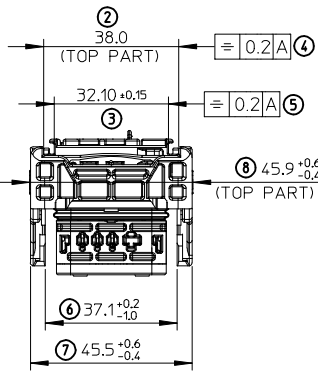
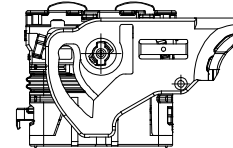
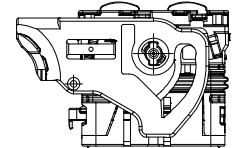

ISOMETRIC VIEWS

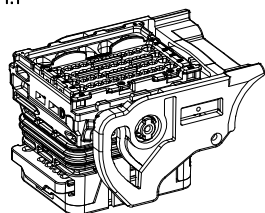
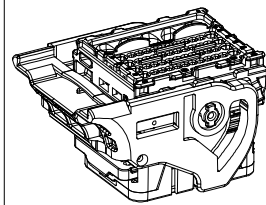

LEFT WIRE OUTPUT

RIGHT WIRE OUTPUT

POS.	QTY	DESCRIPTION	MATERIAL	COLOR
7	1	BACK SEAL "GROMMET"	Silicon	RED
8	1	REAR SEAL COVER	>PBT-GF20<	GREY
5	1	LOCKING LEVER R&L S4	>PBT-GF30<	BLACK
4	1	TPA	>PBT-GF20<	YELLOW
3	1	PERIMETER SEAL SIZE 4	Silicon	RED
2	1	HOUSING TOP PART	>PBT-GF20<	BROWN
1	1	HOUSING BOTTOM PART	>PBT-GF20<	BLACK
				BROWN
				GREY
			GREEN	

MARKINGS:

- ① - Tracking N° for assembled connector. (Year & Day)
- ② - Cavities Identification (N°).
- ③ - Lever sens indicator. Visible letter "D" = RIGHT WIRE OUTPUT. (Lever on the opposite side of the SL Key) Visible letter "G" = LEFT WIRE OUTPUT. (Lever on the side of the SL Key)
- ④ - Supplier logo.
- ⑤ - Molex Area.

NOTES:

- 1- The represented female connector is the "D" version (Way out on the Right), Black coding.
- 2- Application Spec.: AS-64318-002
- 3- Plugs & caps used:  
Cavities 0.6: plug: 0643251010  
Cavities 1.5: plug: 0643251023  
Cavities 2.8: cap: 0643251091
- 4- Weight: 50,8 g
- 5- The assembled female connector matches with the cover CMC 53W (P/N: 0643211011)

\*- Clamping areas on male connector.

MODIFY: COLOR PERIMETER SEAL EC NO: G2014-01Z7 DRAWN: J. JOUAS 2014/01/16 CHKD: CROUCHAN 2014/01/16 APPR: O.PLESSIS 2014/06/17	GENERAL TOLERANCES (UNLESS SPECIFIED)		DIMENSION STYLE <b>MM ONLY</b>	SCALE 1:1	DESIGN UNITS METRIC	FIRST ANGLE PROJECTION	
	4 PLACES ± --- ± --- 3 PLACES ± --- ± --- 2 PLACES ± 0.05 ± --- 1 PLACE ± 0.1 ± --- 0 PLACE ± 0.1 ± ---	m/m INCH	DRAWN BY DATE G. DESBRUERES 2007/09/05	TITLE CMC FEMALE MODULE 53W GENERIC SALES DRAWING	SHEET NO. 1 OF 2		
	ANGULAR ± 2 °		CHECKED BY DATE O.PLESSIS 2007/09/06	<b>molex</b>			
	DRAFT WHERE APPLICABLE MUST REMAIN WITHIN DIMENSIONS		APPROVED BY DATE L. STICKEIR 2007/09/07	MATERIAL NO. SEE CHARTS	DOCUMENT NO. SD-64321-001	INCORPORATED AND SHOULD NOT BE USED WITHOUT WRITTEN PERMISSION	

**CODINGS**

**FEMALE HOUSING RIGHT WIRE OUTPUT**

**MODULE OVERALL DIMENSIONS:**

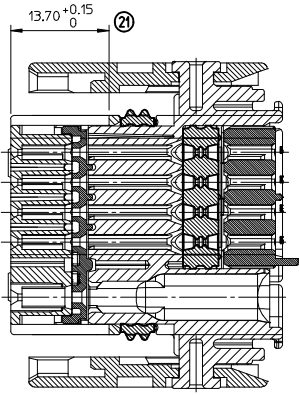

**B - B  
2:1**

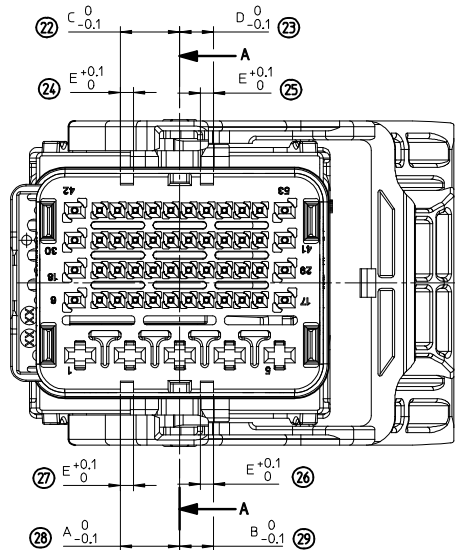

COLOR	CODING	A $\begin{smallmatrix} 0 \\ -0.1 \end{smallmatrix}$	B $\begin{smallmatrix} 0 \\ -0.1 \end{smallmatrix}$	C $\begin{smallmatrix} 0 \\ -0.1 \end{smallmatrix}$	D $\begin{smallmatrix} 0 \\ -0.1 \end{smallmatrix}$	E $\begin{smallmatrix} +0.1 \\ 0 \end{smallmatrix}$
BLACK	1	8.4	4.8	8.4	4.8	1.8
GREY	2	8.4	6.6	6.6	6.6	1.8
BROWN	3	8.4	8.4	4.8	10.2	1.8
GREEN	4	4.8	10.2	8.4	12.0	1.8

**TERMINALS' P/N(S)**

CAVITIES N°	FEMALE TERMINALS (Section mm2)	PLATING	MOLEX P/N	WIRE SEAL	min / MAX WIRE INSULATION DIAMETER
7 to 16 19 to 28 31 to 40 43 to 52	CP 0.6 (0.35mm2)	Tin plated	0643221019		∅1.25 min. / ∅1.40 Max.
		Gold plated	0643221229		
	CP 0.6 (0.5mm2)	Tin plated	0643221039		
		Gold plated	0643221239		
6, 17, 18 29, 30, 41 42, 53	CP 0.6 (0.75mm2)	Tin plated	0643221029		∅1.60 min. / ∅1.90 Max.
		Gold plated	0643221219		
	CP 1.5 (0.5mm2 to 1mm2)	Tin plated	0643231029		
		Gold plated	0643231319		
1 to 5	CP 2.8 (>0.5mm2 to 1mm2)	Tin plated	0643241049	0643251332	∅1.40 min. / ∅2.15 Max.
		Gold plated	0643241149		
	CP 2.8 (>1mm2 to 2mm2)	Tin plated	0643241039	0643251345	∅2.10 min. / ∅2.80 Max.
		Gold plated	0643241139		
	CP 2.8 (>2mm2 to 3mm2)	Tin plated	0643241029	0643251358	∅2.65 min. / ∅3.45 Max.
		Gold plated	0643241129		
	CP 2.8 (>3mm2 to 5mm2)	Tin plated	0643241019	0643251366	∅3.40 min. / ∅4.00 Max.
		Gold plated	0643241119		

**TPA: UNLOCKED POSITION**

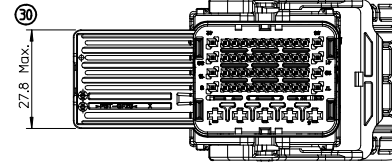

**TPA: DELIVERY POSITION**

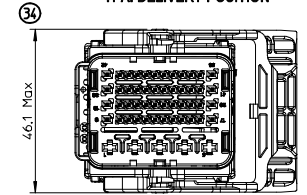

**RIGHT WIRE OUTPUT**

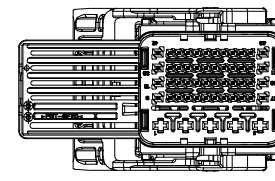
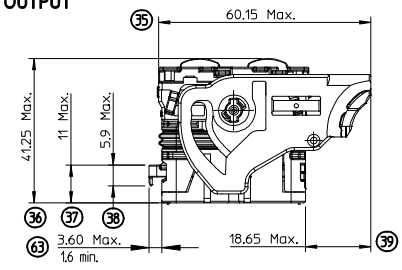
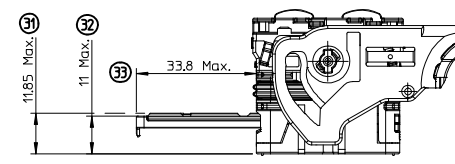

**LEFT WIRE OUTPUT**

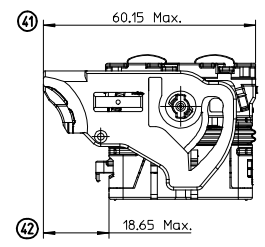
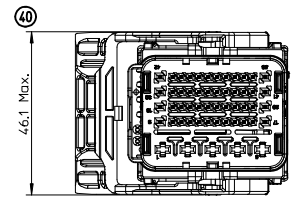
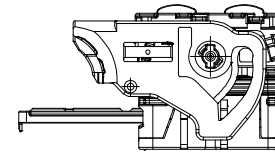

MODIFY COLOR PERMETER SEAL EC NO: G2014-0127 DRW:V.JOUAS 2014/01/16 CHK:G.BOUCHAN 2014/01/16 APPR:O.PLESSIS 2014/06/17	DESCRIPTION	GENERAL TOLERANCES (UNLESS SPECIFIED)		DIMENSION STYLE MM ONLY		SCALE 1.5:1	DESIGN UNITS METRIC	FIRST ANGLE PROJECTION	
		4 PLACES ± --- ± --- 3 PLACES ± --- ± --- 2 PLACES ± 0.05 ± --- 1 PLACE ± 0.1 ± --- 0 PLACE ± 0.1 ± ---	mm INCH	DRAWN BY G. DESBRUERES 2007/09/05	DATE	CHECKED BY O. PLESSIS 2007/09/06	DATE	TITLE CMC FEMALE MODULE 53W GENERIC SALES DRAWING	
APPROVED BY L. STICKEIR 2007/09/07		MATERIAL NO. SEE SHEET 1		DOCUMENT NO. SD-64321-001		SHEET NO. 2 OF 2		INCORPORATED AND SHOULD NOT BE USED WITHOUT WRITTEN PERMISSION	