

Pressure Sensor with Easy-to-Read LED Display



- Pressure status can be checked at a glance from the digital display and bar display.
 - Measurement pressure prevents incorrect outputs due to momentary pressure changes. (*)
 - Perform automatic teaching simply by teaching pressure values for good and bad products.
 - Industry's smallest models at just 28 × 28 × 29 mm.
- * Only in hysteresis mode.



For the most recent information on models that have been certified for safety standards, refer to your OMRON website.



 Be sure to read *Safety Precautions* on page 6.

Ordering Information

Sensors (Refer to Dimensions on page 7.)

Pressure range		ON/OFF output	Linear output	Model	
				NPN output	PNP output
Positive pressure	0 to 100 kPa	Open collector (two independent outputs)	1 to 5 V	E8F2-A01C	E8F2-A01B
	0 to 1 MPa			E8F2-B10C	E8F2-B10B
Negative pressure	0 to -101 kPa			E8F2-AN0C	E8F2-AN0B

Accessories (Order Separately) (Refer to Dimensions on page 7.)

Appearance	Name	Model	Remarks
	Mounting Bracket	E89-F3	Provided with the E8F2.
	Panel-mounting Bracket	E89-F4	Spacer provided.

Ratings and Specifications

Sensor

Item	Model	NPN output PNP output	E8F2-A01C		E8F2-B10C		E8F2-AN0C	
			E8F2-A01B		E8F2-B10B		E8F2-AN0B	
Power supply voltage	12 to 24 VDC±10% with a ripple (p-p) of 10% max.							
Current consumption	70 mA max. *1							
Pressure type	Gauge pressure							
Rated pressure range	0 to 100 kPa		0 to 1 MPa		0 to -101 kPa			
Pressure setting range	0 to 100 kPa		0 to 1 MPa		0 to -101 kPa			
Withstand pressure	400 kPa		1.5 MPa		400 kPa			
Applicable fluid	Non-corrosive gas and non-flammable gas							
Operating mode	Hysteresis mode, window mode, and automatic teaching mode							
Repeat accuracy (ON/OFF output)	±1%FS max.							
Linearity (linear output)	±1%FS max.							
Response time (ON/OFF output)	5 ms max.							
Linear output	1 to 5 V ±5% F.S. with an output impedance of 1 kΩ and a permissible resistive load of 500 kΩ.							
ON/OFF outputs	NO or NC open collector (depending on whether the output configuration is NPN or PNP)							
	Load current	30 mA max.						
	Output applied voltage	30 VDC max.						
	Residual voltage	NPN open collector output: 1 V max. with 30 mA load current PNP open collector output: 2 V max. with 30 mA load current						
Display *2	3.5-digit red LED Green LED bar indicator The orange LED is lit for two independent outputs with output transistor turned ON. Green unit indicator							
Display accuracy	±3%FS±1 digit max.							
Protection circuits	Reverse polarity protection, load short-circuit protection							
Ambient temperature range	Operating: 0 to 55°C Storage: -10 to 60°C (with no icing)							
Ambient humidity range	Operating/Storage: 35% to 85% (with no condensation)							
Temperature influence	±3%FS max.							
Voltage influence	±1.5%FS max.							
Insulation resistance	100 MΩ min. (at 500 VDC) between current-carrying parts and case							
Dielectric strength	1,000 VAC at 1 min							
Vibration resistance	Destruction: 10 to 500 Hz, 1.0-mm double amplitude or 150 m/s ² , three times each for 11 min in the X, Y, and Z directions							
Shock resistance	Destruction: 300 m/s ² 3 times each in the X, Y, and Z directions							
Degree of protection	IP50 (IEC)							
Pressure port	R (PT) 1/8 taper screw and M5 female screw							
Connection method	Pre-wired (standard length: 2 m)							
Cable	Approved by UL							
Weight (packed state)	Approx. 110 g							
Material	Pressure port	Aluminum die-cast						
	Case	Heat-resistive ABS						
Accessories	Mounting Bracket, Instruction manual							

*1. The current consumption is approximately 43 mA in energy-saving mode.

*2. Display Example of Digital Indicator

Model	Setting unit				
	kPa				
	Applied pressure	Digital display			
E8F2-A01C	100	1	0	0	0 ● 0
E8F2-B10C	1000	1	0	0	0
E8F2-AN0C	-101	-1	0	1	0 ● 0

Note: The period (●) in the display indicates the decimal point.
Its position will not change unless the setting unit is changed.

Engineering Data (Reference Value)

Temperature vs. Linear Output Current Fluctuation Temperature vs. Operating Pressure Fluctuation

E8F2-A01 □

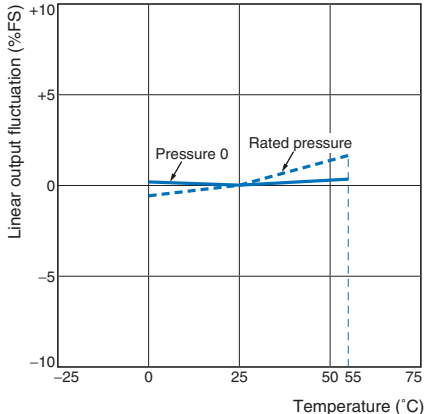

E8F2-A01 □

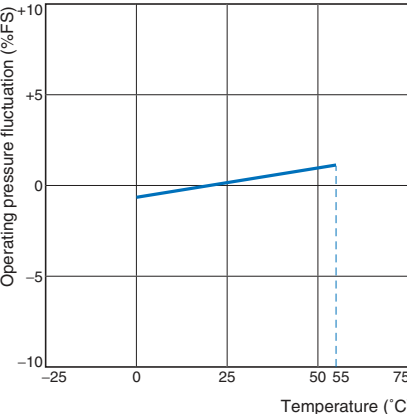

Pressure vs. Linear Output

E8F2-A01 □

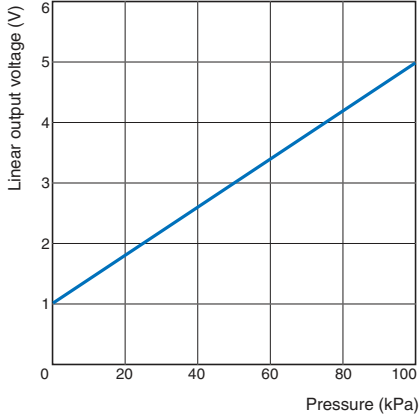

Linearity

E8F2-A01 □

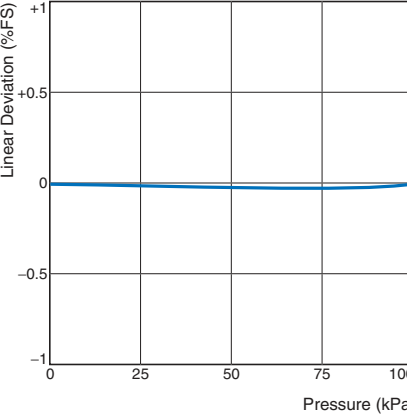

I/O Circuit Diagrams

NPN Output

Operating mode	Model	Timing chart		Output circuit
		Hysteresis mode	Window mode	
NO	E8F2-A01C E8F2-B10C E8F2-AN0C			
NC	E8F2-A01C E8F2-B10C E8F2-AN0C			

PNP Output

Operating mode	Model	Timing chart		Output circuit
		Hysteresis mode	Window mode	
NO	E8F2-A01B E8F2-B10B E8F2-AN0B			
NC	E8F2-A01B E8F2-B10B E8F2-AN0B			

Nomenclature

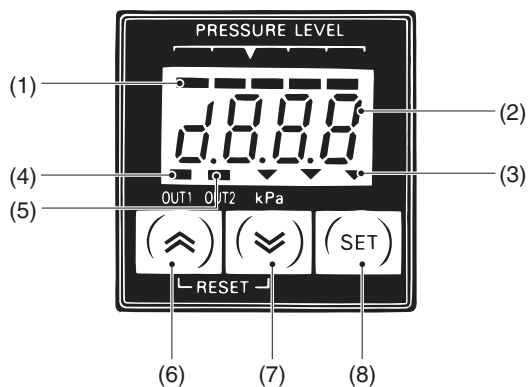

Display Panel

(1) Bar Indicator (Green)

Indicates the degree of measured pressure in relation to the set pressure.

(2) Numeric and Menu Display (Red)

Indicates measurement values and setting menu items.

(3) Unit indicator (Green)

Indicates the unit used for detection. The unit indicated on the indicator is the one currently set.

(4) OUT1 Indicator (Orange)

Lit when OUT1 is turned ON.

(5) OUT2 Indicator (Orange)

Lit when OUT2 is turned ON.

Operation Keys

(6) Up Key, (7) Down Key

- Used to select or change the set items, set contents, and set values in setting mode.
- Press either key to check the ON and OFF points in measurement mode. The values are reset by pressing both keys simultaneously.
- Use together with the SET Key for setting the Sensor to a special setting mode or energy-saving mode.

(8) SET Key

- Used for entering the set contents and set values in setting mode.
- Used for setting the Sensor to basic setting mode or pressure setting mode.

Safety Precautions

Refer to *Warranty and Limitations of Liability*.

WARNING

This product is not designed or rated for ensuring safety of persons either directly or indirectly. Do not use it for such purposes.



Precautions for Correct Use

Do not use this product in atmospheres or environments that exceed product ratings.

● Installation

Do not use the Sensor in an environment subject to corrosive or combustible gas.

● Wiring

If no linear output is used, cut the gray lead wire short and apply insulating tape to the lead wire so that it will not come into contact with any other terminal.

● Mounting

- Do not apply a tensile strength in excess of 50 N to the cables or connectors.
- The pressure port (made of aluminum die-cast) is fixed with tapered R(PT) 1/8 male screws and M5 female screws. When using tapered screws, use tapered Rc(PT) 1/8 female screws.
- Wrap the tapered R(PT) 1/8 male screws with sealing tape to prevent any leakage. Tighten the male screws to a torque of 10 N·m max.
- Tighten M5 female screws to a torque of 2 N·m max.
- Tighten each male screw by using a 12-mm wrench to hold its hexagonal head, not its body.

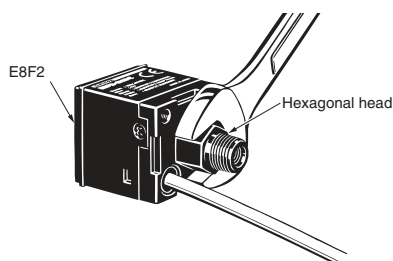

- When attaching the Mounting Bracket to the Sensor, make sure that each M3 screw is tightened to a torque of 0.5 N·m max.

● Adjustments

- Filter the gas with an appropriate air filter so that the applied gas will be free of moisture or oil.
- Be sure to use the Sensor under the rated pressure.
- When setting the set pressure of the ON or OFF point of the output transistor by pressing the mode selection key, use a manometer if precise pressure settings are required. The Sensor has a display error of $\pm 3\%$ FS ± 1 digit at room temperature. Refer to *Display accuracy in Ratings and Specifications*.
- Turning ON the power
The Sensor is ready to operate 0.5 s after it is turned ON. When the load and Sensor are connected to separate power supplies, be sure to turn ON the Sensor first.

● Others

Make sure the Sensor does not get wet.

Dimensions

Sensors

E8F2

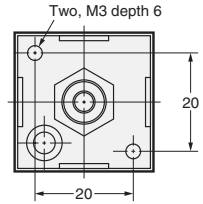
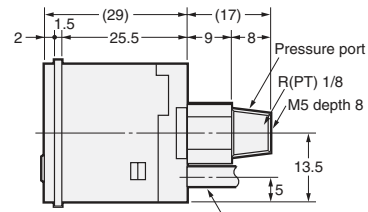
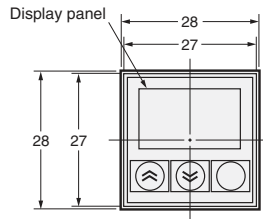
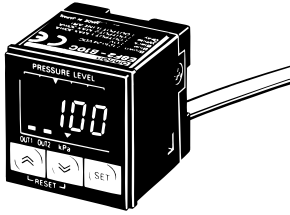

4-dia. vinyl-insulated round cable with 5 conductors
(Conductor cross-section: 0.15 mm², Insulator diameter: 0.9 mm),
Standard length: 2 m

With Mounting Bracket Attached

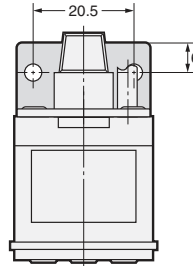

Mounting Hole Dimensions

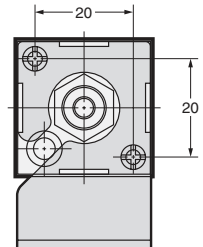
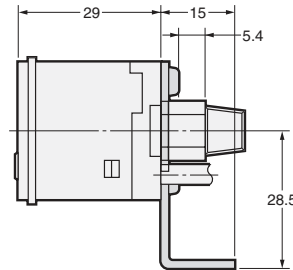
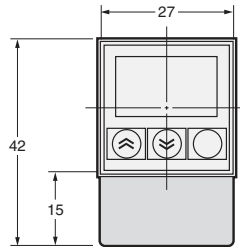
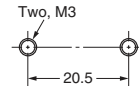

Accessories (Order Separately)

Mounting Bracket

E89-F3

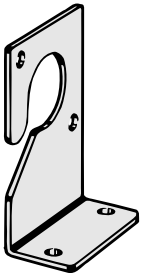

Note: Provided with the E8F2.

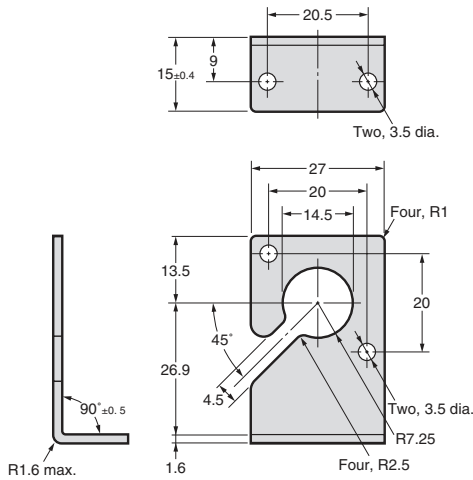

Panel-mounting Bracket

E89-F4

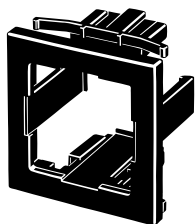

Note: Spacer provided.

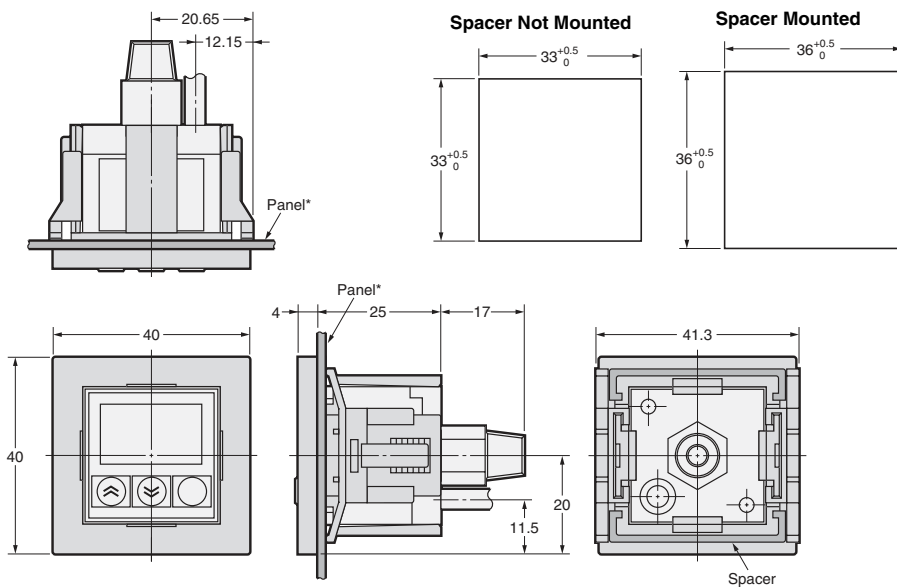

* Applicable panel thickness: 1.2 to 4 mm

Note: The spacer can be removed from the Panel-mounting Bracket. The panel cutout dimensions can be adjusted as shown above by attaching or detaching the spacer.

Terms and Conditions Agreement

Read and understand this catalog.

Please read and understand this catalog before purchasing the products. Please consult your OMRON representative if you have any questions or comments.

Warranties.

(a) Exclusive Warranty. Omron's exclusive warranty is that the Products will be free from defects in materials and workmanship for a period of twelve months from the date of sale by Omron (or such other period expressed in writing by Omron). Omron disclaims all other warranties, express or implied.

(b) Limitations. OMRON MAKES NO WARRANTY OR REPRESENTATION, EXPRESS OR IMPLIED, ABOUT NON-INFRINGEMENT, MERCHANTABILITY OR FITNESS FOR A PARTICULAR PURPOSE OF THE PRODUCTS. BUYER ACKNOWLEDGES THAT IT ALONE HAS DETERMINED THAT THE PRODUCTS WILL SUITABLY MEET THE REQUIREMENTS OF THEIR INTENDED USE.

Omron further disclaims all warranties and responsibility of any type for claims or expenses based on infringement by the Products or otherwise of any intellectual property right. (c) Buyer Remedy. Omron's sole obligation hereunder shall be, at Omron's election, to (i) replace (in the form originally shipped with Buyer responsible for labor charges for removal or replacement thereof) the non-complying Product, (ii) repair the non-complying Product, or (iii) repay or credit Buyer an amount equal to the purchase price of the non-complying Product; provided that in no event shall Omron be responsible for warranty, repair, indemnity or any other claims or expenses regarding the Products unless Omron's analysis confirms that the Products were properly handled, stored, installed and maintained and not subject to contamination, abuse, misuse or inappropriate modification. Return of any Products by Buyer must be approved in writing by Omron before shipment. Omron Companies shall not be liable for the suitability or unsuitability or the results from the use of Products in combination with any electrical or electronic components, circuits, system assemblies or any other materials or substances or environments. Any advice, recommendations or information given orally or in writing, are not to be construed as an amendment or addition to the above warranty.

See <http://www.omron.com/global/> or contact your Omron representative for published information.

Limitation on Liability; Etc.

OMRON COMPANIES SHALL NOT BE LIABLE FOR SPECIAL, INDIRECT, INCIDENTAL, OR CONSEQUENTIAL DAMAGES, LOSS OF PROFITS OR PRODUCTION OR COMMERCIAL LOSS IN ANY WAY CONNECTED WITH THE PRODUCTS, WHETHER SUCH CLAIM IS BASED IN CONTRACT, WARRANTY, NEGLIGENCE OR STRICT LIABILITY.

Further, in no event shall liability of Omron Companies exceed the individual price of the Product on which liability is asserted.

Suitability of Use.

Omron Companies shall not be responsible for conformity with any standards, codes or regulations which apply to the combination of the Product in the Buyer's application or use of the Product. At Buyer's request, Omron will provide applicable third party certification documents identifying ratings and limitations of use which apply to the Product. This information by itself is not sufficient for a complete determination of the suitability of the Product in combination with the end product, machine, system, or other application or use. Buyer shall be solely responsible for determining appropriateness of the particular Product with respect to Buyer's application, product or system. Buyer shall take application responsibility in all cases.

NEVER USE THE PRODUCT FOR AN APPLICATION INVOLVING SERIOUS RISK TO LIFE OR PROPERTY OR IN LARGE QUANTITIES WITHOUT ENSURING THAT THE SYSTEM AS A WHOLE HAS BEEN DESIGNED TO ADDRESS THE RISKS, AND THAT THE OMRON PRODUCT(S) IS PROPERLY RATED AND INSTALLED FOR THE INTENDED USE WITHIN THE OVERALL EQUIPMENT OR SYSTEM.

Programmable Products.

Omron Companies shall not be responsible for the user's programming of a programmable Product, or any consequence thereof.

Performance Data.

Data presented in Omron Company websites, catalogs and other materials is provided as a guide for the user in determining suitability and does not constitute a warranty. It may represent the result of Omron's test conditions, and the user must correlate it to actual application requirements. Actual performance is subject to the Omron's Warranty and Limitations of Liability.

Change in Specifications.

Product specifications and accessories may be changed at any time based on improvements and other reasons. It is our practice to change part numbers when published ratings or features are changed, or when significant construction changes are made. However, some specifications of the Product may be changed without any notice. When in doubt, special part numbers may be assigned to fix or establish key specifications for your application. Please consult with your Omron's representative at any time to confirm actual specifications of purchased Product.

Errors and Omissions.

Information presented by Omron Companies has been checked and is believed to be accurate; however, no responsibility is assumed for clerical, typographical or proofreading errors or omissions.

2015.8

In the interest of product improvement, specifications are subject to change without notice.

OMRON Corporation
Industrial Automation Company

<http://www.ia.omron.com/>

(c)Copyright OMRON Corporation 2015 All Right Reserved.