

Preliminary Technical Data

ADSP-21060C/ADSP-21060LC

SUMMARY

High Performance Signal Processor for Communications, Graphics, and Imaging Applications
Super Harvard Architecture

Four Independent Buses for Dual Data Fetch, Instruction Fetch, and Nonintrusive I/O

32-Bit IEEE Floating-Point Computation Units—Multiplier, ALU, and Shifter

Dual-Ported On-Chip SRAM and Integrated I/O Peripherals—A Complete System-On-A-Chip

Integrated Multiprocessing Features

Industrial Temperature Grade Hermetic Ceramic QFP Package

KEY FEATURES

40 MIPS, 25 ns Instruction Rate, Single-Cycle Instruction Execution

120 MFLOPS Peak, 80 MFLOPS Sustained Performance

Dual Data Address Generators with Modulo and Bit-Reverse Addressing

Efficient Program Sequencing with Zero-Overhead

Looping: Single-Cycle Loop Setup

IEEE JTAG Standard 1149.1 Test Access Port and

On-Chip Emulation

240-Lead Thermally Enhanced PQFP Package

32-Bit Single-Precision and 40-Bit Extended-Precision

IEEE Floating-Point Data Formats or 32-Bit Fixed-Point Data Format

Parallel Computations

Single-Cycle Multiply and ALU Operations in Parallel

with Dual Memory Read/Writes and Instruction Fetch

Multiply with Add and Subtract for Accelerated FFT

Butterfly Computation

4 Mbit On-Chip SRAM

Dual-Ported for Independent Access by Core Processor and DMA

Off-Chip Memory Interfacing

4 Gigawords Addressable

Programmable Wait State Generation, Page-Mode DRAM Support

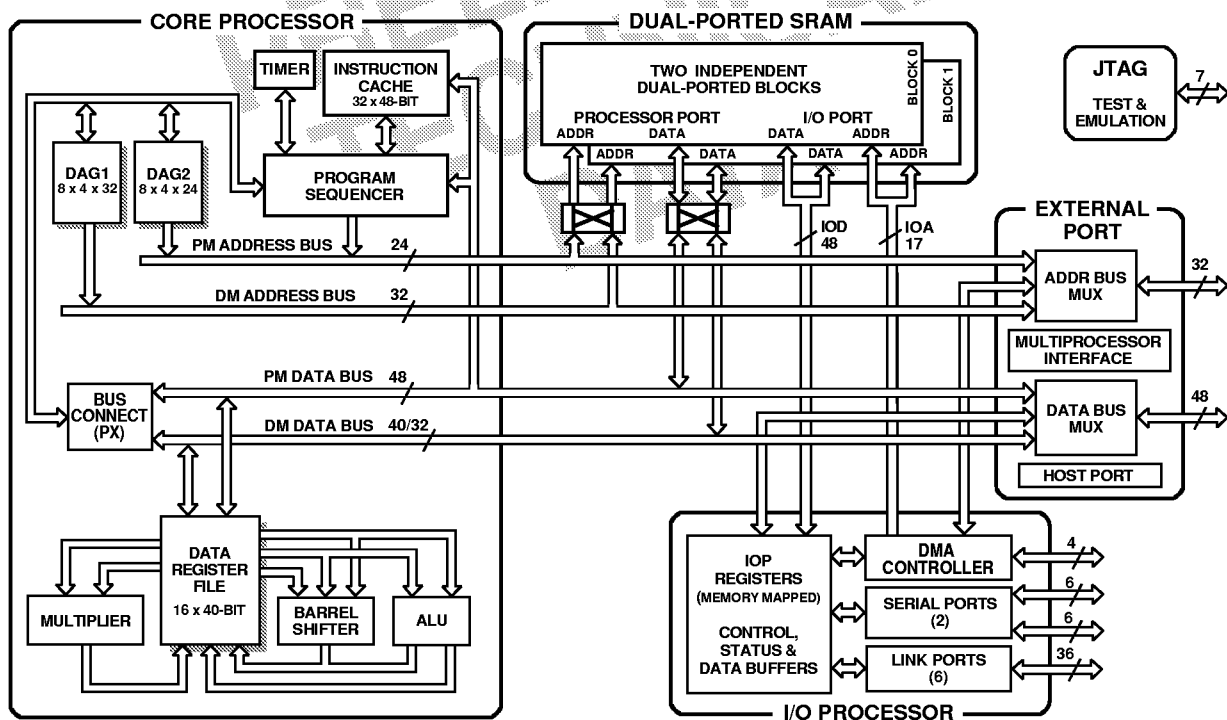

Figure 1. Block Diagram

SHARC is a registered trademark of Analog Devices, Inc.

REV. PrA

Information furnished by Analog Devices is believed to be accurate and reliable. However, no responsibility is assumed by Analog Devices for its use, nor for any infringements of patents or other rights of third parties which may result from its use. No license is granted by implication or otherwise under any patent or patent rights of Analog Devices.

One Technology Way, P.O. Box 9106, Norwood, MA 02062-9106, U.S.A.
Tel: 781/329-4700 World Wide Web Site: <http://www.analog.com>
Fax: 781/326-8703 © Analog Devices, Inc., 1998

ADSP-21060C/ADSP-21060LC

DMA Controller

10 DMA Channels for Transfers Between ADSP-2106x Internal Memory and External Memory, External Peripherals, Host Processor, Serial Ports, or Link Ports

Background DMA Transfers at 40 MHz, in Parallel with Full-Speed Processor Execution

Host Processor Interface to 16- and 32-Bit Microprocessors
Host Can Directly Read/Write ADSP-2106x Internal Memory

Multiprocessing

Glueless Connection for Scalable DSP Multiprocessing Architecture

Distributed On-Chip Bus Arbitration for Parallel Bus Connect of Up to Six ADSP-2106xs Plus Host Six Link Ports for Point-to-Point Connectivity and Array Multiprocessing

240 Mbytes/s Transfer Rate Over Parallel Bus

240 Mbytes/s Transfer Rate Over Link Ports

Serial Ports

Two 40 Mbit/s Synchronous Serial Ports with Companding Hardware
Independent Transmit and Receive Functions

TABLE OF CONTENTS

GENERAL DESCRIPTION	3
ADSP-21000 FAMILY CORE ARCHITECTURE	4
ADSP-21060C/ADSP-21060LC FEATURES	4
DEVELOPMENT TOOLS	7
PIN FUNCTION DESCRIPTIONS	8
TARGET BOARD CONNECTOR FOR EZ-ICE®	
PROBE	11
RECOMMENDED OPERATING CONDITIONS (5V)	13
ELECTRICAL CHARACTERISTICS (5V)	13
POWER DISSIPATION ADSP-21060 (5V)	14
RECOMMENDED OPERATING CONDITIONS (3.3V)	15
ELECTRICAL CHARACTERISTICS (3.3V)	15
POWER DISSIPATION ADSP-21060L (3.3V)	16
ABSOLUTE MAXIMUM RATINGS	17
TIMING SPECIFICATIONS	17
Memory Read—Bus Master	20
Memory Write—Bus Master	21
Synchronous Read/Write—Bus Master	22
Synchronous Read/Write—Bus Slave	24
Multiprocessor Bus Request and Host Bus Request	25
Asynchronous Read/Write—Host to ADSP-2106x	27
Three-State Timing—Bus Master, Bus Slave, HBR, SBTS	29
DMA Handshake	30
Link Ports: 1 × CLK Speed Operation	32
Link Ports: 2 × CLK Speed Operation	33
Serial Ports	35
JTAG Test Access Port and Emulation	38
OUTPUT DRIVE CURRENTS	39
POWER DISSIPATION	39
TEST CONDITIONS	39
ENVIRONMENTAL CONDITIONS	42
240-LEAD METRIC PQFP PIN CONFIGURATIONS	43
OUTLINE DIMENSIONS	44
ORDERING GUIDE	44

FIGURES

Figure 1. ADSP-21060C/ADSP-21060LC Block Diagram	1
Figure 2. ADSP-2106x System	4
Figure 3. Shared Memory Multiprocessing System	6
Figure 4. ADSP-21060C/ADSP-21060LC Memory Map	7
Figure 5. Target Board Connector For ADSP-2106x EZ-ICE Emulator (Jumper in Place)	11
Figure 6. JTAG Scan Path Connections for Multiple ADSP-2106x Systems	11

Figure 7. JTAG Clocktree for Multiple ADSP-2106x Systems	12
Figure 8. Clock Input	18
Figure 9. Reset	18
Figure 10. Interrupts	18
Figure 11. Timer	19
Figure 12. Flags	19
Figure 13. Memory Read—Bus Master	20
Figure 14. Memory Write—Bus Master	21
Figure 15. Synchronous Read/Write—Bus Master	23
Figure 16. Synchronous Read/Write—Bus Slave	24
Figure 17. Multiprocessor Bus Request and Host Bus Request	26
Figure 18a. Synchronous READY Timing	27
Figure 18b. Asynchronous Read/Write—Host to ADSP-2106x	28
Figure 19a. Three-State Timing (Bus Transition Cycle, SBTS Assertion)	29
Figure 19b. Three-State Timing (Host Transition Cycle)	29
Figure 20. DMA Handshake Timing	31
Figure 21. Link Ports	34
Figure 22. Serial Ports	36
Figure 23. External Late Frame Sync	37
Figure 24. IEEE 1149.1 JTAG Test Access Port	38
Figure 25. Output Enable/Disable	40
Figure 26. Equivalent Device Loading for AC Measurements (Includes All Fixtures)	40
Figure 27. Voltage Reference Levels for AC Measurements (Except Output Enable/Disable)	40
Figure 28. ADSP-2106x Typical Drive Currents (V _{DD} = 5V)	41
Figure 29. Typical Output Rise Time (10%–90% V _{DD}) vs. Load Capacitance (V _{DD} = 5V)	41
Figure 30. Typical Output Rise Time (0.8V–2.0V) vs. Load Capacitance (V _{DD} = 5V)	41
Figure 31. Typical Output Delay or Hold vs. Load Capacitance (at Maximum Case Temperature) (V _{DD} = 5V)	41
Figure 32. ADSP-2106x Typical Drive Currents (V _{DD} = 3.3V)	41
Figure 33. Typical Output Rise Time (10%–90% V _{DD}) vs. Load Capacitance (V _{DD} = 3.3V)	41
Figure 34. Typical Output Rise Time (0.8V–2.0V) vs. Load Capacitance (V _{DD} = 3.3V)	42
Figure 35. Typical Output Delay or Hold vs. Load Capacitance (at Maximum Case Temperature) (V _{DD} = 3.3V)	42

SHARC

GENERAL DESCRIPTION

The ADSP-2106x SHARC – Super Harvard Architecture Computer – is a signal processing microcomputer that offers new capabilities and levels of performance. The ADSP-2106x SHARC s are 32-bit processors optimized for high performance DSP applications. The ADSP-2106x builds on the ADSP-21000 DSP core to form a complete system-on-a-chip, adding a dual-ported on-chip SRAM and integrated I/O peripherals supported by a dedicated I/O bus.

Fabricated in a high speed, low power CMOS process, the ADSP-2106x has a 25 ns instruction cycle time and operates at 40 MIPS. With its on-chip instruction cache, the processor can execute every instruction in a single cycle. Table I shows performance benchmarks for the ADSP-2106x.

The ADSP-2106x SHARC represents a new standard of integration for signal computers, combining a high performance floating-point DSP core with integrated, on-chip system features including a 4M bit SRAM memory host processor interface, DMA controller, serial ports, and link port and parallel bus connectivity for glueless DSP multiprocessing.

Figure 1 shows a block diagram of the ADSP-21060C / ADSP-21060LC, illustrating the following architectural features:

- Computation Units (ALU, Multiplier and Shifter) with a Shared Data Register File
- Data Address Generators (DAG 1, DAG 2)
- Program Sequencer with Instruction Cache
- Interval Timer
- On-Chip SRAM
- External Port for Interfacing to Off-Chip Memory and Peripherals
- Host Port and Multiprocessor Interface
- DMA Controller
- Serial Ports and Link Ports
- JTAG Test Access Port

Figure 2 shows a typical single-processor system. A multiprocessing system is shown in Figure 3.

Table I. ADSP-21060C/ADSP-21060LC Benchmarks (@ 40 MHz)

1024-Point Complex FFT (Radix 4, with Digit Reverse)	0.46 ms	18,221 cycles
FIR Filter (per Tap)	25 ns	1 cycle
IIR Filter (per BiQuad)	100 ns	4 cycles
Divide (y/x)	150 ns	6 cycles
Inverse Square Root ($1/\sqrt{x}$)	225 ns	9 cycles
DMA Transfer Rate	240 M bytes/s	

ADSP-21060C/ADSP-21060LC

ADSP-21000 FAMILY CORE ARCHITECTURE

The ADSP-2106x includes the following architectural features of the ADSP-21000 family core. The ADSP-21060C is code- and function-compatible with the ADSP-21061 and ADSP-21062.

Independent, Parallel Computation Units

The arithmetic/logic unit (ALU), multiplier and shifter all perform single-cycle instructions. The three units are arranged in parallel, maximizing computational throughput. Single multi-function instructions execute parallel ALU and multiplier operations. These computation units support IEEE 32-bit single-precision floating-point, extended precision 40-bit floating-point, and 32-bit fixed-point data formats.

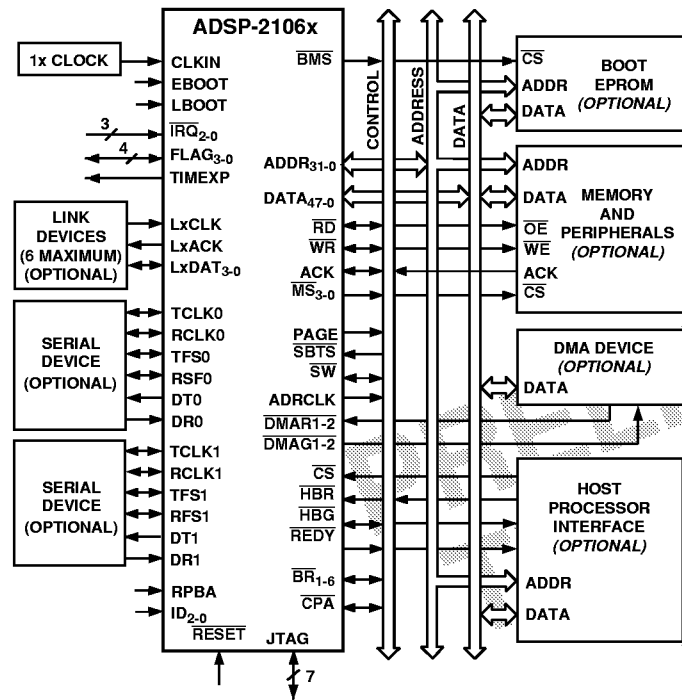

Figure 2. ADSP-2106x System

Data Register File

A general-purpose data register file is used for transferring data between the computation units and the data buses, and for storing intermediate results. This 10-port, 32-register (16 primary, 16 secondary) register file, combined with the ADSP-21000 Harvard architecture, allows unconstrained data flow between computation units and internal memory.

Single-Cycle Fetch of Instruction and Two Operands

The ADSP-2106x features an enhanced Harvard architecture in which the data memory (DM) bus transfers data and the program memory (PM) bus transfers both instructions and data (see Figure 1). With its separate program and data memory buses and on-chip instruction cache, the processor can simultaneously fetch two operands and an instruction (from the cache), all in a single cycle.

Instruction Cache

The ADSP-2106x includes an on-chip instruction cache that enables three-bus operation for fetching an instruction and two data values. The cache is selective—only the instructions whose fetches conflict with PM bus data accesses are cached. This allows full-speed execution of core, looped operations such as digital filter multiply-accumulates and FFT butterfly processing.

Data Address Generators with Hardware Circular Buffers

The ADSP-2106x's two data address generators (DAGs) implement circular data buffers in hardware. Circular buffers allow efficient programming of delay lines and other data structures required in digital signal processing, and are commonly used in digital filters and Fourier transforms. The two DAGs of the ADSP-2106x contain sufficient registers to allow the creation of up to 32 circular buffers (16 primary register sets, 16 secondary). The DAGs automatically handle address pointer wrap-around, reducing overhead, increasing performance, and simplifying implementation. Circular buffers can start and end at any memory location.

Flexible Instruction Set

The 48-bit instruction word accommodates a variety of parallel operations, for concise programming. For example, the ADSP-2106x can conditionally execute a multiply, an add, a subtract and a branch, all in a single instruction.

ADSP-21060C/ADSP-21060LC FEATURES

Augmenting the ADSP-21000 family core, the ADSP-21060 adds the following architectural features:

Dual-Ported On-Chip Memory

The ADSP-21060C contains four megabits of on-chip SRAM, organized as two blocks of 2 M bits each, which can be configured for different combinations of code and data storage. Each memory block is dual-ported for single-cycle, independent accesses by the core processor and I/O processor or DMA controller. The dual-ported memory and separate on-chip buses allow two data transfers from the core and one from I/O, all in a single cycle.

On the ADSP-21060C, the memory can be configured as a maximum of 128K words of 32-bit data, 256K words of 16-bit data, 80K words of 48-bit instructions (or 40-bit data), or combinations of different word sizes up to four megabits. All of the memory can be accessed as 16-bit, 32-bit, or 48-bit words.

A 16-bit floating-point storage format is supported that effectively doubles the amount of data that may be stored on-chip. Conversion between the 32-bit floating-point and 16-bit floating-point formats is done in a single instruction.

While each memory block can store combinations of code and data, accesses are most efficient when one block stores data, using the DM bus for transfers, and the other block stores instructions and data, using the PM bus for transfers. Using the DM bus and PM bus in this way, with one dedicated to each memory block, assures single-cycle execution with two data transfers. In this case, the instruction must be available in the cache. Single-cycle execution is also maintained when one of the data operands is transferred to or from off-chip, via the ADSP-2106x's external port.

Off-Chip Memory and Peripherals Interface

The AD SP-2106x's external port provides the processor's interface to off-chip memory and peripherals. The 4-gigaword off-chip address space is included in the AD SP-2106x's unified address space. The separate on-chip buses— for PM addresses, PM data, DM addresses, DM data, I/O addresses, and I/O data— are multiplexed at the external port to create an external system bus with a single 32-bit address bus and a single 48-bit (or 32-bit) data bus.

Addressing of external memory devices is facilitated by on-chip decoding of high-order address lines to generate memory bank select signals. Separate control lines are also generated for simplified addressing of page-mode DRAM. The AD SP-2106x provides programable memory wait states and external memory acknowledge controls to allow interfacing to DRAM and peripherals with variable access, hold, and disable time requirements.

Host Processor Interface

The AD SP-2106x's host interface allows easy connection to standard microprocessor buses, both 16-bit and 32-bit, with little additional hardware required. A synchronous transfers at speeds up to the full clock rate of the processor are supported. The host interface is accessed through the AD SP-2106x's external port and is memory-mapped into the unified address space. Four channels of DMA are available for the host interface; code and data transfers are accomplished with low software overhead.

The host processor requests the AD SP-2106x's external bus with the host bus request (**HBR**), host bus grant (**HBG**), and ready (**RDY**) signals. The host can directly read and write the internal memory of the AD SP-2106x, and can access the DMA channel setup and mailbox registers. Vector interrupt support is provided for efficient execution of host commands.

DMA Controller

The AD SP-2106x's on-chip DMA controller allows zero-overhead data transfers without processor intervention. The DMA controller operates independently and invisibly to the processor core, allowing DMA operations to occur while the core is simultaneously executing its program instructions.

DMA transfers can occur between the AD SP-2106x's internal memory and either external memory, external peripherals or a host processor. DMA transfers can also occur between the AD SP-2106x's internal memory and its serial ports or link ports. DMA transfers between external memory and external peripheral devices are another option. External bus packing to 16-, 32-, or 48-bit words is performed during DMA transfers.

Ten channels of DMA are available on the AD SP-2106x— two via the link ports, four via the serial ports, and four via the processor's external port (for either host processor, other AD SP-2106xs, memory or I/O transfers). Four additional link port DMA channels are shared with serial port 1 and the external port. Programs can be downloaded to the AD SP-2106x using DMA transfers. A synchronous off-chip peripherals can control two DMA channels using DMA Request/Grant lines (**DMARI-2**, **DMAGI-2**). Other DMA features include interrupt generation upon completion of DMA transfers and DMA chaining for automatic linked DMA transfers.

Serial Ports

The AD SP-2106x features two synchronous serial ports that provide an inexpensive interface to a wide variety of digital and mixed-signal peripheral devices. The serial ports can operate at the full clock rate of the processor, providing each with a maximum data rate of 40 M bit/s. Independent transmit and receive functions provide greater flexibility for serial communications. Serial port data can be automatically transferred to and from on-chip memory via DMA. Each of the serial ports offers TDM multichannel mode.

The serial ports can operate with little-endian or big-endian transmission formats, with word lengths selectable from 3 bits to 32 bits. They offer selectable synchronization and transmit modes as well as optional μ -law or A-law companding. Serial port clocks and frame syncs can be internally or externally generated.

Multiprocessing

The AD SP-2106x offers powerful features tailored to multiprocessing DSP systems. The unified address space (see Figure 4) allows direct interprocessor accesses of each AD SP-2106x's internal memory. Distributed bus arbitration logic is included on-chip for simple, glueless connection of systems containing up to six AD SP-2106xs and a host processor. Master processor changeover incurs only one cycle of overhead. Bus arbitration is selectable as either fixed or rotating priority. Bus lock allows indivisible **read-modify-write** sequences for semaphores. A vector interrupt is provided for interprocessor commands. Maximum throughput for interprocessor data transfer is 240 M bytes/s over the link ports or external port. **Broadcast writes** allow simultaneous transmission of data to all AD SP-2106xs and can be used to implement reflective semaphores.

Link Ports

The AD SP-2106x features six 4-bit link ports that provide additional I/O capabilities. The link ports can be clocked twice per cycle, allowing each to transfer eight bits per cycle. Link port I/O is especially useful for point-to-point interprocessor communication in multiprocessing systems.

The link ports can operate independently and simultaneously, with a maximum data throughput of 240 M bytes/s. Link port data is packed into 32- or 48-bit words, and can be directly read by the core processor or DMA-transferred to on-chip memory.

Each link port has its own double-buffered input and output registers. Clock/acknowledge handshaking controls link port transfers. Transfers are programable as either transmit or receive.

Program Booting

The internal memory of the AD SP-2106x can be booted at system power-up from either an 8-bit EPROM, a host processor, or through one of the link ports. Selection of the boot source is controlled by the **BMS** (Boot Memory Select), **EBOOT** (EPROM Boot), and **LBOOT** (Link Host Boot) pins. 32-bit and 16-bit host processors can be used for booting.

ADSP-21060C/ADSP-21060LC

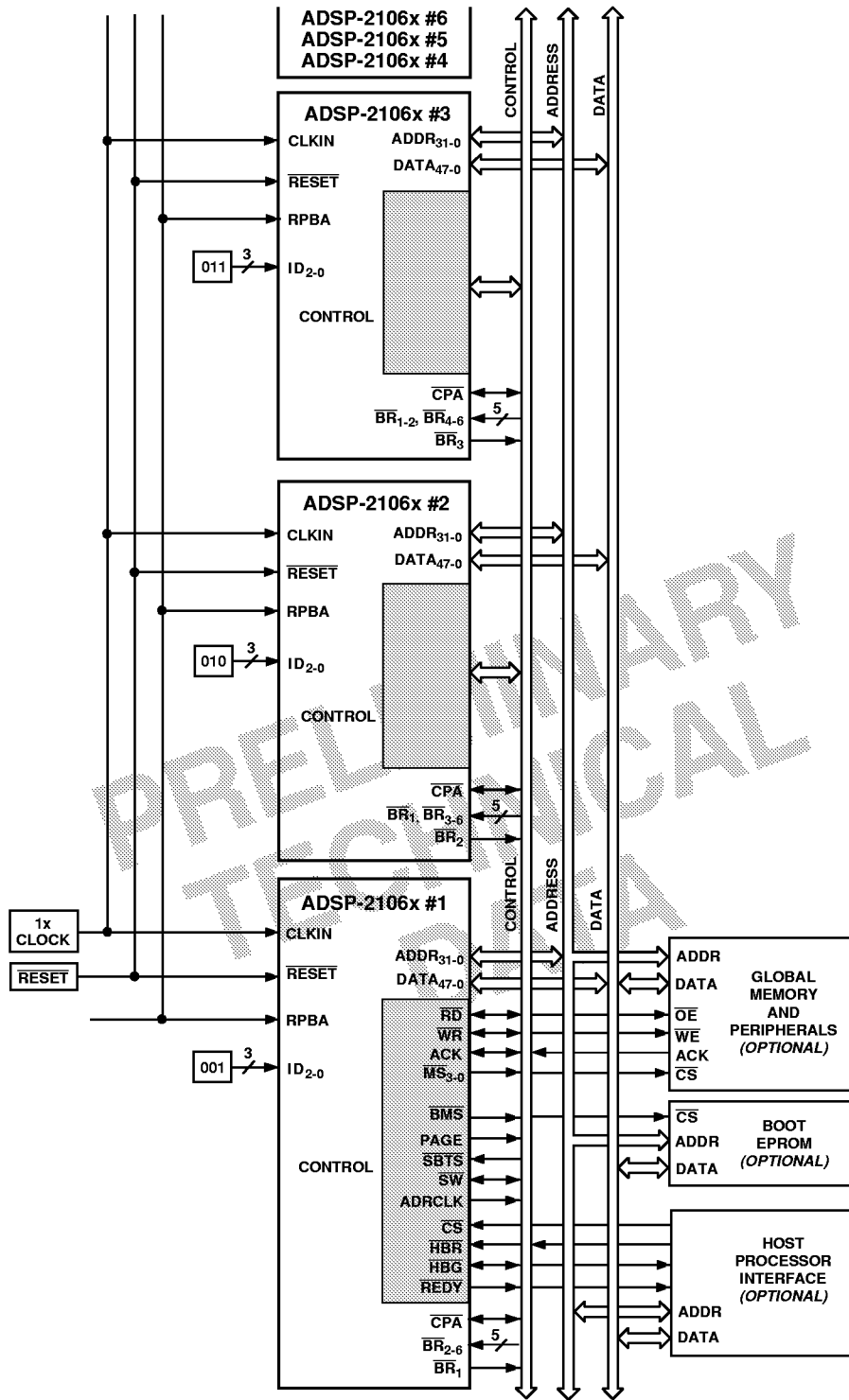

Figure 3. Shared Memory Multiprocessing System

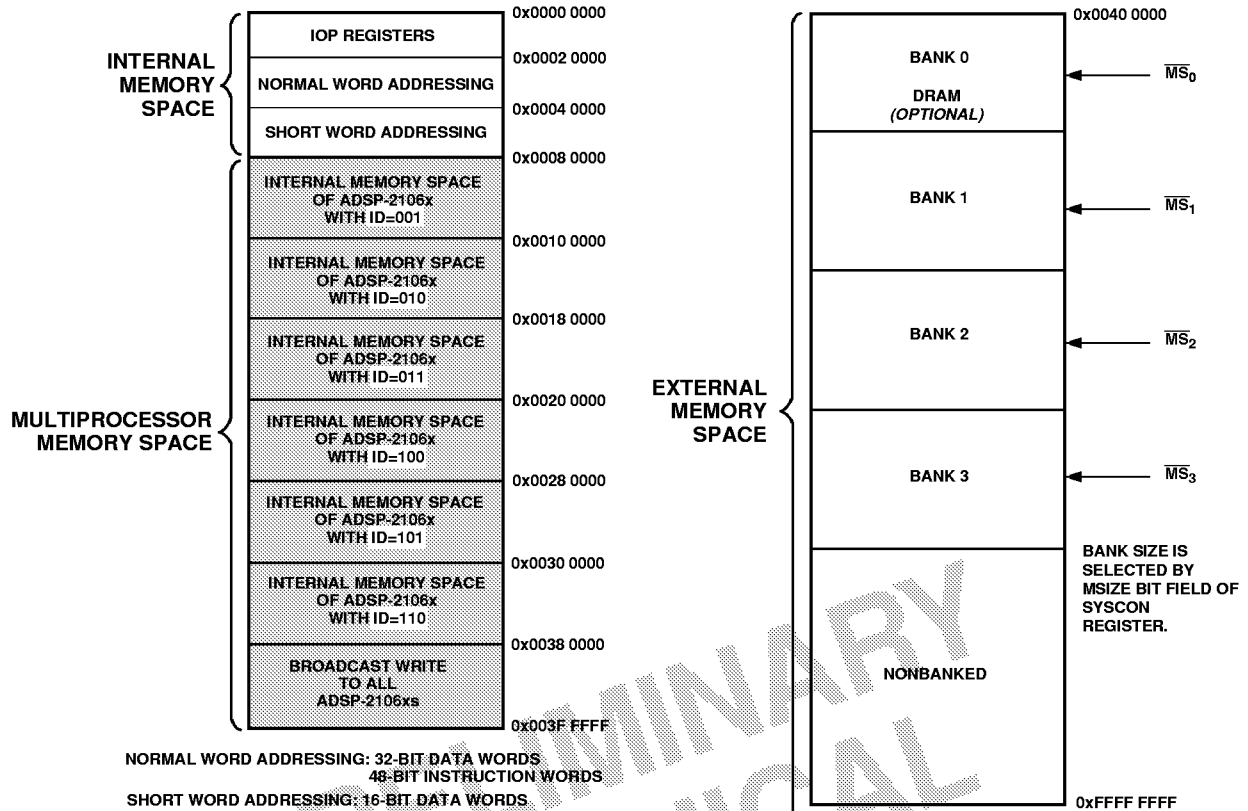

Figure 4. ADSP-21060C/ADSP-21060LC Memory Map

DEVELOPMENT TOOLS

The AD SP-21060C is supported with a complete set of software and hardware development tools, including an EZ-ICE In-Circuit Emulator, EZ-Kit, and development software. The SHARC EZ-Kit is a complete low cost package for DSP evaluation and prototyping. The EZ-Kit contains a PC plug-in card (EZ-LAB[®]) with an AD SP-21062 (5 V) processor. The EZ-Kit also includes an optimizing compiler, assembler, instruction level simulator, run-time libraries, diagnostic utilities and a complete set of example programs.

The same EZ-ICE hardware can be used for the AD SP-21061/AD SP-21062, to fully emulate the AD SP-21060C, with the exception of displaying and modifying the two new SPORTS registers. The emulator will not display these two registers, but your code can use them.

Analog Devices AD SP-21000 Family Development Software includes an easy to use Assembler based on an algebraic syntax, Assembly Library/Librarian, Linker, instruction-level simulator, an ANSIC optimizing Compiler, the C Bug™ C Source-Level Debugger and a C Runtime Library including DSP and mathematical functions. The Optimizing Compiler includes NumericalC extensions based on the work of the ANSINumericalC Extensions Group. NumericalC provides extensions to the C language for array selections, vector math operations, complex data types, circular pointers and variably dimensioned arrays.

CBUG and SHARCPAC are trademarks of Analog Devices, Inc.
EZ-LAB is a registered trademark of Analog Devices, Inc.

The AD SP-21000 Family Development Software is available for both the PC and Sun platform.

The AD SP-21061 EZ-ICE Emulator uses the IEEE 1149.1 JTAG test access port of the AD SP-21061 processor to monitor and control the target board processor during emulation. The EZ-ICE provides full-speed emulation, allowing inspection and modification of memory, registers, and processor stacks. Non-intrusive in-circuit emulation is assured by the use of the processor's JTAG interface—the emulator does not affect target system loading or timing.

Further details and ordering information are available in the *ADSP-21000 Family Hardware and Software Development Tools* data sheet (ADD S-210xx-TOOLS). This data sheet can be requested from any Analog Devices sales office or distributor.

In addition to the software and hardware development tools available from Analog Devices, third parties provide a wide range of tools supporting the SHARC processor family. Hardware tools include SHARC PC plug-in cards, multiprocessor SHARC VME boards, and daughter and modules with multiple SHARCs and additional memory. These modules are based on the SHARCPAC™ module specification. Third Party software tools include an Ada compiler, DSP libraries, operating systems and block diagram design tools.

ADDITIONAL INFORMATION

This data sheet provides a general overview of the AD SP-21060C architecture and functionality. For detailed information on the AD SP-21000 Family core architecture and instruction set, refer to the *ADSP-2106x SHARC User's Manual, Second Edition*.

ADSP-21060C/ADSP-21060LC

PIN FUNCTION DESCRIPTIONS

ADSP-21060C pin definitions are listed below. All pins are identical on the ADSP-21060C and ADSP-21060LC. Inputs identified as synchronous (S) must meet timing requirements with respect to CLK IN (or with respect to TCK for TMS, TDI). Inputs identified as asynchronous (A) can be asserted asynchronously to CLK IN (or to TCK for TRST).

Unused inputs should be tied or pulled to VDD or GND, except for ADDR₃₁₋₀, DATA₄₇₋₀, FLAG₃₋₀, \overline{SW} , and inputs that have internal pull-up or pull-down resistors (\overline{CPA} , ACK, DTx,

DRx, TCLKx, RCLKx, LxDAT3-0, LxCCLK, LxACK, TMS and TDI)– these pins can be left floating. These pins have a logic-level hold circuit that prevents the input from floating internally.

A = Asynchronous G = Ground I = Input
 O = Output P = Power Supply S = Synchronous
 (A \overline{D}) = Active Drive ($\overline{O\overline{D}}$) = Open Drain
 T = Three-State (when \overline{SBTS} is asserted, or when the ADSP-2106x is a bus slave)

Pin	Type	Function
ADDR ₃₁₋₀	I/O /T	External Bus Address. The ADSP-2106x outputs addresses for external memory and peripherals on these pins. In a multiprocessor system, the bus master outputs addresses for read/writes of the internal memory or IOP registers of other ADSP-2106xs. The ADSP-2106x inputs addresses when a host processor or multiprocessing bus master is reading or writing its internal memory or IOP registers.
DATA ₄₇₋₀	I/O /T	External Bus Data. The ADSP-2106x inputs and outputs data and instructions on these pins. 32-bit single-precision floating-point data and 32-bit fixed-point data is transferred over bits 47–16 of the bus. 40-bit extended-precision floating-point data is transferred over bits 47–8 of the bus. 16-bit short word data is transferred over bits 31–16 of the bus. In PROM boot mode, 8-bit data is transferred over bits 23–16. Pull-up resistors on unused DATA pins are not necessary.
\overline{MS}_{3-0}	O /T	Memory Select Lines. These lines are asserted (low) as chip selects for the corresponding banks of external memory. Memory bank size must be defined in the ADSP-2106x's system control register (SYSCON). The \overline{MS}_{3-0} lines are decoded memory address lines that change at the same time as the other address lines. When no external memory access is occurring the \overline{MS}_{3-0} lines are inactive; they are active however when a conditional memory access instruction is executed, whether or not the condition is true. \overline{MS}_0 can be used with the PAGE signal to implement a bank of DRAM memory (Bank 0). In a multiprocessing system, the \overline{MS}_{3-0} lines are output by the bus master.
\overline{RD}	I/O /T	Memory Read Strobe. This pin is asserted (low) when the ADSP-2106x reads from external memory devices or from the internal memory of other ADSP-2106xs. External devices (including other ADSP-2106xs) must assert \overline{RD} to read from the ADSP-2106x's internal memory. In a multiprocessing system, \overline{RD} is output by the bus master and is input by all other ADSP-2106xs.
\overline{WR}	I/O /T	Memory Write Strobe. This pin is asserted (low) when the ADSP-2106x writes to external memory devices or to the internal memory of other ADSP-2106xs. External devices must assert \overline{WR} to write to the ADSP-2106x's internal memory. In a multiprocessing system, \overline{WR} is output by the bus master and is input by all other ADSP-2106xs.
PAGE	O /T	DRAM Page Boundary. The ADSP-2106x asserts this pin to signal that an external DRAM page boundary has been crossed. DRAM page size must be defined in the ADSP-2106x's memory control register (WAT). DRAM can only be implemented in external memory Bank 0; the PAGE signal can only be activated for Bank 0 accesses. In a multiprocessing system, PAGE is output by the bus master.
ADRCCLK	O /T	Clock Output Reference. In a multiprocessing system, ADRCCLK is output by the bus master.
\overline{SW}	I/O /T	Synchronous Write Select. This signal is used to interface the ADSP-2106x to synchronous memory devices (including other ADSP-2106xs). The ADSP-2106x asserts \overline{SW} (low) to provide an early indication of an impending write cycle, which can be aborted if \overline{WR} is not later asserted (e.g., in a conditional write instruction). In a multiprocessing system, \overline{SW} is output by the bus master and is input by all other ADSP-2106xs to determine if the multiprocessor memory access is a read or write. \overline{SW} is asserted at the same time as the address output. A host processor using synchronous writes must assert this pin when writing to the ADSP-2106x(s).
ACK	I/O /S	Memory Acknowledge. External devices can deassert ACK (low) to add wait states to an external memory access. ACK is used by I/O devices, memory controllers, or other peripherals to hold off completion of an external memory access. The ADSP-2106x deasserts ACK as an output to add wait states to a synchronous access of its internal memory. In a multiprocessing system, a slave ADSP-2106x deasserts the bus master's ACK input to add wait state(s) to an access of its internal memory. The bus master has a keeper latch on its ACK pin that maintains the input at the level to which it was last driven.

Pin	Type	Function
$\overline{\text{SBTS}}$	I/S	Suspend Bus Three-State. External devices can assert $\overline{\text{SBTS}}$ (low) to place the external bus address, data, selects and strobes in a high impedance state for the following cycle. If the AD SP-2106x attempts to access external memory while $\overline{\text{SBTS}}$ is asserted, the processor will halt and the memory access will not be completed until $\overline{\text{SBTS}}$ is deasserted. $\overline{\text{SBTS}}$ should only be used to recover from host processor/AD SP-2106x deadlock, or used with a DRAM controller.
$\overline{\text{IRQ}}_{2-0}$	I/A	Interrupt Request Lines. May be either edge-triggered or level-sensitive.
FLAG_{3-0}	I/O $\overline{\text{A}}$	Flag Pins. Each is configured via control bits as either an input or output. As an input, it can be tested as a condition. As an output, it can be used to signal external peripherals.
TIM EXP	O	Timer Expired. Asserted for four cycles when the timer is enabled and T COUNT decrements to zero.
$\overline{\text{HBR}}$	I/A	Host Bus Request. Must be asserted by a host processor to request control of the AD SP-2106x's external bus. When $\overline{\text{HBR}}$ is asserted in a multiprocessing system, the AD SP-2106x that is bus master will relinquish the bus and assert $\overline{\text{HBG}}$. To relinquish the bus, the AD SP-2106x places the address, data, select and strobe lines in a high impedance state. $\overline{\text{HBR}}$ has priority over all AD SP-2106x bus requests ($\overline{\text{BR}}_{6-1}$) in a multiprocessing system.
$\overline{\text{HBG}}$	I/O	Host Bus Grant. Acknowledges an $\overline{\text{HBR}}$ bus request, indicating that the host processor may take control of the external bus. $\overline{\text{HBG}}$ is asserted (held low) by the AD SP-2106x until $\overline{\text{HBR}}$ is released. In a multiprocessing system, $\overline{\text{HBG}}$ is output by the AD SP-2106x bus master and is monitored by all others.
$\overline{\text{CS}}$	I/A	Chip Select. Asserted by host processor to select the AD SP-2106x.
RED Y (O/D)	O	Host Bus Acknowledge. The AD SP-2106x deasserts RED Y (low) to add wait states to an asynchronous access of its internal memory or IOP registers by a host. Open drain output (O/D) by default; can be programmed in AD RED Y bit of SYSCON register to be active drive (A/D). RED Y will only be output if the $\overline{\text{CS}}$ and $\overline{\text{HBR}}$ inputs are asserted.
$\overline{\text{DMAR1}}$	I/A	DMA Request 1 (DMA Channel 7).
$\overline{\text{DMAR2}}$	I/A	DMA Request 2 (DMA Channel 8).
$\overline{\text{DMAG1}}$	O/T	DMA Grant 1 (DMA Channel 7).
$\overline{\text{DMAG2}}$	O/T	DMA Grant 2 (DMA Channel 8).
$\overline{\text{BR}}_{6-1}$	I/O $\overline{\text{S}}$	Multiprocessing Bus Requests. Used by multiprocessing AD SP-2106xs to arbitrate for bus mastership. An AD SP-2106x only drives its own $\overline{\text{BR}}_x$ line (corresponding to the value of its ID_{2-0} inputs) and monitors all others. In a multiprocessor system with less than six AD SP-2106xs, the unused $\overline{\text{BR}}_x$ pins should be pulled high; the processor's own $\overline{\text{BR}}_x$ line must not be pulled high or low because it is an output.
ID_{2-0}	I	Multiprocessing ID. Identifies which multiprocessing bus request ($\overline{\text{BR}}_1 - \overline{\text{BR}}_6$) is used by AD SP-2106x. $\text{ID} = 001$ corresponds to $\overline{\text{BR}}_1$, $\text{ID} = 010$ corresponds to $\overline{\text{BR}}_2$, etc. $\text{ID} = 000$ in single-processor systems. These lines are a system configuration selection which should be hardwired or only changed at reset.
RPBA	I/S	Rotating Priority Bus Arbitration Select. When RPBA is high, rotating priority for multiprocessor bus arbitration is selected. When RPBA is low, fixed priority is selected. This signal is a system configuration selection which must be set to the same value on every AD SP-2106x. If the value of RPBA is changed during system operation, it must be changed in the same CLK IN cycle on every AD SP-2106x.
$\overline{\text{CPA}} \text{ (O/D)}$	I/O	Core Priority Access. Asserting its $\overline{\text{CPA}}$ pin allows the core processor of an AD SP-2106x bus slave to interrupt background DMA transfers and gain access to the external bus. $\overline{\text{CPA}}$ is an open drain output that is connected to all AD SP-2106xs in the system. The $\overline{\text{CPA}}$ pin has an internal 5 k Ω pull-up resistor. If core access priority is not required in a system, the $\overline{\text{CPA}}$ pin should be left unconnected.
DT_x	O	Data Transmit (Serial Ports 0, 1). Each DT pin has a 50 k Ω internal pull-up resistor.
DR_x	I	Data Receive (Serial Ports 0, 1). Each DR pin has a 50 k Ω internal pull-up resistor.
TCLK_x	I/O	Transmit Clock (Serial Ports 0, 1). Each TCLK pin has a 50 k Ω internal pull-up resistor.
RCLK_x	I/O	Receive Clock (Serial Ports 0, 1). Each RCLK pin has a 50 k Ω internal pull-up resistor.

ADSP-21060C/ADSP-21060LC

Pin	Type	Function																												
TFSx	I/O	Transmit Frame Sync (Serial Ports 0, 1).																												
RFSx	I/O	Receive Frame Sync (Serial Ports 0, 1).																												
LxD TA ₃₋₀	I/O	Link Port Data (Link Ports 0–5). Each LxCLK pin has a 50 kΩ internal pull-down resistor that is enabled or disabled by the LPDRD bit of the LCOM register.																												
LxC LK	I/O	Link Port Clock (Link Ports 0–5). Each LxC LK pin has a 50 kΩ internal pull-down resistor that is enabled or disabled by the LPDRD bit of the LCOM register.																												
LxACK	I/O	Link Port Acknowledge (Link Ports 0–5). Each LxACK pin has a 50 kΩ internal pull-down resistor that is enabled or disabled by the LPDRD bit of the LCOM register.																												
EBOOT	I	EPROM Boot Select . When EBOOT is high, the ADSP-2106x is configured for booting from an 8-bit EPROM. When EBOOT is low, the LBOOT and $\overline{\text{BMS}}$ inputs determine booting mode. See table below. This signal is a system configuration selection that should be hardware.																												
LBOOT	I	Link Boot . When LBOOT is high, the ADSP-2106x is configured for link port booting. When LBOOT is low, the ADSP-2106x is configured for host processor booting or no booting. See table below. This signal is a system configuration selection that should be hardware.																												
$\overline{\text{BMS}}$	I/O / T*	Boot Memory Select . <i>Output</i> : Used as chip select for boot EPROM devices (when EBOOT = 1, LBOOT = 0). In a multiprocessor system, $\overline{\text{BMS}}$ is output by the bus master. <i>Input</i> : When low, indicates that no booting will occur and that ADSP-2106x will begin executing instructions from external memory. See table below. This input is a system configuration selection that should be hardware. *Three-statable only in EPROM boot mode (when $\overline{\text{BMS}}$ is an output).																												
		<table border="1"> <thead> <tr> <th>EBOOT</th> <th>LBOOT</th> <th>$\overline{\text{BMS}}$</th> <th>Booting Mode</th> </tr> </thead> <tbody> <tr> <td>1</td> <td>0</td> <td>Output</td> <td>EPROM (Connect $\overline{\text{BMS}}$ to EPROM chip select.)</td> </tr> <tr> <td>0</td> <td>0</td> <td>1 (Input)</td> <td>Host Processor</td> </tr> <tr> <td>0</td> <td>1</td> <td>1 (Input)</td> <td>Link Port</td> </tr> <tr> <td>0</td> <td>0</td> <td>0 (Input)</td> <td>No Booting. Processor executes from external memory.</td> </tr> <tr> <td>0</td> <td>1</td> <td>0 (Input)</td> <td>Reserved</td> </tr> <tr> <td>1</td> <td>1</td> <td>x (Input)</td> <td>Reserved</td> </tr> </tbody> </table>	EBOOT	LBOOT	$\overline{\text{BMS}}$	Booting Mode	1	0	Output	EPROM (Connect $\overline{\text{BMS}}$ to EPROM chip select.)	0	0	1 (Input)	Host Processor	0	1	1 (Input)	Link Port	0	0	0 (Input)	No Booting. Processor executes from external memory.	0	1	0 (Input)	Reserved	1	1	x (Input)	Reserved
EBOOT	LBOOT	$\overline{\text{BMS}}$	Booting Mode																											
1	0	Output	EPROM (Connect $\overline{\text{BMS}}$ to EPROM chip select.)																											
0	0	1 (Input)	Host Processor																											
0	1	1 (Input)	Link Port																											
0	0	0 (Input)	No Booting. Processor executes from external memory.																											
0	1	0 (Input)	Reserved																											
1	1	x (Input)	Reserved																											
CLK IN	I	Clock In . External clock input to the ADSP-2106x. The instruction cycle rate is equal to CLK IN. CLK IN may not be halted, changed, or operated below the minimum specified frequency.																												
$\overline{\text{RESET}}$	I/A	Processor Reset . Resets the ADSP-2106x to a known state and begins execution at the program memory location specified by the hardware reset vector address. This input must be asserted (low) at power-up.																												
TCK	I	Test Clock (JTAG) . Provides an asynchronous clock for JTAG boundary scan.																												
TMS	I/S	Test Mode Select (JTAG) . Used to control the test state machine. TMS has a 20 kΩ internal pull-up resistor.																												
TDI	I/S	Test Data Input (JTAG) . Provides serial data for the boundary scan logic. TDI has a 20 kΩ internal pull-up resistor.																												
TDO	O	Test Data Output (JTAG) . Serial scan output of the boundary scan path.																												
$\overline{\text{TRST}}$	I/A	Test Reset (JTAG) . Resets the test state machine. $\overline{\text{TRST}}$ must be asserted (pulsed low) after power-up or held low for proper operation of the ADSP-2106x. $\overline{\text{TRST}}$ has a 20 kΩ internal pull-up resistor.																												
$\overline{\text{EMU}}$ (O/D)	O	Emulation Status . Must be connected to the ADSP-2106x EZ-ICE target board connector <i>only</i> .																												
ICSA	O	Reserved , leave unconnected.																												
VDD	P	Power Supply ; nominally +5.0 V dc for 5 V devices or +3.3 V dc for 3.3 V devices. (30 pins).																												
GND	G	Power Supply Return . (30 pins).																												
NC		Do Not Connect . Reserved pins which must be left open and unconnected.																												

TARGET BOARD CONNECTOR FOR EZ-ICE PROBE

The ADSP-2106x EZ-ICE Emulator uses the IEEE 1149.1 JTAG test access port of the ADSP-2106x to monitor and control the target board processor during emulation. The EZ-ICE probe requires the ADSP-2106x's CLK IN, TMS, TCK, $\overline{\text{TRST}}$, TDI, TDO, $\overline{\text{EMU}}$, and GND signals be made accessible on the target system via a 14-pin connector (a 2 row \times 7 pin strip header) such as that shown in Figure 5. The EZ-ICE probe plugs directly onto this connector for chip-on-board emulation. You must add this connector to your target board design if you intend to use the ADSP-2106x EZ-ICE. The total trace length between the EZ-ICE connector and the furthest device sharing the EZ-ICE JTAG pins should be limited to 15 inches maximum for guaranteed operation. This length restriction must include EZ-ICE JTAG signals that are routed to one or more ADSP-2106x devices, or a combination of ADSP-2106x devices and other JTAG devices on the chain.

The 14-pin, 2-row pin strip header is keyed at the Pin 3 location – Pin 3 must be removed from the header. The pins must be 0.025 inch square and at least 0.20 inch in length. Pin spacing should be 0.1 \times 0.1 inches. Pin strip headers are available from vendors such as 3M, MCKENZIE and Samtec.

The BTMS, BTCK, $\overline{\text{BTRST}}$ and BTDI signals are provided so the test access port can also be used for board-level testing. When the connector is not being used for emulation, place jumpers between the Bxxx pins and the xxx pins. If the test access port will not be used for board testing, tie $\overline{\text{BTRST}}$ to GND and tie or pull BTCK up to VDD. The $\overline{\text{TRST}}$ pin must be asserted after power-up (through $\overline{\text{BTRST}}$ on the connector) or held low for proper operation of the ADSP-2106x. None of the Bxxx pins (Pins 5, 7, 9, 11) are connected on the EZ-ICE probe.

The JTAG signals are terminated on the EZ-ICE probe as follows:

Signal	Termination
TMS	Driven through 22 Ω Resistor (16 mA Driver)
TCK	Driven at 10 MHz through 22 Ω Resistor (16 mA Driver)
$\overline{\text{TRST}}$ *	Active Low Driven through 22 Ω Resistor (16 mA Driver) (Pulled Up by On-Chip 20 k Ω Resistor)
TDI	Driven by 22 Ω Resistor (16 mA Driver)
TDO	One TTL Load, Split Termination (160/220)
CLK IN	One TTL Load, Split Termination (160/220)
$\overline{\text{EMU}}$	Active Low 4.7 k Ω Pull-Up Resistor, One TTL Load (Open Drain Output from the DSP)

* $\overline{\text{TRST}}$ is driven low until the EZ-ICE probe is turned on by the emulator at software start-up. After software start-up, $\overline{\text{TRST}}$ is driven high.

Figure 6 shows JTAG scan path connections for systems that contain multiple ADSP-2106x processors.

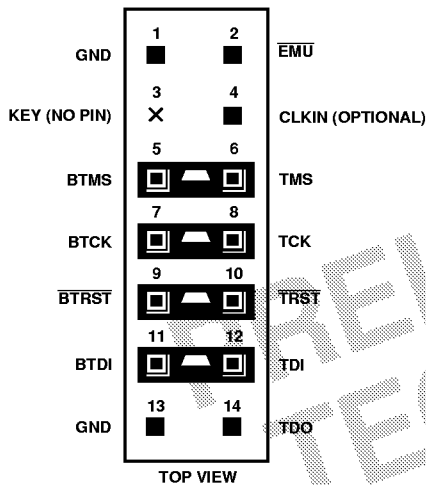

Figure 5. Target Board Connector For ADSP-2106x EZ-ICE Emulator (Jumpers in Place)

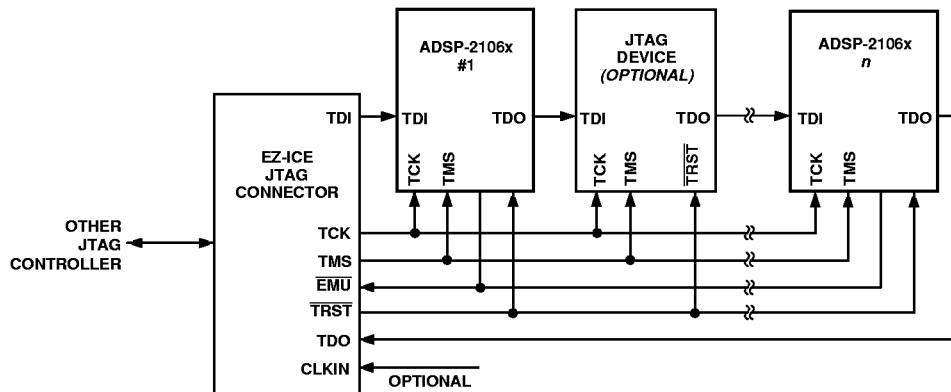

Figure 6. JTAG Scan Path Connections for Multiple ADSP-2106x Systems

ADSP-21060C/ADSP-21060LC

Connecting CLK IN to Pin 4 of the EZ-ICE header is optional. The emulator only uses CLK IN when directed to perform operations such as starting, stopping and single-stepping multiple ADSP-21061 in a *synchronous* manner. If you do not need these operations to occur synchronously on the multiple processors, simply tie Pin 4 of the EZ-ICE header to ground.

If synchronous multiprocessor operations are needed and CLK IN is connected, clock skew between the multiple ADSP-21061/ADSP-21061L processors and the CLK IN pin on the EZ-ICE header *must be minimal*. If the skew is too large, synchronous operations may be off by one or more cycles between processors. For synchronous multiprocessor operation TCK, TMS, CLK IN and \overline{EMU} should be treated as critical signals in terms of skew, and should be laid out as short as possible on your board. If TCK, TMS and CLK IN are driving a large number of ADSP-21061 (more than eight) in your system, then treat them as a clock tree using multiple drivers to minimize skew. (See Figure 7, JTAG Clock Tree, and Clock Distribution in the High Frequency Design Considerations section of the *ADSP-2106x User's Manual, Second Edition*.)

If synchronous multiprocessor operations are not needed (i.e., CLK IN is not connected), just use appropriate parallel termination on TCK and TMS. TDI, TDO, \overline{EMU} and \overline{TRST} are not critical signals in terms of skew.

For complete information on the SHARC EZ-ICE, see the *ADSP-2100 Family JTAG EZ-ICE User's Guide and Reference*.

For complete information on the SHARC EZ-ICE, see the *ADSP-2100 Family JTAG EZ-ICE User's Guide and Reference*.

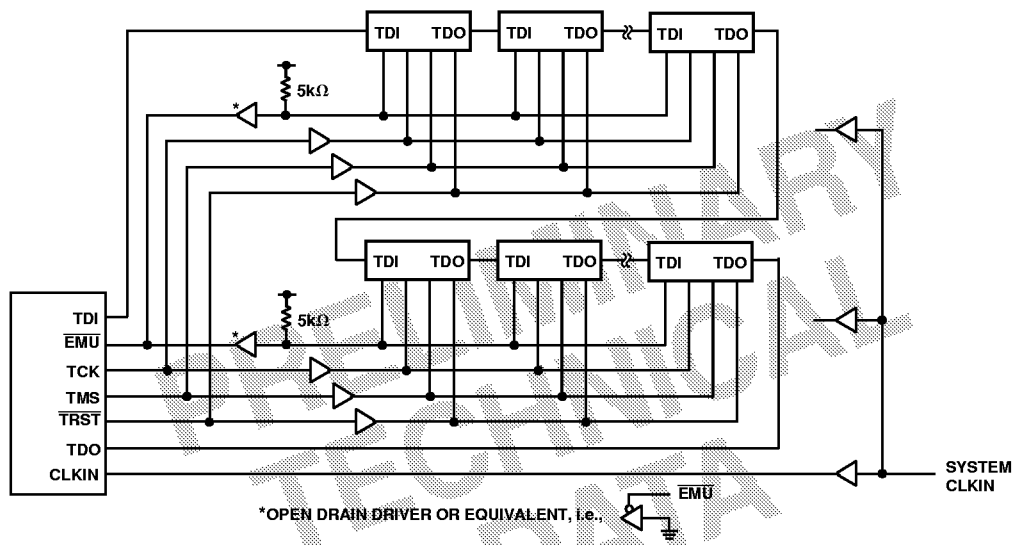

Figure 7. JTAG Clocktree for Multiple ADSP-2106x Systems

ADSP-21060C—SPECIFICATIONS

RECOMMENDED OPERATING CONDITIONS (5 V)

Parameter	Test Conditions	K Grade		Units
		Min	Max	
V _{DD}	Supply Voltage	4.75	5.25	V
T _{CASE}	Case Operating Temperature	-40	+100	°C
V _{IH1}	High Level Input Voltage ¹	@ V _{DD} = max	V _{DD} + 0.5	V
V _{IH2}	High Level Input Voltage ²	@ V _{DD} = max	V _{DD} + 0.5	V
V _{IL}	Low Level Input Voltage ^{1,2}	@ V _{DD} = min	0.8	V

NOTES

¹Applies to input and bidirectional pins: DATA₄₇₋₀, ADDR₃₁₋₀, \overline{RD} , \overline{WR} , \overline{SW} , \overline{ACK} , \overline{SBTS} , \overline{IRQ} ₃₋₀, FLAG₃₋₀, \overline{HBG} , \overline{CS} , $\overline{DMAR1}$, $\overline{DMAR2}$, \overline{BR} ₆₋₁, ID₃₋₀, RPBA, CPA, TFS0, TFS1, RFS0, RFS1, LxDAT₃₋₀, LxCCLK, LxACK, EBOOT, LBOOT, BMS, TMS, TDI, TCK, HBR, DR0, DR1, TCLK0, TCLK1, RCLK0, RCLK1.

²Applies to input pins: CLKIN, RESET, TRST.

ELECTRICAL CHARACTERISTICS (5 V)

Parameter	Test Conditions	Min	Max	Units
V _{OH}	High Level Output Voltage ¹	@ V _{DD} = min, I _{OH} = -2.0 mA ²	4.1	V
V _{OL}	Low Level Output Voltage ¹	@ V _{DD} = min, I _{OL} = 4.0 mA ²	0.4	V
I _{IH}	High Level Input Current ^{3,4}	@ V _{DD} = max, V _{IN} = V _{DD} max	10	μA
I _{IL}	Low Level Input Current ³	@ V _{DD} = max, V _{IN} = 0 V	10	μA
I _{IHP}	Low Level Input Current ⁴	@ V _{DD} = max, V _{IN} = 0 V	150	μA
I _{OZH}	Three-State Leakage Current ^{5,6,7,8}	@ V _{DD} = max, V _{IN} = V _{DD} max	10	μA
I _{OZL}	Three-State Leakage Current ^{5,8}	@ V _{DD} = max, V _{IN} = 0 V	10	μA
I _{OZHP}	Three-State Leakage Current ⁹	@ V _{DD} = max, V _{IN} = V _{DD} max	350	μA
I _{OZLC}	Three-State Leakage Current ⁷	@ V _{DD} = max, V _{IN} = 0 V	1.5	mA
I _{OZLA}	Three-State Leakage Current ¹⁰	@ V _{DD} = max, V _{IN} = 1.5 V	350	μA
I _{OZLAR}	Three-State Leakage Current ⁸	@ V _{DD} = max, V _{IN} = 0 V	4.2	mA
I _{OZLS}	Three-State Leakage Current ⁶	@ V _{DD} = max, V _{IN} = 0 V	150	μA
C _{IN}	Input Capacitance ^{11,12}	f _{IN} = 1 MHz, T _{CASE} = 25°C, V _{IN} = 2.5 V	4.7	pF

NOTES

¹Applies to output and bidirectional pins: DATA₄₇₋₀, ADDR₃₁₋₀, \overline{MS} ₃₋₀, \overline{RD} , \overline{WR} , PAGE, ADDRCLK, \overline{SW} , \overline{ACK} , FLAG₃₋₀, TMEXP, \overline{HBG} , REDY, $\overline{DMAG1}$, $\overline{DMAG2}$, \overline{BR} ₆₋₁, CPA, DT0, DT1, TCLK0, TCLK1, RCLK0, RCLK1, TFS0, TFS1, RFS0, RFS1, LxDAT₃₋₀, LxCCLK, LxACK, BMS, TD0, EMU, IC SA.

²See "Output Drive Currents" for typical drive current capabilities.

³Applies to input pins: \overline{ACK} , \overline{SBTS} , \overline{IRQ} ₃₋₀, HBR, CS, $\overline{DMAR1}$, $\overline{DMAR2}$, ID₃₋₀, RPBA, EBOOT, LBOOT, CLKIN, RESET, TCK.

⁴Applies to input pins with internal pull-ups: DR0, DR1, TRST, TMS, TDI.

⁵Applies to three-statable pins: DATA₄₇₋₀, ADDR₃₁₋₀, \overline{MS} ₃₋₀, \overline{RD} , \overline{WR} , PAGE, ADDRCLK, \overline{SW} , \overline{ACK} , FLAG₃₋₀, REDY, \overline{HBG} , $\overline{DMAG1}$, $\overline{DMAG2}$, BMS, \overline{BR} ₆₋₁, TFS_x, RFS_x, TD0, EMU. (Note that ACK is pulled up internally with 2 kΩ during reset in a multiprocessor system, when ID₃₋₀ = 001 and another ADSP-21062 is not requesting bus mastership.)

⁶Applies to three-statable pins with internal pull-ups: DT0, DT1, TCLK0, TCLK1, RCLK0, RCLK1.

⁷Applies to CPA pin.

⁸Applies to ACK pin when pulled up. (Note that ACK is pulled up internally with 2 kΩ during reset in a multiprocessor system, when ID₃₋₀ = 001 and another ADSP-21060LC is not requesting bus mastership.)

⁹Applies to three-statable pins with internal pull-downs: LxDAT₃₋₀, LxCCLK, LxACK.

¹⁰Applies to ACK pin when keeper latch enabled.

¹¹Applies to all signal pins.

¹²Guaranteed but not tested.

Specifications subject to change without notice.

ADSP-21060C/ADSP-21060LC

POWER DISSIPATION ADSP-21060C (5 V)

These specifications apply to the internal power portion of V_{DD} only. See the Power Dissipation section of this data sheet for calculation of external supply current and total supply current. For a complete discussion of the code used to measure power dissipation, see the technical note "SHARC Power Dissipation Measurements."

Specifications are based on the following operating scenarios:

Operation	Peak Activity ($I_{DDINPEAK}$)	High Activity ($I_{DDINHGH}$)	Low Activity ($I_{DDINLOW}$)
Instruction Type	Multifunction	Multifunction	Single Function
Instruction Fetch	Cache	Internal Memory	Internal Memory
Core Memory Access	2 per Cycle (DM and PM)	1 per Cycle (DM)	None
Internal Memory DMA	1 per Cycle	1 per 2 Cycles	1 per 2 Cycles

To estimate power consumption for a specific application, use the following equation where % is the amount of time your program spends in that state:

$$\% PEAK \times I_{DDINPEAK} + \%HIGH \times I_{DDINHGH} + \%LOW \times I_{DDINLOW} + \%IDLE \times I_{DDIDLE} = \text{power consumption}$$

Parameter	Test Conditions	Max	Units
$I_{DDINPEAK}$ Supply Current (Internal) ¹	$t_{CK} = 30 \text{ ns}, V_{DD} = \text{max},$ $t_{CK} = 25 \text{ ns}, V_{DD} = \text{max},$	745 850	mA mA
$I_{DDINHGH}$ Supply Current (Internal) ²	$t_{CK} = 30 \text{ ns}, V_{DD} = \text{max},$ $t_{CK} = 25 \text{ ns}, V_{DD} = \text{max},$	575 670	mA mA
$I_{DDINLOW}$ Supply Current (Internal) ²	$t_{CK} = 30 \text{ ns}, V_{DD} = \text{max},$ $t_{CK} = 25 \text{ ns}, V_{DD} = \text{max},$	340 390	mA mA
I_{DDIDLE} Supply Current (Idle) ³	$V_{DD} = \text{max}$	200	mA

NOTES

¹The test program used to measure $I_{DDINPEAK}$ represents worst case processor operation and is not sustainable under normal application conditions. Actual internal power measurements made using typical applications are less than specified.

² $I_{DDINHGH}$ is a composite average based on a range of high activity code. $I_{DDINLOW}$ is a composite average based on a range of low activity code.

³Idle denotes ADSP-21060LC state during execution of IDLE instruction.

ADSP-21060LC-SPECIFICATIONS

RECOMMENDED OPERATING CONDITIONS (3.3 V)

Parameter	Test Conditions	K Grade		Units
		Min	Max	
V _{DD}	Supply Voltage	3.15	3.45	V
T _{CASE}	Case Operating Temperature	-40	+100	°C
V _{IH1}	High Level Input Voltage ¹	@ V _{DD} = max	V _{DD} + 0.5	V
V _{IH2}	High Level Input Voltage ²	@ V _{DD} = max	V _{DD} + 0.5	V
V _{IL}	Low Level Input Voltage ^{1,2}	@ V _{DD} = min	0.8	V

NOTES

¹Applies to input and bidirectional pins: DATA₄₇₋₀, ADDR₃₁₋₀, RD, WR, SW, ACK, SBTS, IRQ₂₋₀, FLAG₃₋₀, HBG, CS, DMAR1, DMAR2, BR₆₋₁, ID₂₋₀, RPBA, CPA, TFS0, TFS1, RFS0, RFS1, LxDAT₃₋₀, LxCLK, LxACK, EBOOT, LBOOT, BMS, TM S, TD L, TCK, HBR, DRO, DR1, TCLK0, TCLK1, RCLK0, RCLK1.

²Applies to input pins: CLK IN, RESET, TRST.

ELECTRICAL CHARACTERISTICS (3.3 V)

Parameter	Test Conditions	Min	Max	Units
V _{OH}	High Level Output Voltage ¹	@ V _{DD} = min, I _{OH} = -2.0 mA ²	2.4	V
V _{OL}	Low Level Output Voltage ¹	@ V _{DD} = min, I _{OL} = 4.0 mA ²	0.4	V
I _{IH}	High Level Input Current ³	@ V _{DD} = max, V _{IN} = V _{DD} max	10	μA
I _{IL}	Low Level Input Current ³	@ V _{DD} = max, V _{IN} = 0 V	10	μA
I _{ILP}	Low Level Input Current ⁴	@ V _{DD} = max, V _{IN} = 0 V	150	μA
I _{OZH}	Three-State Leakage Current ^{5, 6, 7, 8}	@ V _{DD} = max, V _{IN} = V _{DD} max	10	μA
I _{OZL}	Three-State Leakage Current ^{8, 9}	@ V _{DD} = max, V _{IN} = 0 V	10	μA
I _{OZHP}	Three-State Leakage Current ⁹	@ V _{DD} = max, V _{IN} = V _{DD} max	350	μA
I _{OZLC}	Three-State Leakage Current ⁷	@ V _{DD} = max, V _{IN} = 0 V	1.5	mA
I _{OZLA}	Three-State Leakage Current ¹⁰	@ V _{DD} = max, V _{IN} = 2 V	350	μA
I _{OZLAR}	Three-State Leakage Current ⁸	@ V _{DD} = max, V _{IN} = 0 V	4.2	mA
I _{OZLS}	Three-State Leakage Current ⁶	@ V _{DD} = max, V _{IN} = 0 V	150	μA
C _{IN}	Input Capacitance ^{11, 12}	f _{IN} = 1 MHz, T _{CASE} = 25°C, V _{IN} = 2.5 V	4.7	pF

NOTES

¹Applies to output and bidirectional pins: DATA₄₇₋₀, ADDR₃₁₋₀, MS₃₋₀, RD, WR, PAGE, ADRCLK, SW, ACK, FLAG₃₋₀, TM EXP, HBG, REDY, DMAG1, DMAG2, BR₆₋₁, CPA, D T O, D T 1, TCLK0, TCLK1, RCLK0, RCLK1, TFS0, TFS1, RFS0, RFS1, LxDAT₃₋₀, LxCLK, LxACK, BMS, T D O, EMU, IC SA.

²See "Output Drive Currents" for typical drive current capabilities.

³Applies to input pins: ACK, SBTS, IRQ₂₋₀, HBR, CS, DMAR1, DMAR2, ID₂₋₀, RPBA, EBOOT, LBOOT, CLK IN, RESET, TCK.

⁴Applies to input pins with internal pull-ups: DRO, DR1, TRST, TM S, TD I.

⁵Applies to three-statable pins: DATA₄₇₋₀, ADDR₃₁₋₀, MS₃₋₀, RD, WR, PAGE, ADRCLK, SW, ACK, FLAG₃₋₀, REDY, HBG, DMAG1, DMAG2, BMS, BR₆₋₁, TFS_x, RFS_x, T D O, EMU. (Note that ACK is pulled up internally with 2 kΩ during reset in a multiprocessor system, when ID₂₋₀ = 001 and another ADSP-21062 is not requesting bus mastership.)

⁶Applies to three-statable pins with internal pull-ups: D T O, D T 1, TCLK0, TCLK1, RCLK0, RCLK1.

⁷Applies to CPA pin.

⁸Applies to ACK pin when pulled up. (Note that ACK is pulled up internally with 2 kΩ during reset in a multiprocessor system, when ID₂₋₀ = 001 and another ADSP-21060LC is not requesting bus mastership.)

⁹Applies to three-statable pins with internal pull-downs: LxDAT₃₋₀, LxCLK, LxACK.

¹⁰Applies to ACK pin when keeper latch enabled.

¹¹Applies to all signal pins.

¹²Guaranteed but not tested.

Specifications subject to change without notice.

ADSP-21060C/ADSP-21060LC

POWER DISSIPATION ADSP-21060LC (3.3 V)

These specifications apply to the internal power portion of V_{DD} only. See the Power Dissipation section of this data sheet for calculation of external supply current and total supply current. For a complete discussion of the code used to measure power dissipation, see the technical note "SHARC Power Dissipation Measurements."

Specifications are based on the following operating scenarios:

Operation	Peak Activity ($I_{DDINPEAK}$)	High Activity ($I_{DDINHIGH}$)	Low Activity ($I_{DDINLOW}$)
Instruction Type	Multifunction	Multifunction	Single Function
Instruction Fetch	Cache	Internal Memory	Internal Memory
Core Memory Access	2 per Cycle (DM and PM)	1 per Cycle (DM)	None
Internal Memory DMA	1 per Cycle	1 per 2 Cycles	1 per 2 Cycles

To estimate power consumption for a specific application, use the following equation where % is the amount of time your program spends in that state:

$$\% PEAK \times I_{DDINPEAK} + \% HIGH \times I_{DDINHIGH} + \% LOW \times I_{DDINLOW} + \% IDLE \times I_{DDIDLE} = \text{power consumption}$$

Parameter	Test Conditions	Max	Units
$I_{DDINPEAK}$ Supply Current (Internal) ¹	$t_{CK} = 30 \text{ ns}, V_{DD} = \text{max},$	540	mA
	$t_{CK} = 25 \text{ ns}, V_{DD} = \text{max},$	600	mA
$I_{DDINHIGH}$ Supply Current (Internal) ²	$t_{CK} = 30 \text{ ns}, V_{DD} = \text{max},$	425	mA
	$t_{CK} = 25 \text{ ns}, V_{DD} = \text{max},$	475	mA
$I_{DDINLOW}$ Supply Current (Internal) ²	$t_{CK} = 30 \text{ ns}, V_{DD} = \text{max},$	250	mA
	$t_{CK} = 25 \text{ ns}, V_{DD} = \text{max},$	275	mA
I_{DDIDLE} Supply Current (Idle) ³	$V_{DD} = \text{max}$	180	mA

NOTES

¹The test program used to measure $I_{DDINPEAK}$ represents worst case processor operation and is not sustainable under normal application conditions. Actual internal power measurements made using typical applications are less than specified.

² $I_{DDINHIGH}$ is a composite average based on a range of high activity code. $I_{DDINLOW}$ is a composite average based on a range of low activity code.

³Idle denotes ADSP-21060LC state during execution of IDLE instruction.

ABSOLUTE MAXIMUM RATINGS (5 V)*

Supply Voltage -0.3 V to +7 V
Input Voltage -0.5 V to $V_{DD} + 0.5$ V
Output Voltage Swing -0.5 V to $V_{DD} + 0.5$ V
Load Capacitance 200 pF
Junction Temperature Under Bias 130°C
Storage Temperature Range -65°C to +150°C
Lead Temperature (5 seconds) +280°C

*Stresses greater than those listed above may cause permanent damage to the device. These are stress ratings only, and functional operation of the device at these or any other conditions greater than those indicated in the operational sections of this specification is not implied. Exposure to absolute maximum rating conditions for extended periods may affect device reliability.

ABSOLUTE MAXIMUM RATINGS (3.3 V)*

Supply Voltage -0.3 V to +4.6 V
Input Voltage -0.5 V to $V_{DD} + 0.5$ V
Output Voltage Swing -0.5 V to $V_{DD} + 0.5$ V
Load Capacitance 200 pF
Junction Temperature Under Bias 130°C
Storage Temperature Range -65°C to +150°C
Lead Temperature (5 seconds) +280°C

*Stresses greater than those listed above may cause permanent damage to the device. These are stress ratings only, and functional operation of the device at these or any other conditions greater than those indicated in the operational sections of this specification is not implied. Exposure to absolute maximum rating conditions for extended periods may affect device reliability.

ESD SENSITIVITY

The AD SP-2106x processors are ESD (electrostatic discharge) sensitive devices. Electrostatic charges readily accumulate on the human body and equipment and can discharge without detection. Permanent damage may occur to devices subjected to high energy electrostatic discharges.

The AD SP-2106x processors include proprietary ESD protection circuitry to dissipate high energy discharges. Per method 3015 of MIL-STD-883, the AD SP-2106x processors have been classified as a Class 2 device.

Proper ESD precautions are recommended to avoid performance degradation or loss of functionality. Unused devices must be stored in conductive foam or shunts, and the foam should be discharged to the destination socket before devices are removed.



TIMING SPECIFICATIONS

Two speed grades of the AD SP-21060C are offered, 40 MHz and 33.3 MHz. The specifications shown are based on a CLK IN frequency of 40 MHz ($t_{CK} = 25$ ns). The D T derating allows specifications at other CLK IN frequencies (within the min-max range of the t_{CK} specification; see Clock Input below). D T is the difference between the actual CLK IN period and a CLK IN period of 25 ns:

$$DT = t_{CK} - 25 \text{ ns}$$

Use the exact timing information given. Do not attempt to derive parameters from the addition or subtraction of others. While addition or subtraction would yield meaningful results for an individual device, the values given in this data sheet reflect statistical variations and worst cases. Consequently, you cannot meaningfully add parameters to derive longer times.

See Figure 28 under Test Conditions for voltage reference levels.

Switching Characteristics specify how the processor changes its signals. You have no control over this timing—circuitry external to the processor must be designed for compatibility with these signal characteristics. Switching characteristics tell you what the processor will do in a given circumstance. You can also use switching characteristics to ensure that any timing requirement of a device connected to the processor (such as memory) is satisfied.

Timing Requirements apply to signals that are controlled by circuitry external to the processor, such as the data input for a read operation. Timing requirements guarantee that the processor operates correctly with other devices.

(O D) = Open Drain
(A D) = Active Drive

ADSP-21060C/ADSP-21060LC

Parameter	ADSP-21060C				ADSP-21060LC				Units		
	40 MHz		33 MHz		40 MHz		33 MHz				
	Min	Max	Min	Max	Min	Max	Min	Max			
Clock Input											
<i>Timing Requirements:</i>											
t_{CK}	CLK IN Period		25	100	30	100	25	100	30	100	ns
t_{CKL}	CLK IN Width Low		7		7		8.75		8.75		ns
t_{CKH}	CLK IN Width High		5		5		5		5		ns
t_{CKRF}	CLK IN Rise/Fall (0.4 V–2.0 V)			3		3		3		3	ns

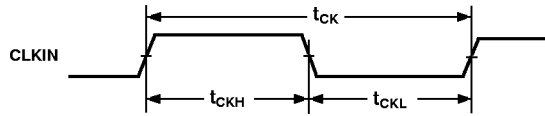

Figure 8. Clock Input

Parameter	ADSP-21060C		ADSP-21060LC		Units		
	Min	Max	Min	Max			
Reset							
<i>Timing Requirements:</i>							
t_{WRST}	\overline{RESET} Pulse width Low ¹		$4t_{CK}$		$4t_{CK}$	ns	
t_{SRST}	\overline{RESET} Setup before CLK IN High ²		$14 + DT/2$	t_{CK}	$14 + DT/2$	t_{CK}	ns

NOTES

¹Applies after the power-up sequence is complete. At power-up, the processor's internal phase-locked loop requires no more than 2000 CLK IN cycles while RESET is low, assuming stable V_{DD} and CLK IN (not including start-up time of external clock oscillator).

²Only required if multiple ADSP-21060s must come out of reset synchronous to CLK IN with program counters (PC) equal (i.e., for a SIMD system). Not required for multiple ADSP-21060s communicating over the shared bus (through the external port), because the bus arbitration logic synchronizes itself automatically after reset.

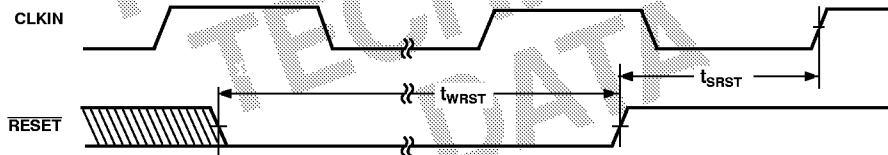

Figure 9. Reset

Parameter	ADSP-21060C		ADSP-21060LC		Units	
	Min	Max	Min	Max		
Interrupts						
<i>Timing Requirements:</i>						
t_{SIR}	$\overline{IRQ2-0}$ Setup before CLK IN High ¹		$18 + 3DT/4$		$18 + 3DT/4$	ns
t_{HIR}	$\overline{IRQ2-0}$ Hold before CLK IN High ¹			$12 + 3DT/4$	$12 + 3DT/4$	ns
t_{IPW}	$\overline{IRQ2-0}$ Pulse width ²		$2 + t_{CK}$		$2 + t_{CK}$	ns

NOTES

¹Only required for \overline{IRQx} recognition in the following cycle.

²Applies only if t_{SIR} and t_{HIR} requirements are not met.

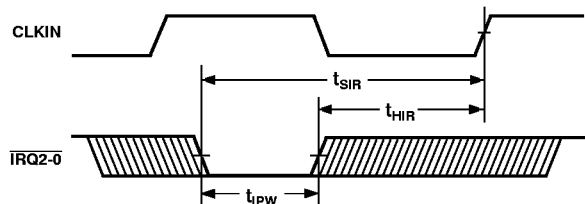

Figure 10. Interrupts

ADSP-21060C/ADSP-21060LC

Parameter	ADSP-21060C		ADSP-21060LC		Units
	Min	Max	Min	Max	
Timer					
<i>Switching Characteristic:</i>					
t_{DTEX} CLK IN High to TIM EXP		15		15	ns

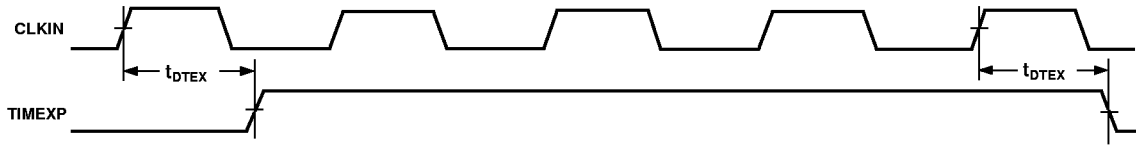

Figure 11. Timer

Parameter	ADSP-21060C		ADSP-21060LC		Units
	Min	Max	Min	Max	
Flags					
<i>Timing Requirements:</i>					
t_{SFI} FLAG 3-0 _{IN} Setup before CLK IN High ¹		$8 + 5D T / 16$		$8 + 5D T / 16$	ns
t_{HFI} FLAG 3-0 _{IN} Hold after CLK IN High ¹		$0 - 5D T / 16$		$0 - 5D T / 16$	ns
t_{DWRFI} FLAG 3-0 _{IN} Delay after $\overline{RD}/\overline{WR}$ Low ¹		$5 + 7D T / 16$		$5 + 7D T / 16$	ns
t_{HFWR} FLAG 3-0 _{IN} Hold after $\overline{RD}/\overline{WR}$ Deasserted ¹		0		0	ns
<i>Switching Characteristics:</i>					
t_{DFO} FLAG 3-0 _{OUT} Delay after CLK IN High		16		16	ns
t_{HFO} FLAG 3-0 _{OUT} Hold after CLK IN High		4		4	ns
t_{DFOE} CLK IN High to FLAG 3-0 _{OUT} Enable		3		3	ns
t_{DFOD} CLK IN High to FLAG 3-0 _{OUT} Disable		14		14	ns

NOTE

¹Flag inputs meeting these setup and hold times will affect conditional instructions in the following instruction cycle.

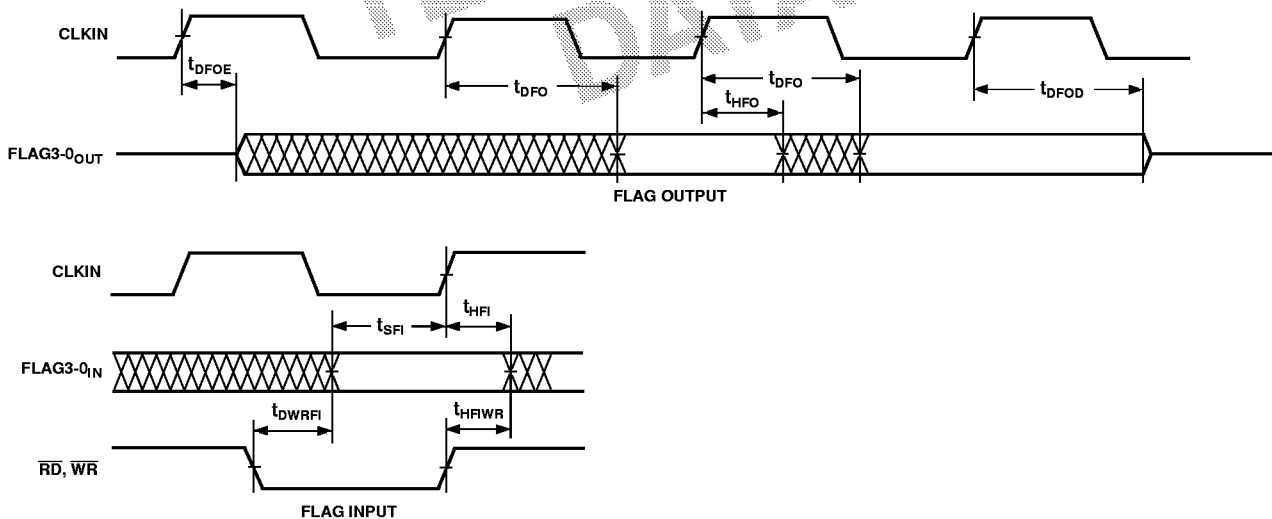

Figure 12. Flags

ADSP-21060C/ADSP-21060LC

Memory Read—Bus Master

Use these specifications for asynchronous interfacing to memories (and memory-mapped peripherals) without reference to CLKIN. These specifications apply when the ADSP-2106x is the bus master accessing external memory space. These switching

characteristics also apply for bus master synchronous read/write timing (see Synchronous Read/Write - Bus Master below). If these timing requirements are met, the synchronous read/write timing can be ignored (and vice versa).

Parameter	ADSP-21060C		ADSP-21060LC		Units
	Min	Max	Min	Max	
Timing Requirements:					
t_{DAD} Address, Selects Delay to Data Valid ^{1,2}		$18 + DT + W$		$18 + DT + W$	ns
t_{DRLD} \overline{RD} Low to Data Valid ¹		$12 + 5DT/\beta + W$		$12 + 5DT/\beta + W$	ns
t_{HDA} Data Hold from Address, Selects ³	0.5		0.5		ns
t_{HDRH} Data Hold from \overline{RD} High ³	2.0		2.0		ns
t_{DAAK} ACK Delay from Address, Selects ^{2,4}		$14 + 7DT/\beta + W$		$14 + 7DT/\beta + W$	ns
t_{DSAK} ACK Delay from \overline{RD} Low ⁴		$8 + DT/2 + W$		$8 + DT/2 + W$	ns
Switching Characteristics:					
t_{DRHA} Address, Selects Hold after \overline{RD} High	$0 + H$		$0 + H$		ns
t_{DARL} Address, Selects to \overline{RD} Low ²	$2 + 3DT/\beta$		$2 + 3DT/\beta$		ns
t_{RW} \overline{RD} Pulsewidth	$12.5 + 5DT/\beta + W$		$12.5 + 5DT/\beta + W$		ns
t_{RWR} \overline{RD} High to \overline{WR} , \overline{RD} , \overline{DMAGx} Low	$8 + 3DT/\beta + HI$		$8 + 3DT/\beta + HI$		ns
t_{SADADC} Address, Selects Setup before \overline{ADRCLK} High ²	$0 + DT/4$		$0 + DT/4$		ns

W = (number of wait states specified in WAIT register) $\times t_{CK}$.

HI = t_{CK} (if an address hold cycle or bus idle cycle occurs, as specified in WAIT register; otherwise $HI = 0$).

H = t_{CK} (if an address hold cycle occurs as specified in WAIT register; otherwise $H = 0$).

NOTES

¹Data Delay/Setup: Use minimum meet t_{DAD} or t_{DRLD} or synchronous specification t_{SDAT} .

²The falling edge of \overline{MSx} , \overline{SW} , \overline{BMS} is referenced.

³Data Hold: Use minimum meet t_{HDA} or t_{HDRH} or synchronous specification t_{SDAT} . See *System Hold Time Calculation* under Test Conditions for the calculation of hold times given capacitive and dc loads.

⁴ACK Delay/Setup: Use minimum meet t_{DAAK} or t_{DSAK} or synchronous specification t_{SACK} for deassertion of ACK (Low), all three specifications must be met for assertion of ACK (High).

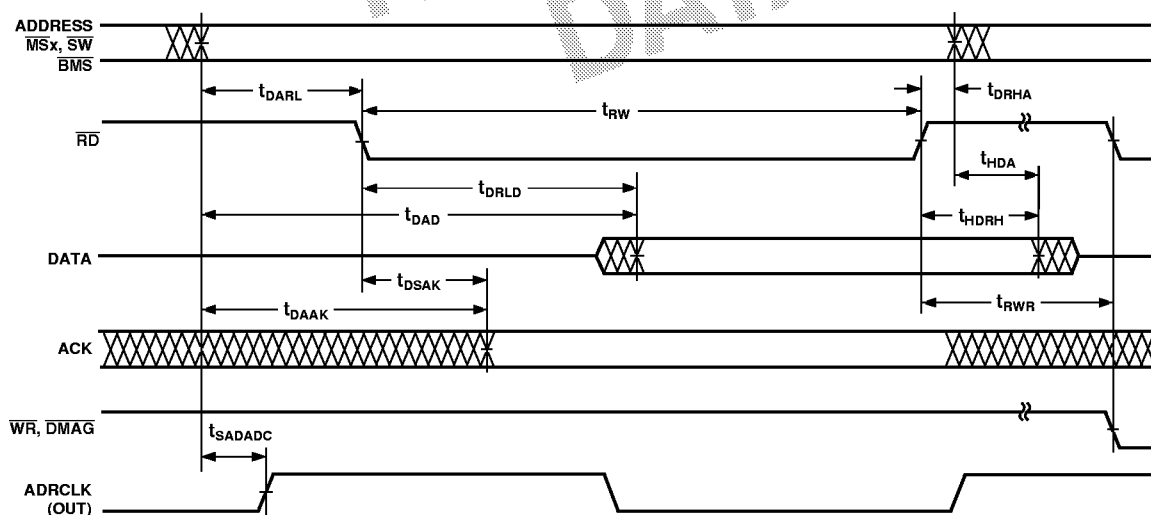

Figure 13. Memory Read—Bus Master

Memory Write—Bus Master

Use these specifications for asynchronous interfacing to memories (and memory-mapped peripherals) without reference to CLKIN. These specifications apply when the ADSP-2106x is the bus master accessing external memory space. These switching

characteristics also apply for bus master synchronous read/write timing (see Synchronous Read/Write—Bus Master). If these timing requirements are met, the synchronous read/write timing can be ignored (and vice versa).

Parameter	ADSP-21060C		ADSP-21060LC		Units
	Min	Max	Min	Max	
Timing Requirements:					
t_{DAAK} ACK Delay from Address, Selects ^{1,2}		$14 + 7DT/8 + W$		$14 + 7DT/8 + W$	ns
t_{DSAK} ACK Delay from \overline{WR} Low ¹		$8 + DT/2 + W$		$8 + DT/2 + W$	ns
Switching Characteristics:					
t_{DAWH} Address, Selects to \overline{WR} Deasserted ²	$17 + 15DT/16 + W$		$17 + 15DT/16 + W$		ns
t_{DAWL} Address, Selects to \overline{WR} Low ²	$3 + 3DT/8$		$3 + 3DT/8$		ns
t_{WW} \overline{WR} Pulse Width	$12 + 9DT/16 + W$		$12 + 9DT/16 + W$		ns
t_{DDWH} Data Setup before \overline{WR} High	$7 + DT/2 + W$		$7 + DT/2 + W$		ns
t_{DWHH} Address Hold after \overline{WR} Deasserted	$0.5 + DT/16 + H$		$0.5 + DT/16 + H$		ns
t_{DATRWH} Data Disable after \overline{WR} Deasserted ³	$1 + DT/16 + H$	$6 + DT/16 + H$	$1 + DT/16 + H$	$6 + DT/16 + H$	ns
t_{WWR} \overline{WR} High to \overline{WR} , \overline{RD} , \overline{DMAGx} Low	$8 + 7DT/16 + H$		$8 + 7DT/16 + H$		ns
t_{DDWR} Data Disable before \overline{WR} or \overline{RD} Low	$5 + 3DT/8 + I$		$5 + 3DT/8 + I$		ns
t_{WDE} \overline{WR} Low to Data Enabled	$-1 + DT/16$		$-1 + DT/16$		ns
t_{SADADC} Address, Selects to $\overline{ADRCCLK}$ High ²	$0 + DT/4$		$0 + DT/4$		ns

W = (number of wait states specified in WAIT register) $\times t_{CR}$.

H = t_{CR} (if an address hold cycle occurs, as specified in WAIT register; otherwise $H = 0$).

I = t_{CR} (if a bus idle cycle occurs, as specified in WAIT register; otherwise $I = 0$).

NOTES

¹ACK Delay/Setup: Use minimum of t_{DAAK} or t_{DSAK} or synchronous specification t_{SAACK} for deassertion of \overline{ACK} (Low), all three specifications must be met for assertion of \overline{ACK} (High).

²The falling edge of \overline{MSx} , \overline{SW} , \overline{BMS} is referenced.

³See *System Hold Time Calculation* under Test Conditions for calculation of hold times given capacitive and dc loads.

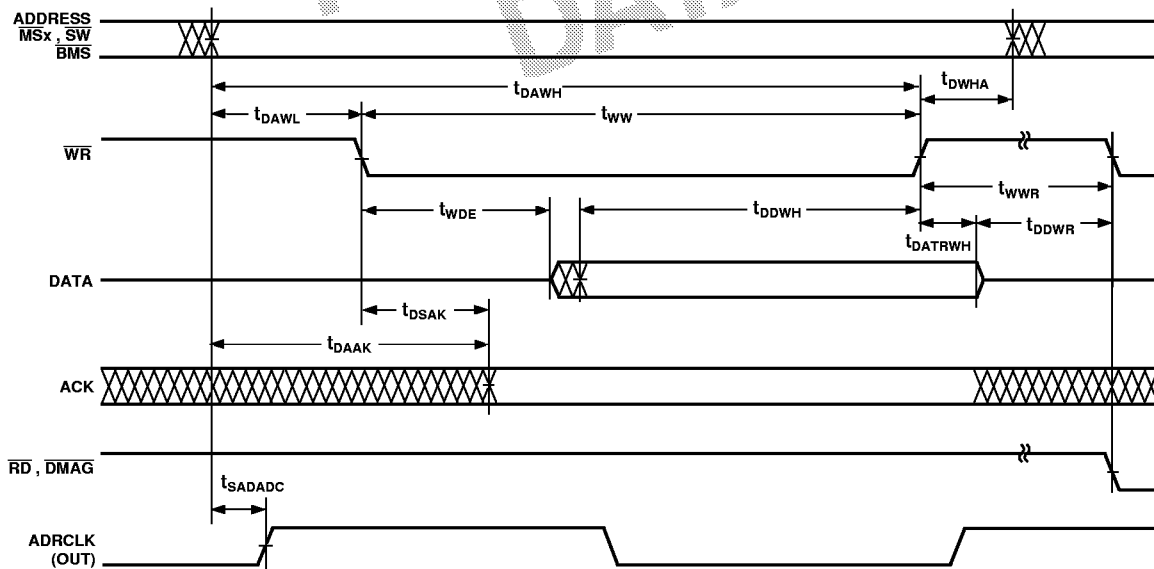

Figure 14. Memory Write—Bus Master

ADSP-21060C/ADSP-21060LC

Synchronous Read/Write—Bus Master

Use these specifications for interfacing to external memory systems that require CLK IN – relative timing or for accessing a slave ADSP-2106x (in multiprocessor memory space). These synchronous switching characteristics are also valid during asynchronous memory reads and writes (see Memory Read—Bus Master and Memory Write—Bus Master).

When accessing a slave ADSP-2106x, these switching characteristics must meet the slave's timing requirements for synchronous read/writes (see Synchronous Read/Write—Bus Slave). The slave ADSP-2106x must also meet these (bus master) timing requirements for data and acknowledge setup and hold times.

Parameter	ADSP-21060C		ADSP-21060LC		Units
	Min	Max	Min	Max	
Timing Requirements:					
t_{SDATI} Data Setup before CLK IN	$3 + DT/8$		$3 + DT/8$		ns
t_{HSDATI} Data Hold after CLK IN	$3.5 - DT/8$		$3.5 - DT/8$		ns
t_{DAK} ACK Delay after Address, \overline{MS}_x , \overline{SW} , \overline{BMS} ^{1,2}		$14 + 7DT/8 + W$		$14 + 7DT/8 + W$	ns
t_{SACK} ACK Setup before CLK IN ²	$6.5 + DT/4$		$6.5 + DT/4$		ns
t_{HACK} ACK Hold after CLK IN	$-1 - DT/4$		$-1 - DT/4$		ns
Switching Characteristics:					
t_{DADRO} Address, \overline{MS}_x , \overline{BMS} , \overline{SW} Delay after CLK IN ¹		$7 - DT/8$		$7 - DT/8$	ns
t_{HADRO} Address, \overline{MS}_x , \overline{BMS} , \overline{SW} Hold after CLK IN	$-1 - DT/8$		$-1 - DT/8$		ns
t_{DPG} PAGE Delay after CLK IN	$9 + DT/8$	$16 + DT/8$	$9 + DT/8$	$16 + DT/8$	ns
t_{DRDO} \overline{RD} High Delay after CLK IN	$-2 - DT/8$	$4 - DT/8$	$-2 - DT/8$	$4 - DT/8$	ns
t_{DWRO} \overline{WR} High Delay after CLK IN	$-3 - 3DT/16$	$4 - 3DT/16$	$-3 - 3DT/16$	$4 - 3DT/16$	ns
t_{DRWL} $\overline{RD}/\overline{WR}$ Low Delay after CLK IN	$8 + DT/4$	$12.5 + DT/4$	$8 + DT/4$	$12.5 + DT/4$	ns
t_{DDATO} Data Delay after CLK IN		$19 + 5DT/16$		$19 + 5DT/16$	ns
t_{DATR} Data Disable after CLK IN ³	$0 - DT/8$	$7 - DT/8$	$0 - DT/8$	$7 - DT/8$	ns
t_{DADCK} ADDRCLK Delay after CLK IN	$4 + DT/8$	$10 + DT/8$	$4 + DT/8$	$10 + DT/8$	ns
t_{ADRCK} ADDRCLK Period	t_{CK}		t_{CK}		ns
t_{ADRCKH} ADDRCLK Width High	$(t_{CK}/2 - 2)$		$(t_{CK}/2 - 2)$		ns
t_{ADRCKL} ADDRCLK Width Low	$(t_{CK}/2 - 2)$		$(t_{CK}/2 - 2)$		ns

$W = (\text{number of wait states specified in WAIT register}) \times t_{CK}$.

NOTES

¹The falling edge of \overline{MS}_x , \overline{SW} , \overline{BMS} is referenced.

²ACK Delay/Setup: User must meet t_{DAK} or t_{SAK} or synchronous specification t_{SACK} for deassertion of ACK (Low), all three specifications must be met for assertion of ACK (High).

³See **System Hold Time Calculation** under Test Conditions for calculation of hold times given capacitive and dc loads.

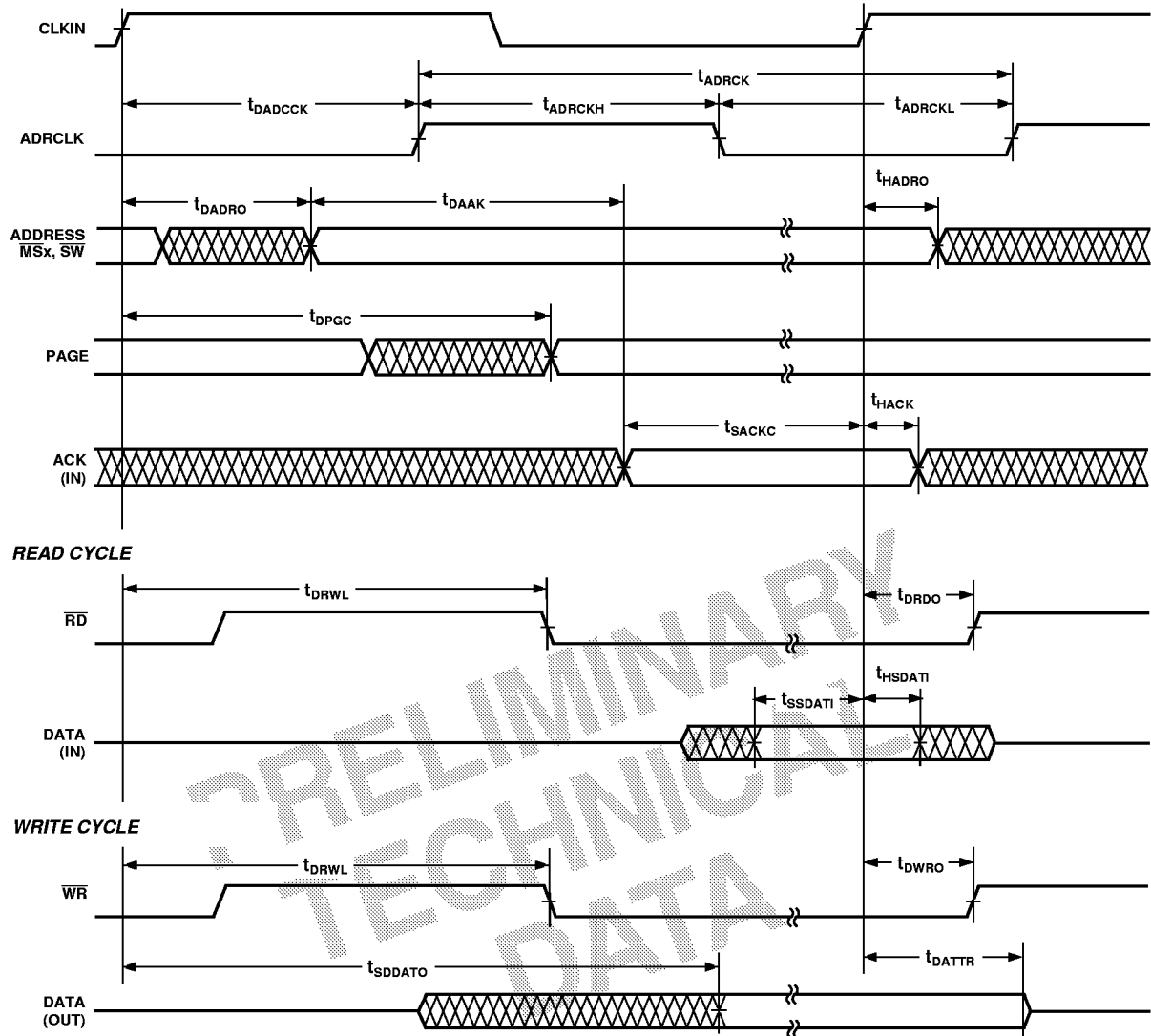

Figure 15. Synchronous Read/Write—Bus Master

ADSP-21060C/ADSP-21060LC

Synchronous Read/Write—Bus Slave

Use these specifications for ADSP-2106x bus master accesses of a slave's IOP registers or internal memory (in multiprocessor

memory space). The bus master must meet these (bus slave) timing requirements.

Parameter	ADSP-21060C		ADSP-21060LC		Units
	Min	Max	Min	Max	
Timing Requirements:					
t_{SADR1} Address, \overline{SW} Setup before CLK IN	$15 + DT/2$		$15 + DT/2$		ns
t_{HADRI} Address, \overline{SW} Hold before CLK IN		$5 + DT/2$		$5 + DT/2$	ns
t_{SRWLI} $\overline{RD}/\overline{WR}$ Low Setup before CLK IN ¹	$9.5 + 5DT/16$		$9.5 + 5DT/16$		ns
t_{HRWLI} $\overline{RD}/\overline{WR}$ Low Hold after CLK IN	$-4 - 5DT/16$	$8 + 7DT/16$	$-4 - 5DT/16$	$8 + 7DT/16$	ns
t_{RWHPI} $\overline{RD}/\overline{WR}$ Pulse High	3		3		ns
t_{SDATWH} Data Setup before \overline{WR} High	5		5		ns
t_{HDATWH} Data Hold after \overline{WR} High	1		1		ns
Switching Characteristics:					
t_{SDDATO} Data Delay after CLK IN		$19 + 5DT/16$		$19 + 5DT/16$	ns
t_{DATTR} Data Disable after CLK IN ²	$0 - DT/8$	$7 - DT/8$	$0 - DT/8$	$7 - DT/8$	ns
t_{DACKAD} ACK Delay after Address, \overline{SW} ³		9		9	ns
t_{ACKTR} ACK Disable after CLK IN ³	$-1 - DT/8$	$6 - DT/8$	$-1 - DT/8$	$6 - DT/8$	ns

NOTES

¹ t_{SRWLI} (n in) = $9.5 + 5DT/16$ when Multiprocessor Memory Space Wait State (MMSWSEL in WAIT register) is disabled; when MMSWSEL is enabled, t_{SRWLI} (n in) = $4 + DT/8$.

²See **System Hold Time Calculation** under Test Conditions for calculation of hold times given capacitance and dc loads.

³ t_{DACKAD} is true only if the address and \overline{SW} inputs have setup times (before CLK IN) greater than $10 + DT/8$ and less than $19 + 3DT/4$. If the address and \overline{SW} inputs have setup times greater than $19 + 3DT/4$, then ACK is valid $14 + DT/4$ (n ax) after CLK IN. A slave that sees an address with an M field match will respond with ACK regardless of the state of MMSWSEL or strobes. A slave will tristate ACK every cycle with t_{ACKTR} .

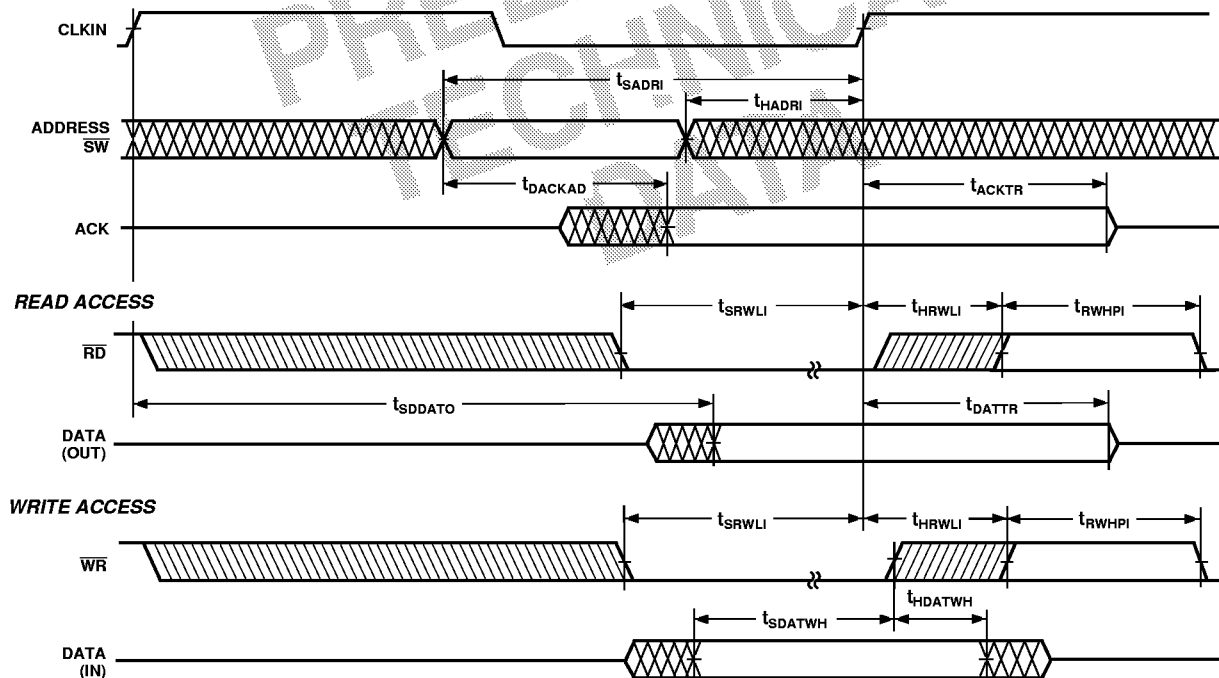

Figure 16. Synchronous Read/Write—Bus Slave

Multiprocessor Bus Request and Host Bus Request

Use these specifications for passing of bus mastership between multiprocessor ADSP-2106xs ($\overline{\text{BRx}}$) or a host processor ($\overline{\text{HBR}}$, $\overline{\text{HBG}}$).

Parameter	ADSP-21060C		ADSP-21060LC		Units
	Min	Max	Min	Max	
<i>Timing Requirements</i>					
t_{HBGRCSV} $\overline{\text{HBG}}$ Low to $\overline{\text{RD}}/\overline{\text{WR}}/\overline{\text{CS}}$ Valid ¹		20 + 5DT/4		20 + 5DT/4	ns
t_{SHBRI} $\overline{\text{HBR}}$ Setup before CLK IN ²	20 + 3DT/4		20 + 3DT/4		ns
t_{HHBRI} $\overline{\text{HBR}}$ Hold before CLK IN ²		14 + 3DT/4		14 + 3DT/4	ns
t_{SHBGI} $\overline{\text{HBG}}$ Setup before CLK IN	13 + DT/2		13 + DT/2		ns
t_{HHBGI} $\overline{\text{HBG}}$ Hold before CLK IN High		6 + DT/2		6 + DT/2	ns
t_{SBRI} $\overline{\text{BRx}}$, $\overline{\text{CPA}}$ Setup before CLK IN ³	13 + DT/2		13 + DT/2		ns
t_{HBRI} $\overline{\text{BRx}}$, $\overline{\text{CPA}}$ Hold before CLK IN High		6 + DT/2		6 + DT/2	ns
t_{SRPBAI} RPBA Setup before CLK IN	21 + 3DT/4		21 + 3DT/4		ns
t_{HRPBAI} RPBA Hold before CLK IN		12 + 3DT/4		12 + 3DT/4	ns
<i>Switching Characteristics</i>					
t_{DHBGO} $\overline{\text{HBG}}$ Delay after CLK IN		7 - DT/8		7 - DT/8	ns
t_{HHBGO} $\overline{\text{HBG}}$ Hold after CLK IN	-2 - DT/8		-2 - DT/8		ns
t_{DBRO} $\overline{\text{BRx}}$ Delay after CLK IN		7 - DT/8		7 - DT/8	ns
t_{HBRHO} $\overline{\text{BRx}}$ Hold after CLK IN	-2 - DT/8		-2 - DT/8		ns
t_{DCPAO} $\overline{\text{CPA}}$ Low Delay after CLK IN		8 - DT/8		8 - DT/8	ns
t_{TRCPA} $\overline{\text{CPA}}$ Disable after CLK IN	-2 - DT/8	4.5 - DT/8	-2 - DT/8	4.5 - DT/8	ns
t_{DRDYCS} REDY (O/D) or (A/D) Low from $\overline{\text{CS}}$ and $\overline{\text{HBR}}$ Low ⁴		8.5		9.25	ns
t_{TRDYHG} REDY (O/D) Disable or REDY (A/D) High from $\overline{\text{HBG}}$ ⁴	44 + 23DT/16		44 + 23DT/16		ns
t_{ARDYTR} REDY (A/D) Disable from $\overline{\text{CS}}$ or $\overline{\text{HBR}}$ High ⁴		10		10	ns

NOTES

¹For first asynchronous access after $\overline{\text{HBR}}$ and $\overline{\text{CS}}$ asserted, ADDRESS_{31:0} must be a non-MEM5 value 1/2 t_{ST} before $\overline{\text{RD}}$ or $\overline{\text{WR}}$ goes low or by t_{HBGRCSV} after $\overline{\text{HBG}}$ goes low. This is easily accomplished by driving an upper address signal high when $\overline{\text{HBG}}$ is asserted. See the "Host Processor Control of the ADSP-2106x" section in the *ADSP-2106x SHARC User's Manual, Second Edition*.

²Only required for recognition in the current cycle.

³ $\overline{\text{CPA}}$ assertion must meet the setup to CLK IN; deassertion does not need to meet the setup to CLK IN.

⁴(O/D) = open drain, (A/D) = active drive.

ADSP-21060C/ADSP-21060LC

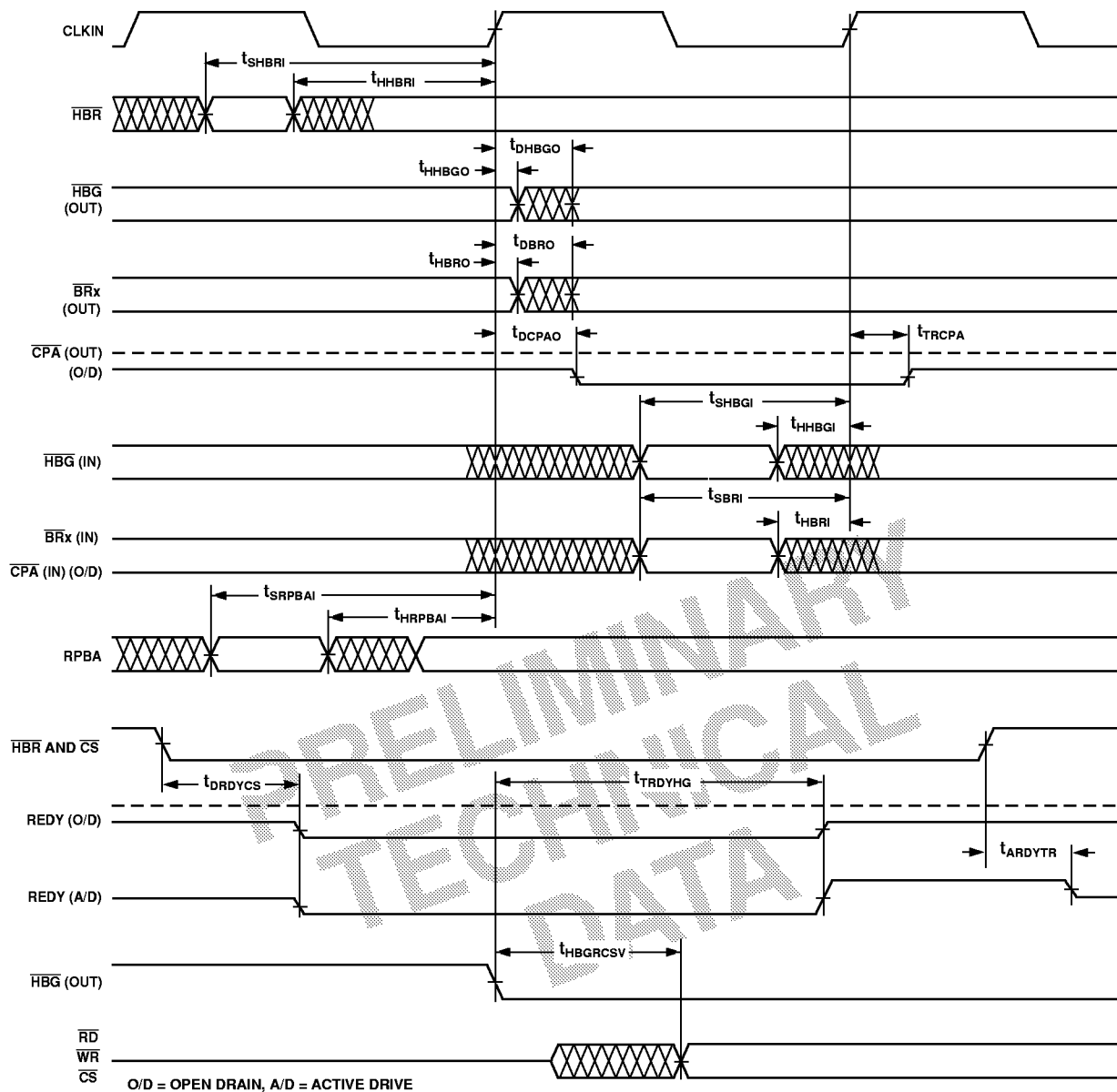

Figure 17. Multiprocessor Bus Request and Host Bus Request

Asynchronous Read/Write—Host to ADSP-2106x

Use these specifications for asynchronous host processor accesses of an ADSP-2106x, after the host has asserted \overline{CS} and \overline{HBR} (low). After \overline{HBG} is returned by the ADSP-2106x, the host can

drive the \overline{RD} and \overline{WR} pins to access the ADSP-2106x's internal memory or IOP registers. \overline{HBR} and \overline{HBG} are assumed low for this timing.

Parameter	ADSP-21060C		ADSP-21060LC		Units
	Min	Max	Min	Max	
Read Cycle					
<i>Timing Requirements</i>					
t_{SADRDL}	Address Setup \overline{CS} Low before \overline{RD} Low ¹		0	0	ns
t_{HADRDL}	Address Hold \overline{CS} Hold Low after \overline{RD}		0	0	ns
t_{WRWH}	$\overline{RD}/\overline{WR}$ High Width		6	6	ns
$t_{DRDHRDY}$	\overline{RD} High Delay after REDY (O/D) Disable		0	0	ns
$t_{DRDHRDY}$	\overline{RD} High Delay after REDY (A/D) Disable		0	0	ns
<i>Switching Characteristics</i>					
$t_{SDATRDY}$	Data Valid before REDY Disable from Low		2	2	ns
$t_{DRDYRDL}$	REDY (O/D) or (A/D) Low Delay after \overline{RD} Low			10	ns
t_{RDYPRD}	REDY (O/D) or (A/D) Low Pulsewidth for Read		45 + 21DT/16	45 + 21DT/16	ns
t_{HDARWH}	Data Disable after \overline{RD} High		2	8.5	ns
Write Cycle					
<i>Timing Requirements</i>					
t_{SCSWRL}	\overline{CS} Low Setup before \overline{WR} Low		0	0	ns
t_{HCSWRH}	\overline{CS} Low Hold after \overline{WR} High		0	0	ns
t_{SADWRH}	Address Setup before \overline{WR} High		5	5	ns
t_{HADWRH}	Address Hold after \overline{WR} High		2	2	ns
t_{WWRLL}	\overline{WR} Low Width		7	7	ns
t_{WRWH}	$\overline{RD}/\overline{WR}$ High Width		6	6	ns
t_{WRHRDY}	\overline{WR} High Delay after REDY (O/D) or (A/D) Disable		0	0	ns
t_{SDATWH}	Data Setup before \overline{WR} High		5	5	ns
t_{HDATWH}	Data Hold after \overline{WR} High		1	1	ns
<i>Switching Characteristics</i>					
$t_{DRDYWRL}$	REDY (O/D) or (A/D) Low Delay after $\overline{WR}/\overline{CS}$ Low			10	ns
t_{RDYPCR}	REDY (O/D) or (A/D) Low Pulsewidth for Write		15 + 7DT/16	15 + 7DT/16	ns
t_{SRDYCK}	REDY (O/D) or (A/D) Disable to CLKIN		1 + 7DT/16	8 + 7DT/16	ns

NOTE

¹Not required if \overline{RD} and address are valid $t_{HBGRCSV}$ after \overline{HBG} goes low. For first access after \overline{HBR} asserted, $ADDR_{31-0}$ must be a non-MMS value $1/2 t_{CLK}$ before \overline{RD} or \overline{WR} goes low or by $t_{HBGRCSV}$ after \overline{HBG} goes low. This is easily accomplished by driving an upper address signal high when \overline{HBG} is asserted. See the "Host Processor Control of the ADSP-2106x" section in the *ADSP-2106x SHARC User's Manual, Second Edition*.

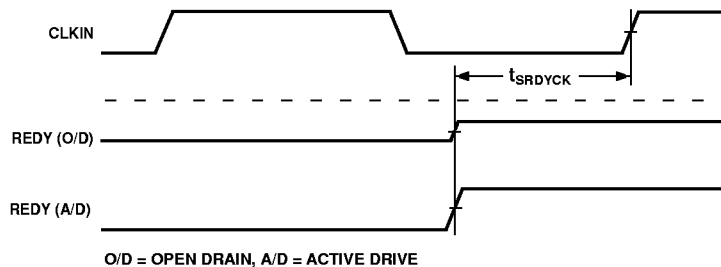

Figure 18a. Synchronous REDY Timing

ADSP-21060C/ADSP-21060LC

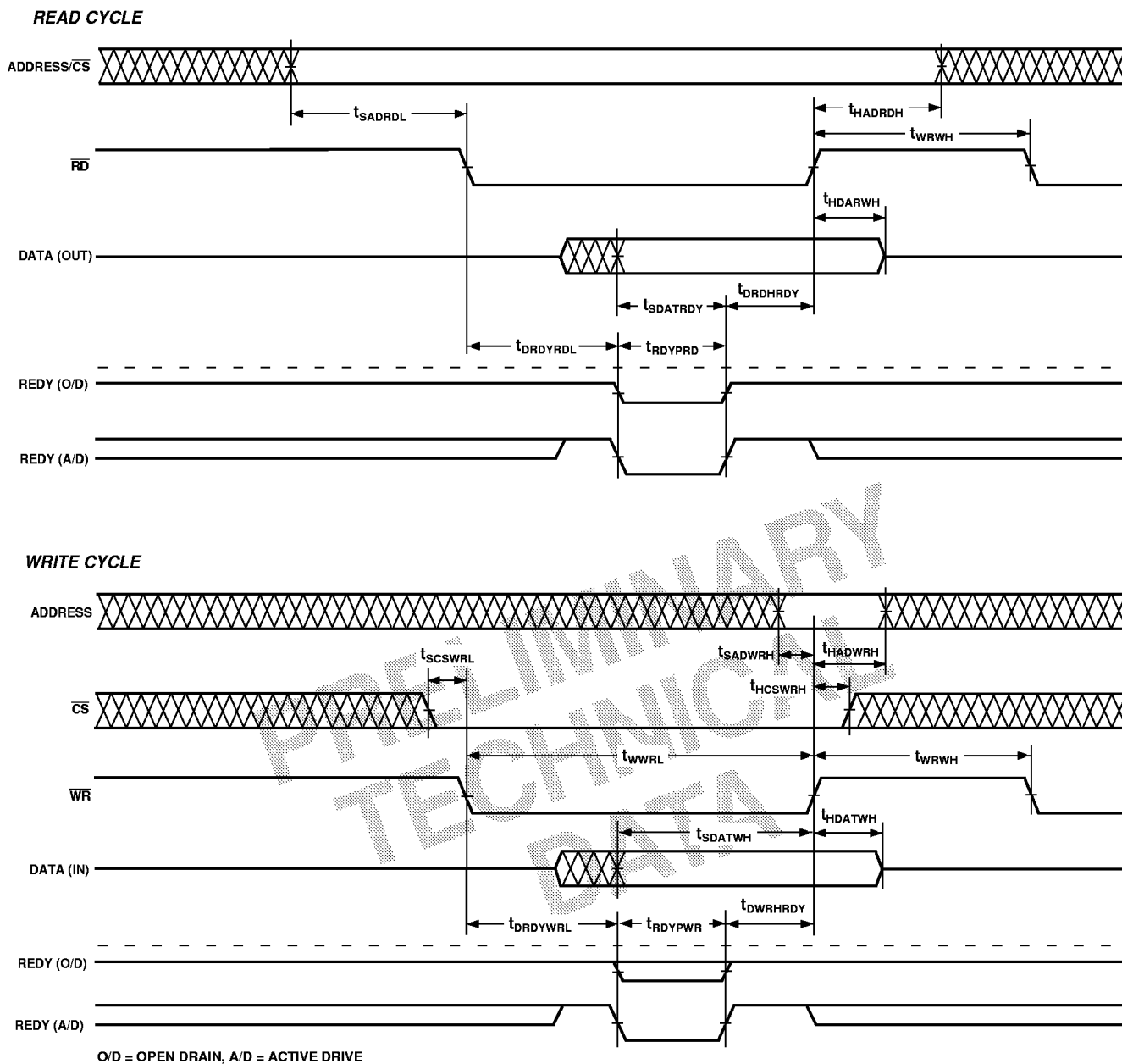

Figure 18b. Asynchronous Read/Write—Host to ADSP-2106x

Three-State Timing—Bus Master, Bus Slave, $\overline{\text{HBR}}$, $\overline{\text{SBTS}}$

These specifications show how the memory interface is disabled (stops driving) or enabled (resumes driving) relative to CLK IN

and the $\overline{\text{SBTS}}$ pin. This timing is applicable to bus master transition cycles (BTC) and host transition cycles (HTC) as well as the $\overline{\text{SBTS}}$ pin.

Parameter	ADSP-21060C		ADSP-21060LC		Units
	Min	Max	Min	Max	
Timing Requirements:					
t_{STSCk} $\overline{\text{SBTS}}$ Setup before CLK IN	$12 + DT/2$		$12 + DT/2$		ns
t_{HTSCk} $\overline{\text{SBTS}}$ Hold before CLK IN		$6 + DT/2$		$6 + DT/2$	ns
Switching Characteristics:					
t_{MIENA} Address/Select Enable after CLK IN	$-1.5 - DT/8$		$-1.25 - DT/8$		ns
t_{MIENS} Strobe Enable after CLK IN ¹	$-1.5 - DT/8$		$-1.5 - DT/8$		ns
t_{MIENHG} $\overline{\text{HBG}}$ Enable after CLK IN	$-1.5 - DT/8$		$-1.5 - DT/8$		ns
t_{MITRA} Address/Select Disable after CLK IN		$0 - DT/4$		$0 - DT/4$	ns
t_{MITRS} Strobe Disable after CLK IN ¹		$1.5 - DT/4$		$1.5 - DT/4$	ns
t_{MITRHG} $\overline{\text{HBG}}$ Disable after CLK IN		$2.0 - DT/4$		$2.0 - DT/4$	ns
t_{DATEN} Data Enable after CLK IN ²	$9 + 5DT/16$		$9 + 5DT/16$		ns
t_{DATTR} Data Disable after CLK IN ²	$0 - DT/8$	$7 - DT/8$	$0 - DT/8$	$7 - DT/8$	ns
t_{ACKEN} ACK Enable after CLK IN ²	$7.5 + DT/4$		$7.5 + DT/4$		ns
t_{ACKTR} ACK Disable after CLK IN ²	$-1 - DT/8$	$6 - DT/8$	$-1 - DT/8$	$6 - DT/8$	ns
t_{ADCEN} ADDRCLK Enable after CLK IN	$-2 - DT/8$		$-2 - DT/8$		ns
t_{ADCTR} ADDRCLK Disable after CLK IN		$8 - DT/4$		$8 - DT/4$	ns
t_{MTRHBG} Memory Interface Disable before $\overline{\text{HBG}}$ Low ³	$0 + DT/8$		$0 + DT/8$		ns
t_{MENHBG} Memory Interface Enable after $\overline{\text{HBG}}$ High ³	$19 + DT$		$19 + DT$		ns

NOTES

¹Strobes = $\overline{\text{RD}}$, $\overline{\text{WR}}$, $\overline{\text{SW}}$, $\overline{\text{PAGE}}$, $\overline{\text{DMAG}}$.

²In addition to bus master transition cycles, these specs also apply to bus master and bus slave synchronous read/write.

³Memory Interface = Address, $\overline{\text{RD}}$, $\overline{\text{WR}}$, $\overline{\text{MSx}}$, $\overline{\text{SW}}$, $\overline{\text{HBG}}$, $\overline{\text{PAGE}}$, $\overline{\text{DMAGx}}$, $\overline{\text{BMS}}$ (in EPROM boot mode).

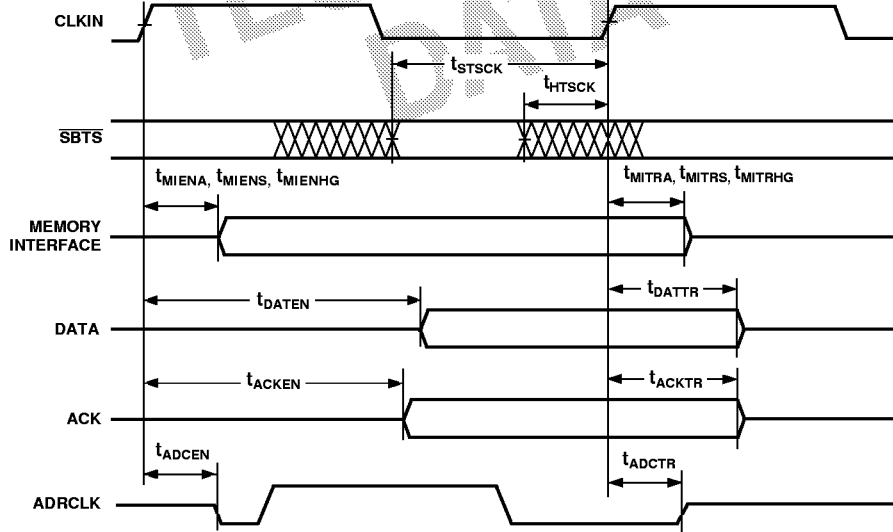
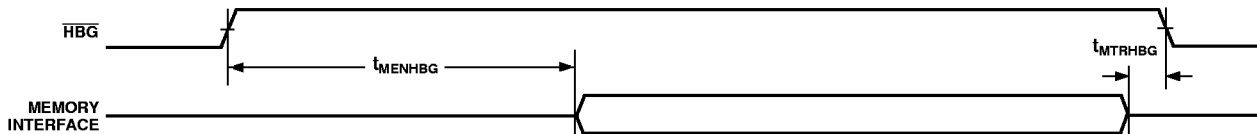

Figure 19a. Three-State Timing (Bus Transition Cycle, $\overline{\text{SBTS}}$ Assertion)



MEMORY INTERFACE = ADDRESS, $\overline{\text{RD}}$, $\overline{\text{WR}}$, $\overline{\text{MSx}}$, $\overline{\text{SW}}$, $\overline{\text{PAGE}}$, $\overline{\text{DMAGx}}$, $\overline{\text{BMS}}$ (IN EPROM BOOT MODE)

Figure 19b. Three-State Timing (Host Transition Cycle)

ADSP-21060C/ADSP-21060LC

DMA Handshake

These specifications describe the three DMA handshake modes. In all three modes \overline{DMAR} is used to initiate transfers. For handshake mode, \overline{DMAG} controls the latching or enabling of data externally. For external handshake mode, the data transfer is controlled by the \overline{ADDR}_{31-0} , \overline{RD} , \overline{WR} , \overline{SW} , \overline{PAGE} , \overline{MS}_{3-0} , \overline{ACK} , and \overline{DMAG} signals. For Paced Master mode, the data

transfer is controlled by \overline{ADDR}_{31-0} , \overline{RD} , \overline{WR} , \overline{MS}_{3-0} , and \overline{ACK} (not \overline{DMAG}). For Paced Master mode, the Memory Read-Bus Master, Memory Write-Bus Master, and Synchronous Read/Write-Bus Master timing specifications for \overline{ADDR}_{31-0} , \overline{RD} , \overline{WR} , \overline{MS}_{3-0} , \overline{SW} , \overline{PAGE} , \overline{DATA}_{47-0} , and \overline{ACK} also apply.

Parameter	ADSP-21060C		ADSP-21060LC		Units	
	Min	Max	Min	Max		
Timing Requirements:						
t_{SDRLC}	\overline{DMARx} Low Setup before \overline{CLKIN}^1	5	5		ns	
t_{SDRHC}	\overline{DMARx} High Setup before \overline{CLKIN}^1	5	5		ns	
t_{WDR}	\overline{DMARx} Width Low (Nonsynchronous)	6	6		ns	
$t_{SDATDGL}$	Data Setup after \overline{DMAGx} Low ²			$10 + 5DT/8$	ns	
$t_{HDATDGH}$	Data Hold after \overline{DMAGx} High	2	2		ns	
t_{DATDRH}	Data Valid after \overline{DMARx} High ²			$16 + 7DT/8$	ns	
t_{DMARLL}	\overline{DMARx} Low Edge to Low Edge	$23 + 7DT/8$	$23 + 7DT/8$		ns	
t_{DMARH}	\overline{DMARx} Width High	6	6		ns	
Switching Characteristics:						
t_{DGL}	\overline{DMAGx} Low Delay after \overline{CLKIN}	$9 + DT/4$	$15 + DT/4$	$9 + DT/4$	$15 + DT/4$	ns
t_{WDGH}	\overline{DMAGx} High Width	$6 + 3DT/8$		$6 + 3DT/8$		ns
t_{WDL}	\overline{DMAGx} Low Width	$12 + 5DT/8$		$12 + 5DT/8$		ns
t_{HDGC}	\overline{DMAGx} High Delay after \overline{CLKIN}	$-2 - DT/8$	$6 - DT/8$	$-2 - DT/8$	$6 - DT/8$	ns
$t_{VDATDGH}$	Data Valid before \overline{DMAGx} High ³	$8 + 9DT/16$		$8 + 9DT/16$		ns
$t_{DATDRGH}$	Data Disable after \overline{DMAGx} High	0	7	0	7	ns
t_{DWRLL}	\overline{WR} Low before \overline{DMAGx} Low	0	2	0	2	ns
t_{DWRH}	\overline{DMAGx} Low before \overline{WR} High	$10 + 5DT/8 + W$		$10 + 5DT/8 + W$		ns
t_{DWRR}	\overline{WR} High before \overline{DMAGx} High	$1 + DT/16$	$3 + DT/16$	$1 + DT/16$	$3 + DT/16$	ns
t_{DGRDL}	\overline{RD} Low before \overline{DMAGx} Low	0	2	0	2	ns
t_{DRDGH}	\overline{RD} Low before \overline{DMAGx} High	$11 + 9DT/16 + W$		$11 + 9DT/16 + W$		ns
t_{DGRDR}	\overline{RD} High before \overline{DMAGx} High	0	3	0	3	ns
t_{DGR}	\overline{DMAGx} High to \overline{WR} , \overline{RD} , \overline{DMAGx} Low	$5 + 3DT/8 + HI$		$5 + 3DT/8 + HI$		ns
t_{DADGH}	Address/Select Valid to \overline{DMAGx} High	$17 + DT$		$17 + DT$		ns
t_{DAGHA}	Address/Select Hold after \overline{DMAGx} High	-0.5		-0.5		ns

W = (number of wait states specified in \overline{WAIT} register) $\times t_{CR}$.

HI = t_{CR} (if an address hold cycle or bus idle cycle occurs, as specified in \overline{WAIT} register; otherwise $HI = 0$).

NOTES

¹Only required for recognition in the current cycle.

² $t_{SDATDGL}$ is the data setup requirement if \overline{DMARx} is not being used to hold off completion of a write. Otherwise, if \overline{DMARx} low holds off completion of the write, the data can be driven t_{DATDRH} after \overline{DMARx} is brought high.

³ $t_{VDATDGH}$ is valid if \overline{DMARx} is not being used to hold off completion of a read. If \overline{DMARx} is used to prolong the read, then $t_{VDATDGH} = 8 + 9DT/16 + (n \times t_{CR})$ where n equals the number of extra cycles that the access is prolonged.

⁴See **System Hold Time Calculation** under Test Conditions for calculation of hold times given capacitive and dc loads.

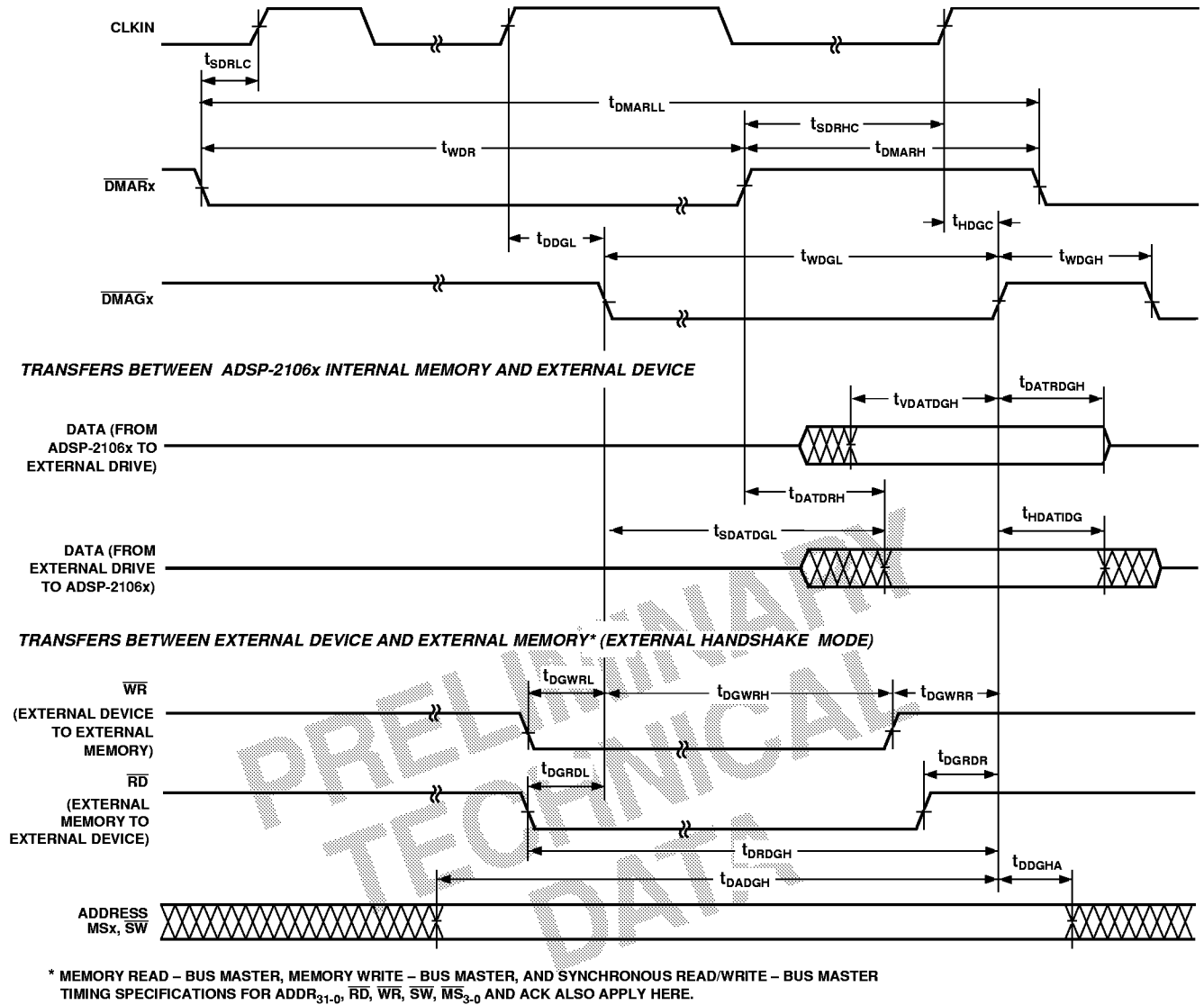

Figure 20. DMA Handshake Timing

ADSP-21060C/ADSP-21060LC

Link Ports: 1 × CLK Speed Operation

Parameter	ADSP-21060C		ADSP-21060LC		Units
	Min	Max	Min	Max	
Receive					
<i>Timing Requirements:</i>					
t_{SLDCL} Data Setup before LCLK Low	3.5		3		ns
t_{HLDCL} Data Hold after LCLK Low	3		3		ns
t_{LCLKW} LCLK Period (1 × Operation)	t_{CK}		t_{CK}		ns
$t_{LCLKRWL}$ LCLK Width Low	6		6		ns
$t_{LCLKRWH}$ LCLK Width High	5		5		ns
<i>Switching Characteristics:</i>					
t_{DLAC} LACK High Delay after CLK IN High	$18 + DT/2$	$28.5 + DT/2$	$18 + DT/2$	$28.5 + DT/2$	ns
t_{DLALC} LACK Low Delay after LCLK High ¹	-3	13	-3	13	ns
t_{ENDLK} LACK Enable from CLK IN	$5 + DT/2$		$5 + DT/2$		ns
t_{FDLK} LACK Disable from CLK IN		$20 + DT/2$		$20 + DT/2$	ns
Transmit					
<i>Timing Requirements:</i>					
t_{SLACH} LACK Setup before LCLK High	18		20		ns
t_{HLACH} LACK Hold after LCLK High	-7		7		ns
<i>Switching Characteristics:</i>					
t_{DLCK} LCLK Delay after CLK IN (1 × operation)		15.5		16.5	ns
t_{DLDC} Data Delay after LCLK High		3		2.5	ns
t_{HLDCH} Data Hold after LCLK High	-3		3		ns
$t_{LCLKTWL}$ LCLK Width Low	$(t_{CK}/2) - 2$	$(t_{CK}/2) + 2$	$(t_{CK}/2) - 1$	$(t_{CK}/2) + 1.25$	ns
$t_{LCLKTWH}$ LCLK Width High	$(t_{CK}/2) - 2$	$(t_{CK}/2) + 2$	$(t_{CK}/2) - 1.25$	$(t_{CK}/2) + 1.0$	ns
t_{DLACLK} LCLK Low Delay after LACK High	$(t_{CK}/2) + 8.5$	$(3 \times t_{CK}/2) + 17$	$(t_{CK}/2) + 8.0$	$(3 \times t_{CK}/2) + 17.5$	ns
t_{ENDLK} LDAT, LCLK Enable after CLK IN	$5 + DT/2$		$5 + DT/2$		ns
t_{FDLK} LDAT, LCLK Disable after CLK IN		$20 + DT/2$		$20 + DT/2$	ns
Link Port Service Request Interrupts: 1 × and 2 × Speed Operations					
<i>Timing Requirements:</i>					
t_{SLCK} LACK/LCLK Setup before CLK IN Low ²	10		10		ns
t_{HLCK} LACK/LCLK Hold after CLK IN Low ²	2		2		ns

NOTES

¹LACK will go low with t_{DLALC} relative to rising edge of LCLK after first nibble is received. LACK will not go low if the receiver's link buffer is not about to fill.

²Only required for interrupt recognition in the current cycle.

Link Ports: 2 × CLK Speed Operation

Calculation of link receiver data setup and hold relative to link clock is required to determine the maximum allowable skew that can be introduced in the transmission path between LDATA and LCLK. Setup skew is the maximum delay that can be introduced in LDATA relative to LCLK, (setup skew = $t_{CLKTWH\ min} - t_{LDCH} - t_{SDCL}$). Hold skew is the maximum delay that can be introduced in LCLK relative to LDATA, (hold skew = $t_{CLKTWH\ min} - t_{HLDCH} - t_{HLDCL}$). Calculations made directly from 2× speed specifications will result in unrealistically small skew times because they include multiple tester guardbands. The setup and hold skew times shown below are calculated to include only one tester guardband.

ADSP-21060C Setup Skew	= 1.93 nsec
ADSP-21060C Hold Skew	= 2.95 nsec
ADSP-21060LC Setup Skew	= 1.87 nsec
ADSP-21060LC Hold Skew	= 1.69 nsec

Parameter	ADSP-21060C		ADSP-21060LC		Units
	Min	Max	Min	Max	
Receive					
<i>Timing Requirements:</i>					
t_{SDCL} Data Setup before LCLK Low	2.5		2.25		ns
t_{HLDCL} Data Hold after LCLK Low	2.25		2.25		ns
t_{CLKW} LCLK Period (2 × Operation)	$t_{CK}/2$		$t_{CK}/2$		ns
t_{CLKRWL} LCLK Width Low	4.5		5.0		ns
t_{CLKRWH} LCLK Width High	4.25		4.0		ns
<i>Switching Characteristics:</i>					
t_{LAHC} LACK High Delay after CLK IN High	$18 + DT/2$	$28.5 + DT/2$	$18 + DT/2$	$29.5 + DT/2$	ns
t_{LALC} LACK Low Delay after LCLK High ¹	6	16	6	18	ns
Transmit					
<i>Timing Requirements:</i>					
t_{SLACH} LACK Setup before LCLK High	19		19		ns
t_{HLACH} LACK Hold after LCLK High	-6.75		-6.5		ns
<i>Switching Characteristics:</i>					
t_{LCLK} LCLK Delay after CLK IN		8		8	ns
t_{LDCH} Data Delay after LCLK High		2.5		2.25	ns
t_{HLDCH} Data Hold after LCLK High	-2.0		-2.0		ns
t_{CLKTWL} LCLK Width Low	$(t_{CK}/4) - 1$	$(t_{CK}/4) + 1$	$(t_{CK}/4) - 0.75$	$(t_{CK}/4) + 1.5$	ns
t_{CLKTWH} LCLK Width High	$(t_{CK}/4) - 1$	$(t_{CK}/4) + 1$	$(t_{CK}/4) - 1.5$	$(t_{CK}/4) + 1$	ns
t_{LACLK} LCLK Low Delay after LACK High	$(t_{CK}/4) + 9$	$(3 \cdot t_{CK}/4) + 16.5$	$(t_{CK}/4) + 9$	$(3 \cdot t_{CK}/4) + 16.5$	ns

NOTE

¹LACK will go low with t_{LALC} relative to rising edge of LCLK after first nibble is received. LACK will not go low if the receiver's link buffer is not about to fill.

ADSP-21060C/ADSP-21060LC

TRANSMIT

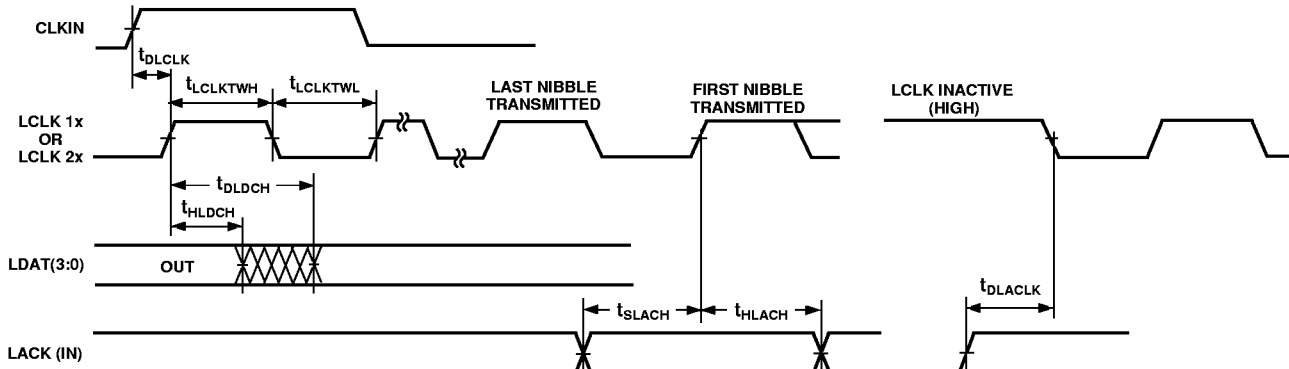

THE t_{SLACH} REQUIREMENT APPLIES TO THE RISING EDGE OF LCLK ONLY FOR THE FIRST NIBBLE TRANSMITTED.

RECEIVE

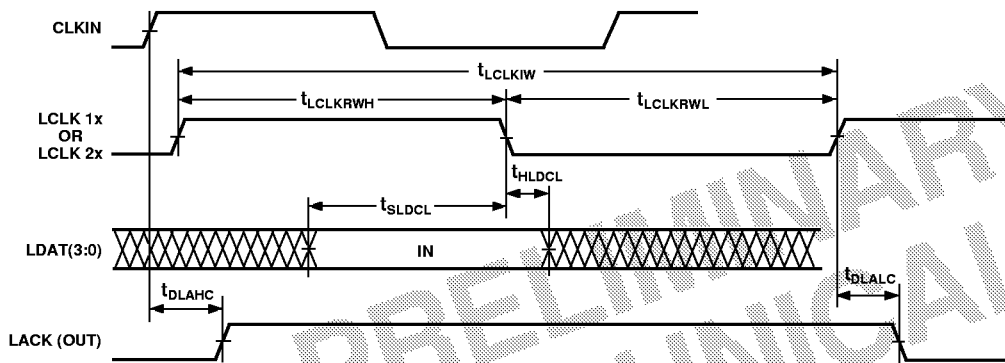

LINK PORT ENABLE/THREE-STATE DELAY FROM INSTRUCTION

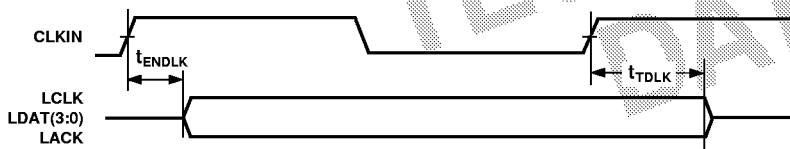

LINK PORT ENABLE OR THREE-STATE TAKES EFFECT 2 CYCLES AFTER A WRITE TO A LINK PORT CONTROL REGISTER.

LINK PORT INTERRUPT SETUP TIME

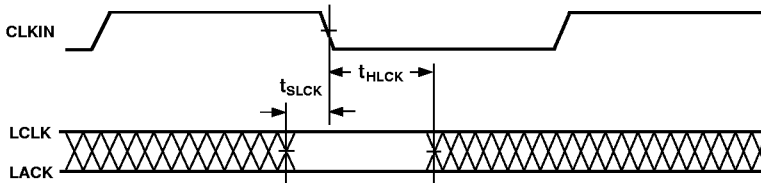

Figure 21. Link Ports

Serial Ports

Parameter	ADSP-21060C		ADSP-21060LC		Units
	Min	Max	Min	Max	
External Clock					
<i>Timing Requirements:</i>					
t_{SFSE}	TFS/RFS Setup before TCLK/RCLK ¹	3.5	3.5		ns
t_{HFSE}	TFS/RFS Hold after TCLK/RCLK ^{1,2}	4	4		ns
t_{SDRE}	Receive Data Setup before RCLK ¹	1.5	1.5		ns
t_{HDRE}	Receive Data Hold after RCLK ¹	4	4		ns
t_{SCLKW}	TCLK/RCLK Width	9.5	9.0		ns
t_{SCLK}	TCLK/RCLK Period	t_{CK}	t_{CK}		ns
Internal Clock					
<i>Timing Requirements:</i>					
t_{SFSI}	TFS Setup before TCLK ¹ ; RFS Setup before RCLK ¹	8	8		ns
t_{HFSI}	TFS/RFS Hold after TCLK/RCLK ^{1,2}	1	1		ns
t_{SDRI}	Receive Data Setup before RCLK ¹	3	3		ns
t_{HDRI}	Receive Data Hold after RCLK ¹	3	3		ns
External or Internal Clock					
<i>Switching Characteristics:</i>					
t_{DFSE}	RFS Delay after RCLK (Internally Generated RFS) ³		13	13	ns
t_{HOFSE}	RFS Hold after RCLK (Internally Generated RFS) ³	3	3		ns
External Clock					
<i>Switching Characteristics:</i>					
t_{DFSE}	TFS Delay after TCLK (Internally Generated TFS) ³		13	13	ns
t_{HOFSE}	TFS Hold after TCLK (Internally Generated TFS) ³	3	3		ns
t_{DDTE}	Transmit Data Delay after TCLK ³		16	16	ns
t_{HODTE}	Transmit Data Hold after TCLK ³	5	5		ns
Internal Clock					
<i>Switching Characteristics:</i>					
t_{DFSI}	TFS Delay after TCLK (Internally Generated TFS) ³		4.5	4.5	ns
t_{HOFSI}	TFS Hold after TCLK (Internally Generated TFS) ³	-1.5	-1.5		ns
t_{DDTI}	Transmit Data Delay after TCLK ³		7.5	7.5	ns
t_{HDTI}	Transmit Data Hold after TCLK ³	0	0		ns
t_{SCLKW}	TCLK/RCLK Width	$(t_{SCLK}/2) - 2$	$(t_{SCLK}/2) + 2$	$(t_{SCLK}/2) - 2.5$ $(t_{SCLK}/2) + 2.5$	ns
Enable and Three-State					
<i>Switching Characteristics:</i>					
t_{DDTEN}	Data Enable from External TCLK ³	3.5	4.0		ns
t_{DDTTE}	Data Disable from External TCLK ³		10.5	10.5	ns
t_{DDTIN}	Data Enable from Internal TCLK ³	0	0		ns
t_{DDTTI}	Data Disable from Internal TCLK ³		3	3	ns
t_{DCLK}	TCLK/RCLK Delay from CLKIN		22 + 3D T/8	22 + 3D T/8	ns
t_{DPTR}	SPORT Disable after CLKIN		17	17	ns
Gated SCLK with External TFS (Mesh Multiprocessing)⁴					
<i>Timing Requirements:</i>					
t_{STFSCN}	TFS Setup before CLKIN	5	5		ns
t_{HTFSCN}	TFS Hold after CLKIN	$t_{CK}/2$	$t_{CK}/2$		ns
External Late Frame Sync					
<i>Switching Characteristics:</i>					
$t_{DDTLFSE}$	Data Delay from Late External TFS or External RFS with MCE = 1, MFD = 0 ⁵		12	12.8	ns
$t_{DDTENFS}$	Data Enable from late FS or MCE = 1, MFD = 0 ⁵	3	3.5		ns

To determine whether communication is possible between two devices at clock speed n , the following specifications must be confirmed: 1) frame sync delay & frame sync setup and hold, 2) data delay & data setup and hold, and 3) SCLK width.

ADSP-21060C/ADSP-21060LC

NOTES

- ¹Referenced to sample edge.
- ²RFS hold after RCLK when MCE = 1, MFD = 0 is 0 nsm in im um from drive edge. TFS hold after TCLK for late external TFS is 0 nsm in im um from drive edge.
- ³Referenced to drive edge.
- ⁴Applies only to gated serial clock mode used for serial port system I/O in mesh multiprocessing systems.
- ⁵MCE = 1, TFS enable and TFS valid follow $t_{D T L F S E}$ and $t_{D T E N F S}$.

DATA RECEIVE- INTERNAL CLOCK

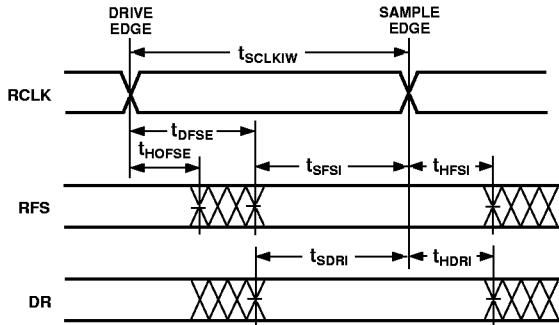

DATA RECEIVE- EXTERNAL CLOCK

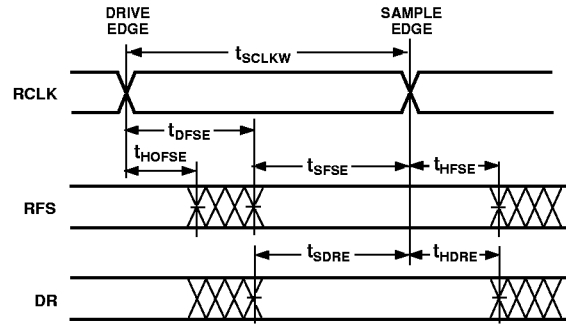

NOTE: EITHER THE RISING EDGE OR FALLING EDGE OF RCLK, TCLK CAN BE USED AS THE ACTIVE SAMPLING EDGE.

DATA TRANSMIT- INTERNAL CLOCK

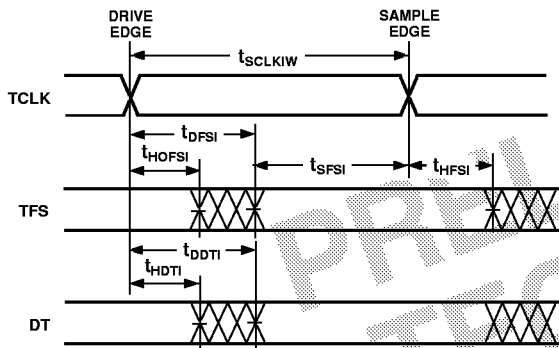

DATA TRANSMIT- EXTERNAL CLOCK

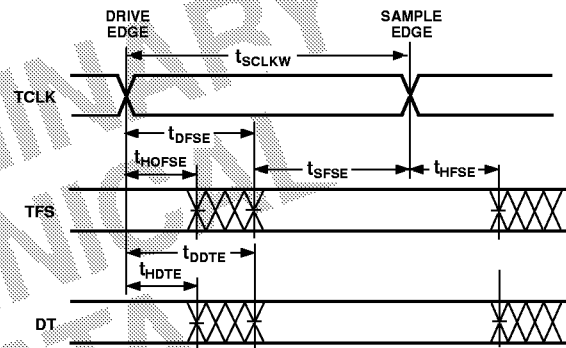

NOTE: EITHER THE RISING EDGE OR FALLING EDGE OF RCLK, TCLK CAN BE USED AS THE ACTIVE SAMPLING EDGE.

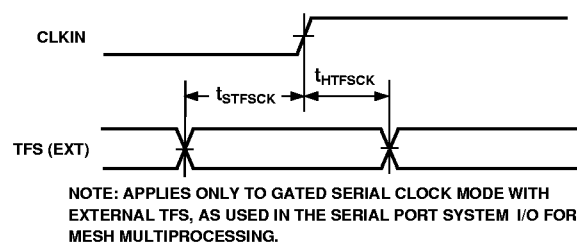
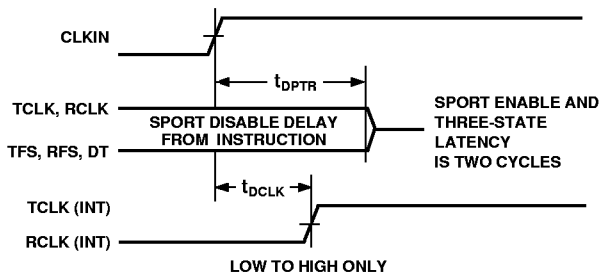
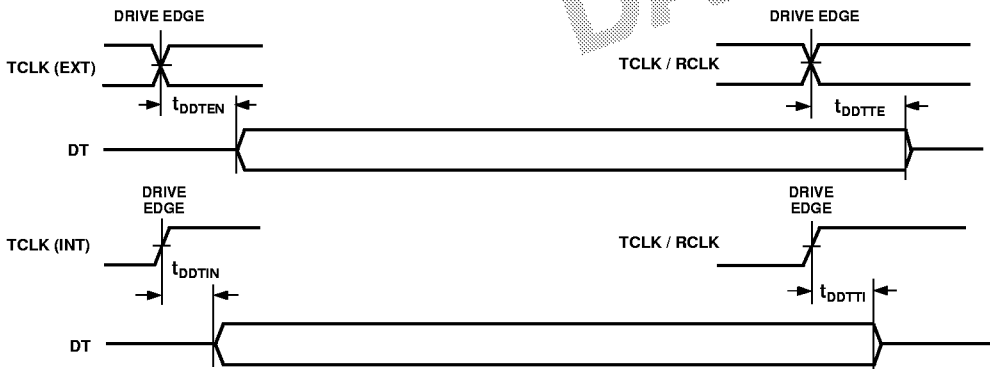

NOTE: APPLIES ONLY TO GATED SERIAL CLOCK MODE WITH EXTERNAL TFS, AS USED IN THE SERIAL PORT SYSTEM I/O FOR MESH MULTIPROCESSING.

Figure 22. Serial Ports

EXTERNAL RFS with MCE = 1, MFD = 0

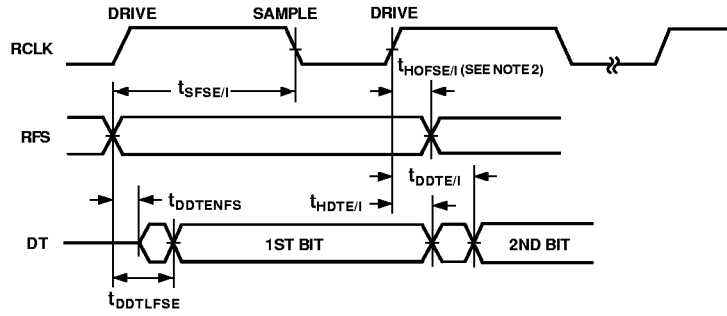

LATE EXTERNAL TFS

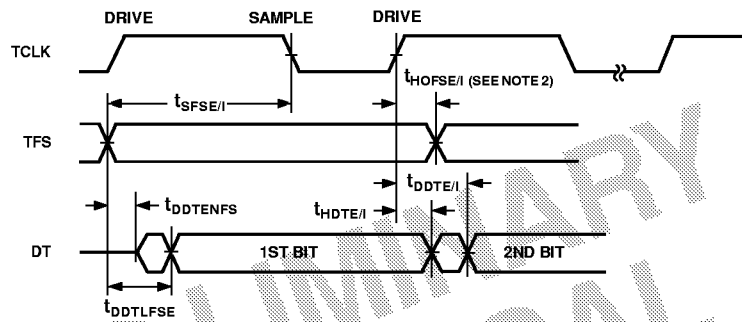

Figure 23. External Late Frame Sync

PRELIMINARY
TECHNICAL
DATA

ADSP-21060C/ADSP-21060LC

JTAG Test Access Port and Emulation

Parameter	ADSP-21060C		ADSP-21060LC		Units
	Min	Max	Min	Max	
Timing Requirements:					
t_{TCK}	TCK Period		t_{CCK}		ns
t_{STAP}	TDI, TMS Setup before TCK High		5		ns
t_{HTAP}	TDI, TMS Hold after TCK High		6		ns
t_{SSYS}	System Inputs Setup before TCK Low ¹		7		ns
t_{HSYS}	System Inputs Hold after TCK Low ¹		18		ns
t_{TRSTW}	\overline{TRST} Pulse Width		$4t_{CCK}$		ns
Switching Characteristics:					
$t_{D TDO}$	TDO Delay from TCK Low			13	ns
$t_{D SYS}$	System Outputs Delay after TCK Low ²			18.5	ns

NOTES

¹System Inputs = DATA₄₇₋₀, ADDR₃₁₋₀, \overline{RD} , \overline{WR} , \overline{ACK} , \overline{SBTS} , \overline{SW} , \overline{HBR} , \overline{HBG} , \overline{CS} , $\overline{DMAR1}$, $\overline{DMAR2}$, \overline{BR}_{6-1} , \overline{ID}_{2-0} , \overline{RPBA} , \overline{IRQ}_{2-0} , \overline{FLAG}_{3-0} , $\overline{DR0}$, $\overline{DR1}$, $\overline{TCLK0}$, $\overline{TCLK1}$, $\overline{RCLK0}$, $\overline{RCLK1}$, $\overline{TFS0}$, $\overline{TFS1}$, $\overline{RFS0}$, $\overline{RFS1}$, \overline{LxDAT}_{3-0} , \overline{LxCLK} , \overline{LxACK} , \overline{EBOOT} , \overline{LBOOT} , \overline{BMS} , \overline{CLKIN} , \overline{RESET} .

²System Outputs = DATA₄₇₋₀, ADDR₃₁₋₀, \overline{MS}_{3-0} , \overline{RD} , \overline{WR} , \overline{ACK} , \overline{PAGE} , \overline{ADRCLK} , \overline{SW} , \overline{HBG} , \overline{REDY} , $\overline{DMAG1}$, $\overline{DMAG2}$, \overline{BR}_{6-1} , \overline{CPA} , \overline{FLAG}_{3-0} , \overline{TIMEXP} , $\overline{DT0}$, $\overline{DT1}$, $\overline{TCLK0}$, $\overline{TCLK1}$, $\overline{RCLK0}$, $\overline{RCLK1}$, $\overline{TFS0}$, $\overline{TFS1}$, $\overline{RFS0}$, $\overline{RFS1}$, \overline{LxDAT}_{3-0} , \overline{LxCLK} , \overline{LxACK} , \overline{BMS} .

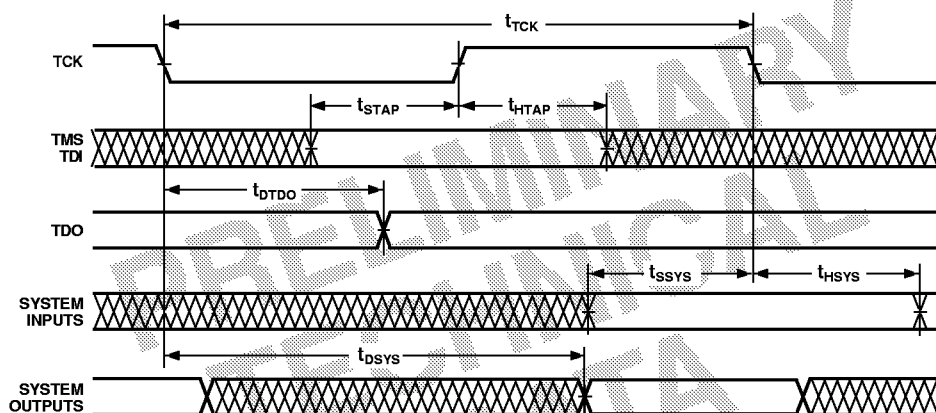

Figure 24. IEEE 11499.1 JTAG Test Access Port

OUTPUT DRIVE CURRENTS

Figure 28 shows typical I-V characteristics for the output drivers of the AD SP-2106x. The curves represent the current drive capability of the output drivers as a function of output voltage.

POWER DISSIPATION

Total power dissipation has two components, one due to internal circuitry and one due to the switching of external output drivers. Internal power dissipation is dependent on the instruction execution sequence and the data operands involved. Internal power dissipation is calculated in the following way:

$$P_{INT} = I_{DDIN} \times V_{DD}$$

The external component of total power dissipation is caused by the switching of output pins. Its magnitude depends on:

- the number of output pins that switch during each cycle (O)
- the maximum frequency at which they can switch (f)
- their load capacitance (C)
- their voltage swing (V_{DD})

and is calculated by:

$$P_{EXT} = O \times C \times V_{DD}^2 \times f$$

The load capacitance should include the processor's package capacitance (C_{IN}). The switching frequency includes driving the load high and then back low. Address and data pins can drive high and low at a maximum rate of $1/(2t_{CK})$. The write strobe can switch every cycle at a frequency of $1/t_{CK}$. Select pins switch at $1/(2t_{CK})$, but selects can switch on each cycle.

Example

Estimate P_{EXT} with the following assumptions:

- A system with one bank of external data memory RAM (32-bit)
- Four 128K \times 8 RAM chips are used, each with a load of 10 pF
- External data memory writes occur every other cycle, a rate of $1/(4t_{CK})$, with 50% of the pins switching
- The instruction cycle rate is 40 MHz ($t_{CK} = 25$ ns).

The P_{EXT} equation is calculated for each class of pins that can drive:

Table II. External Power Calculations (5 V Device)

Pin Type	# of Pins	% Switching	$\times C$	$\times f$	$\times V_{DD}^2 = P_{EXT}$
Address	15	50	$\times 44.7$ pF	$\times 10$ MHz	$\times 25$ V = 0.084 W
<u>MS0</u>	1	0	$\times 44.7$ pF	$\times 10$ MHz	$\times 25$ V = 0.000 W
<u>WR</u>	1	-	$\times 44.7$ pF	$\times 20$ MHz	$\times 25$ V = 0.022 W
Data	32	50	$\times 14.7$ pF	$\times 10$ MHz	$\times 25$ V = 0.059 W
ADDRESS LK	1	-	$\times 4.7$ pF	$\times 20$ MHz	$\times 25$ V = 0.002 W

$$P_{EXT} = 0.167 \text{ W}$$

Table III. External Power Calculations (3.3 V Device)

Pin Type	# of Pins	% Switching	$\times C$	$\times f$	$\times V_{DD}^2 = P_{EXT}$
Address	15	50	$\times 44.7$ pF	$\times 10$ MHz	$\times 10.9$ V = 0.037 W
<u>MS0</u>	1	0	$\times 44.7$ pF	$\times 10$ MHz	$\times 10.9$ V = 0.000 W
<u>WR</u>	1	-	$\times 44.7$ pF	$\times 20$ MHz	$\times 10.9$ V = 0.010 W
Data	32	50	$\times 14.7$ pF	$\times 10$ MHz	$\times 10.9$ V = 0.026 W
ADDRESS LK	1	-	$\times 4.7$ pF	$\times 20$ MHz	$\times 10.9$ V = 0.001 W

$$P_{EXT} = 0.074 \text{ W}$$

A typical power consumption can now be calculated for these conditions by adding a typical internal power dissipation:

$$P_{TOTAL} = P_{EXT} + (I_{DDIN2} \times 5.0 \text{ V})$$

Note that the conditions causing a worst-case P_{EXT} are different from those causing a worst-case P_{INT} . Maximum P_{INT} cannot occur while 100% of the output pins are switching from all ones to all zeros. Note also that it is not common for an application to have 100% or even 50% of the outputs switching simultaneously.

TEST CONDITIONS

Output Disable Time

Output pins are considered to be disabled when they stop driving, go into a high impedance state, and start to decay from their output high or low voltage. The time for the voltage on the bus to decay by ΔV is dependent on the capacitive load, C_L and the load current, I_L . This decay time can be approximated by the following equation:

$$t_{DECAY} = \frac{C_L \Delta V}{I_L}$$

The output disable time t_{DIS} is the difference between $t_{MEASURED}$ and t_{DECAY} as shown in Figure 25. The time $t_{MEASURED}$ is the interval from when the reference signal switches to when the output voltage decays ΔV from the measured output high or output low voltage. t_{DECAY} is calculated with test loads C_L and I_L , and with ΔV equal to 0.5 V.

Output Enable Time

Output pins are considered to be enabled when they have made a transition from a high impedance state to when they start driving. The output enable time t_{ENA} is the interval from when a reference signal reaches a high or low voltage level to when the output has reached a specified high or low trip point, as shown in the Output Enable/Disable diagram (Figure 25). If multiple pins (such as the data bus) are enabled, the measurement value is that of the first pin to start driving.

ADSP-21060C/ADSP-21060LC

Example System Hold Time Calculation

To determine the data output hold time in a particular system, first calculate t_{DECAY} using the equation given above. Choose ΔV to be the difference between the ADSP-2106x's output voltage and the input threshold for the device requiring the hold time. A typical ΔV will be 0.4 V. C_L is the total bus capacitance (per data line), and I_L is the total leakage or three-state current (per data line). The hold time will be t_{DECAY} plus the minimum disable time (i.e., t_{DATRWH} for the write cycle).

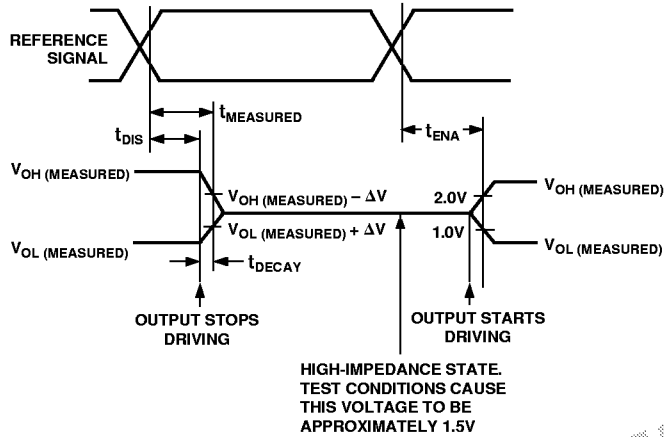

Figure 25. Output Enable/Disable

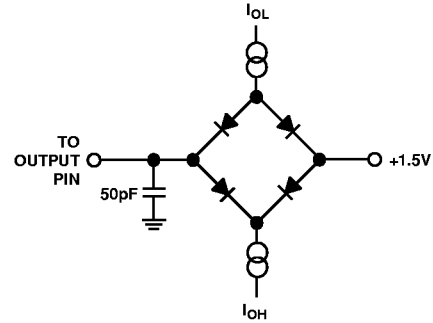

Figure 26. Equivalent Device Loading for AC Measurements (Includes All Fixtures)



Figure 27. Voltage Reference Levels for AC Measurements (Except Output Enable/Disable)

Capacitive Loading

Output delays and holds are based on standard capacitive loads: 50 pF on all pins (see Figure 26). The delay and hold specifications given should be derated by a factor of 1.5 ns/50 pF for loads other than the nominal value of 50 pF. Figures 29–30, 33–34 show how output rise time varies with capacitance. Figures 31, 35 show graphically how output delays and holds vary with load capacitance. (Note that this graph or derating does not apply to output disable delays; see the previous section **Output Disable Time** under Test Conditions.) The graphs of Figures 29, 30 and 31 may not be linear outside the ranges shown.

PRELIMINARY
TECHNICAL
DATA

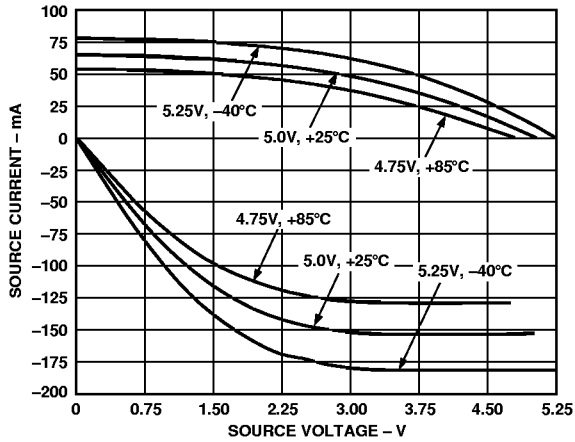

Figure 28. ADSP-2106x Typical Drive Currents ($V_{DD} = 5\text{ V}$)

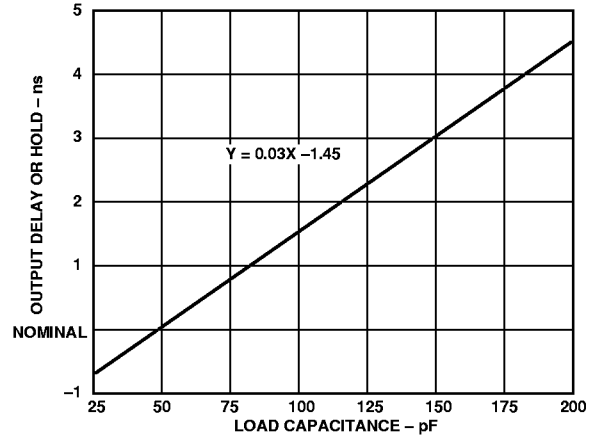

Figure 31. Typical Output Delay or Hold vs. Load Capacitance (at Maximum Case Temperature) ($V_{DD} = 5\text{ V}$)

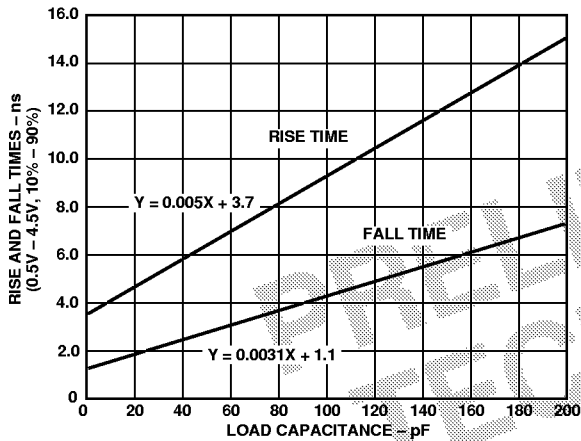

Figure 29. Typical Output Rise Time (10%–90% V_{DD}) vs. Load Capacitance ($V_{DD} = 5\text{ V}$)

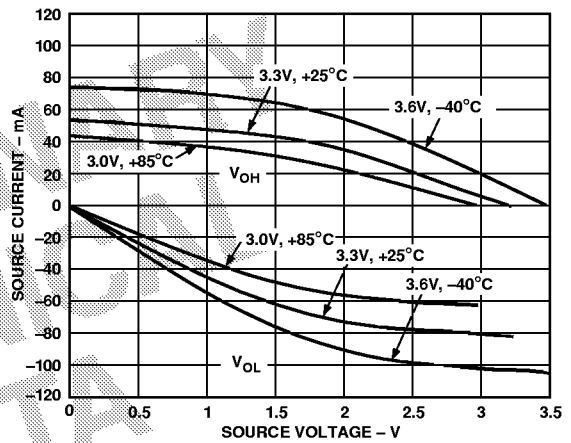

Figure 32. ADSP-2106x Typical Drive Currents ($V_{DD} = 3.3\text{ V}$)

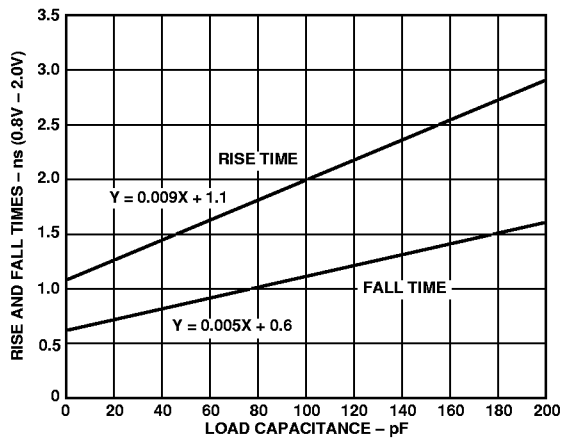

Figure 30. Typical Output Rise Time (0.8 V–2.0 V) vs. Load Capacitance ($V_{DD} = 5\text{ V}$)

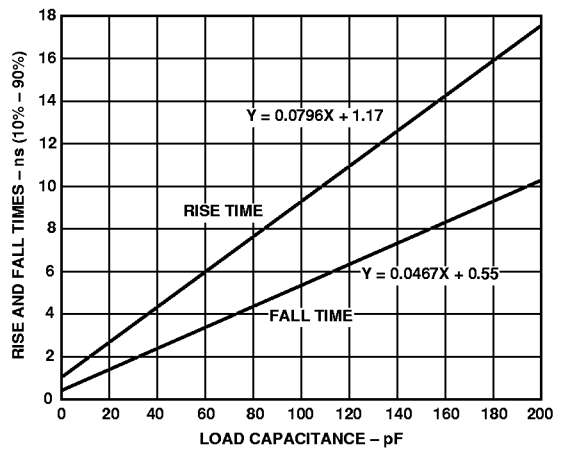

Figure 33. Typical Output Rise Time (10%–90% V_{DD}) vs. Load Capacitance ($V_{DD} = 3.3\text{ V}$)

ADSP-21060C/ADSP-21060LC

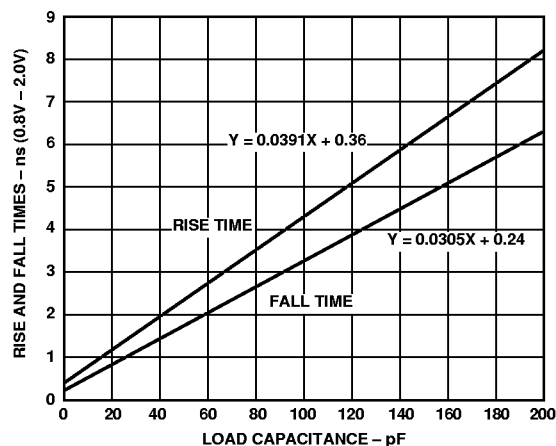

Figure 34. Typical Output Rise Time (0.8 V–2.0 V) vs. Load Capacitance ($V_{DD} = 3.3$ V)

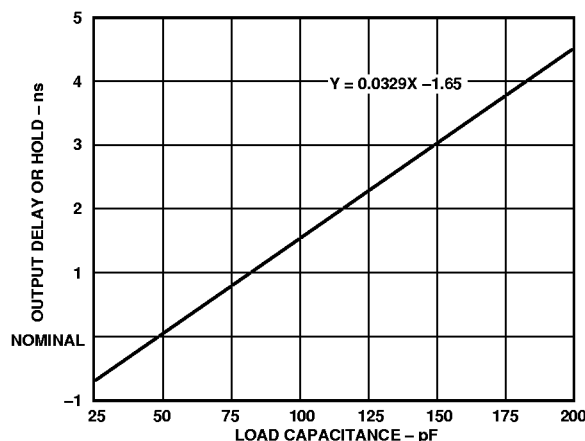

Figure 35. Typical Output Delay or Hold vs. Load Capacitance (at Maximum Case Temperature) ($V_{DD} = 3.3$ V)

ENVIRONMENTAL CONDITIONS

Thermal Characteristics

The AD SP-2106x is packaged in a 240-lead thermally enhanced ceramic QFP (CQFP). There are two package versions, one with a copper/tungsten heat slug on top of the package (CZ) for air cooling, and one with the heat slug on the bottom (CW) for cooling through the board. The AD SP-2106x is specified for a case temperature (T_{CASE}). To ensure that the T_{CASE} data sheet specification is not exceeded, a heatsink and/or an air flow source may be used. A heatsink should be attached with a thermal adhesive.

$$T_{CASE} = T_{AMB} + (PD \times \theta_{CA})$$

T_{CASE} = Case temperature (measured on the heat slug surface)

PD = Power dissipation in W (this value depends upon the specific application; a method for calculating PD is shown under Power Dissipation).

θ_{CA} = Value from the following table.

Airflow (Linear Ft./Min.)	0	200	400
θ_{CA} ($^{\circ}C/W$)	18	13	11

NOTES

This represents thermal resistance at total power of 5 W.

With air flow, no variance is seen in θ_{CA} with power.

$\theta_{JC} = 0.2^{\circ}C/W$.

240-LEAD METRIC CQFP PIN CONFIGURATIONS HEAT SLUG UP VERSION (CZ)

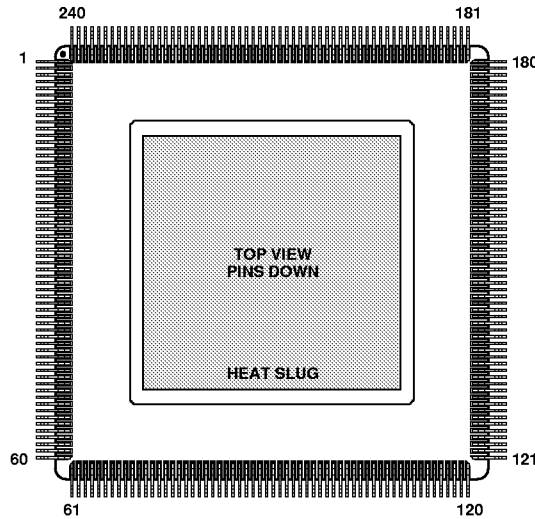

THE 240-LEAD PACKAGE CONTAINS A COPPER/TUNGSTON
HEAT SLUG ON ITS TOP SURFACE.

Pin No.	Pin Name	Pin No.	Pin Name	Pin No.	Pin Name	Pin No.	Pin Name	Pin No.	Pin Name
1	<u>TDI</u>	41	ADDR20	81	TCLK0	121	DATA41	161	DATA14
2	<u>TRST</u>	42	ADDR21	82	TFS0	122	DATA40	162	DATA13
3	VDD	43	GND	83	DR0	123	DATA39	163	DATA12
4	TDO	44	ADDR22	84	RCLK0	124	VDD	164	GND
5	<u>TMEXP</u>	45	ADDR23	85	RFS0	125	DATA38	165	DATA11
6	<u>EMU</u>	46	ADDR24	86	VDD	126	DATA37	166	DATA10
7	ICSA	47	VDD	87	VDD	127	DATA36	167	DATA9
8	FLAG3	48	GND	88	GND	128	GND	168	VDD
9	FLAG2	49	VDD	89	ADCLK	129	NC	169	DATA8
10	FLAG1	50	ADDR25	90	<u>REDY</u>	130	DATA35	170	DATA7
11	FLAG0	51	ADDR26	91	<u>HBG</u>	131	DATA34	171	DATA6
12	GND	52	ADDR27	92	<u>CS</u>	132	DATA33	172	GND
13	ADDR0	53	GND	93	<u>RD</u>	133	VDD	173	DATA5
14	ADDR1	54	<u>MS3</u>	94	<u>WR</u>	134	VDD	174	DATA4
15	VDD	55	<u>MS2</u>	95	GND	135	GND	175	DATA3
16	ADDR2	56	<u>MS1</u>	96	VDD	136	DATA32	176	VDD
17	ADDR3	57	<u>MS0</u>	97	GND	137	DATA31	177	DATA2
18	ADDR4	58	<u>SW</u>	98	CLKIN	138	DATA30	178	DATA1
19	GND	59	<u>BMS</u>	99	ACK	139	GND	179	DATA0
20	ADDR5	60	ADDR28	100	<u>DMAG2</u>	140	DATA29	180	GND
21	ADDR6	61	GND	101	<u>DMAG1</u>	141	DATA28	181	GND
22	ADDR7	62	VDD	102	PAGE	142	DATA27	182	L0DAT3
23	VDD	63	VDD	103	VDD	143	VDD	183	L0DAT2
24	ADDR8	64	ADDR29	104	<u>BR6</u>	144	VDD	184	L0DAT1
25	ADDR9	65	ADDR30	105	<u>BR5</u>	145	DATA26	185	L0DAT0
26	ADDR10	66	ADDR31	106	<u>BR4</u>	146	DATA25	186	L0CLK
27	GND	67	GND	107	<u>BR3</u>	147	DATA24	187	L0ACK
28	ADDR11	68	<u>SBTS</u>	108	<u>BR2</u>	148	GND	188	VDD
29	ADDR12	69	<u>DMAR2</u>	109	<u>BR1</u>	149	DATA23	189	L1DAT3
30	ADDR13	70	<u>DMARI</u>	110	GND	150	DATA22	190	L1DAT2
31	VDD	71	<u>HBR</u>	111	VDD	151	DATA21	191	L1DAT1
32	ADDR14	72	DT1	112	GND	152	VDD	192	L1DAT0
33	ADDR15	73	TCLK1	113	DATA47	153	DATA20	193	L1CLK
34	GND	74	TFS1	114	DATA46	154	DATA19	194	L1ACK
35	ADDR16	75	DR1	115	DATA45	155	DATA18	195	GND
36	ADDR17	76	RCLK1	116	VDD	156	GND	196	GND
37	ADDR18	77	RFS1	117	DATA44	157	DATA17	197	VDD
38	VDD	78	GND	118	DATA43	158	DATA16	198	L2DAT3
39	VDD	79	<u>CPA</u>	119	DATA42	159	DATA15	199	L2DAT2
40	ADDR19	80	DT0	120	GND	160	VDD	200	L2DAT1
								201	L2DAT0
								202	L2CLK
								203	L2ACK
								204	NC
								205	VDD
								206	L3DAT3
								207	L3DAT2
								208	L3DAT1
								209	L3DAT0
								210	L3CLK
								211	L3ACK
								212	GND
								213	L4DAT3
								214	L4DAT2
								215	L4DAT1
								216	L4DAT0
								217	L4CLK
								218	L4ACK
								219	VDD
								220	GND
								221	VDD
								222	L5DAT3
								223	L5DAT2
								224	L5DAT1
								225	L5DAT0
								226	L5CLK
								227	L5ACK
								228	GND
								229	ID2
								230	ID1
								231	ID0
								232	LBOOT
								233	<u>RPBA</u>
								234	<u>RESET</u>
								235	<u>EBOOT</u>
								236	<u>IRQ2</u>
								237	<u>IRQ1</u>
								238	<u>IRQ0</u>
								239	TCK
								240	TMS

ADSP-21060C/ADSP-21060LC

240-LEAD METRIC CQFP PIN CONFIGURATIONS HEAT SLUG DOWN VERSION (CW)

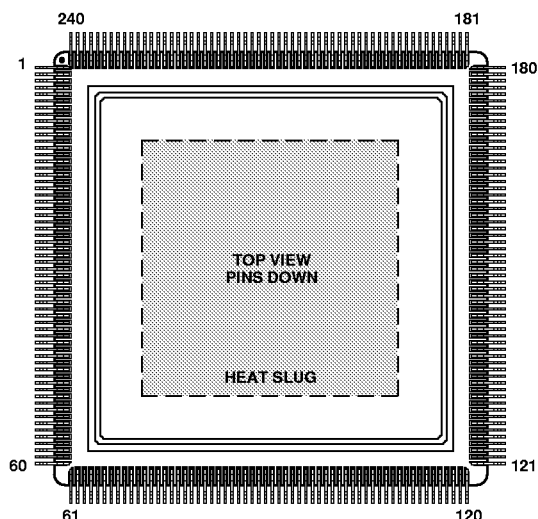

THE 240-LEAD PACKAGE CONTAINS A COPPER/TUNGSTON HEAT SLUG ON ITS BOTTOM SURFACE.

Pin No.	Pin Name	Pin No.	Pin Name	Pin No.	Pin Name	Pin No.	Pin Name	Pin No.	Pin Name
1	GND	41	DATA29	81	<u>DMAG2</u>	121	ADDR28	161	ADDR5
2	DATA0	42	GND	82	ACK	122	BMS	162	GND
3	DATA1	43	DATA30	83	CLK IN	123	SW	163	ADDR4
4	DATA2	44	DATA31	84	GND	124	MS0	164	ADDR3
5	VDD	45	DATA32	85	VDD	125	MS1	165	ADDR2
6	DATA3	46	GND	86	GND	126	MS2	166	VDD
7	DATA4	47	VDD	87	<u>WR</u>	127	MS3	167	ADDR1
8	DATA5	48	VDD	88	<u>RD</u>	128	GND	168	ADDR0
9	GND	49	DATA33	89	<u>CS</u>	129	ADDR27	169	GND
10	DATA6	50	DATA34	90	<u>HBG</u>	130	ADDR26	170	FLAG0
11	DATA7	51	DATA35	91	REDY	131	ADDR25	171	FLAG1
12	DATA8	52	NC	92	ADRCLK	132	VDD	172	FLAG2
13	VDD	53	GND	93	GND	133	GND	173	FLAG3
14	DATA9	54	DATA36	94	VDD	134	VDD	174	<u>ICSA</u>
15	DATA10	55	DATA37	95	VDD	135	ADDR24	175	<u>EMU</u>
16	DATA11	56	DATA38	96	RFS0	136	ADDR23	176	TIMEXP
17	GND	57	VDD	97	RCLK0	137	ADDR22	177	TDO
18	DATA12	58	DATA39	98	DR0	138	GND	178	VDD
19	DATA13	59	DATA40	99	TFS0	139	ADDR21	179	<u>TRST</u>
20	DATA14	60	DATA41	100	TCLK0	140	ADDR20	180	TDI
21	VDD	61	GND	101	<u>DT0</u>	141	ADDR19	181	TMS
22	DATA15	62	DATA42	102	<u>CPA</u>	142	VDD	182	TCK
23	DATA16	63	DATA43	103	GND	143	VDD	183	<u>IRQ0</u>
24	DATA17	64	DATA44	104	RFS1	144	ADDR18	184	<u>IRQ1</u>
25	GND	65	VDD	105	RCLK1	145	ADDR17	185	<u>IRQ2</u>
26	DATA18	66	DATA45	106	DR1	146	ADDR16	186	<u>EBOOT</u>
27	DATA19	67	DATA46	107	TFS1	147	GND	187	<u>RESET</u>
28	DATA20	68	DATA47	108	TCLK1	148	ADDR15	188	RPBA
29	VDD	69	GND	109	DT1	149	ADDR14	189	LBOOT
30	DATA21	70	VDD	110	<u>HBR</u>	150	VDD	190	ID0
31	DATA22	71	GND	111	<u>DMARI</u>	151	ADDR13	191	ID1
32	DATA23	72	<u>BR1</u>	112	<u>DMAR2</u>	152	ADDR12	192	ID2
33	GND	73	<u>BR2</u>	113	<u>SBTS</u>	153	ADDR11	193	GND
34	DATA24	74	<u>BR3</u>	114	GND	154	GND	194	L5ACK
35	DATA25	75	<u>BR4</u>	115	ADDR31	155	ADDR10	195	L5CLK
36	DATA26	76	<u>BR5</u>	116	ADDR30	156	ADDR9	196	L5DAT0
37	VDD	77	<u>BR6</u>	117	ADDR29	157	ADDR8	197	L5DAT1
38	VDD	78	VDD	118	VDD	158	VDD	198	L5DAT2
39	DATA27	79	<u>PAGE</u>	119	VDD	159	ADDR7	199	L5DAT3
40	DATA28	80	<u>DMAG1</u>	120	GND	160	ADDR6	200	VDD
								201	GND
								202	VDD
								203	L4ACK
								204	L4CLK
								205	L4DAT0
								206	L4DAT1
								207	L4DAT2
								208	L4DAT3
								209	GND
								210	L3ACK
								211	L3CLK
								212	L3DAT0
								213	L3DAT1
								214	L3DAT2
								215	L3DAT3
								216	VDD
								217	NC
								218	L2ACK
								219	L2CLK
								220	L2DAT0
								221	L2DAT1
								222	L2DAT2
								223	L2DAT3
								224	VDD
								225	GND
								226	GND
								227	L1ACK
								228	L1CLK
								229	L1DAT0
								230	L1DAT1
								231	L1DAT2
								232	L1DAT3
								233	VDD
								234	L0ACK
								235	L0CLK
								236	L0DAT0
								237	L0DAT1
								238	L0DAT2
								239	L0DAT3
								240	GND

ADSP-21060C/ADSP-21060LC

OUTLINE DIMENSIONS

Dimensions shown in inches and (millimeters).

240-Lead CQFP with Heat Slug Up and Formed Leads (QS-240)

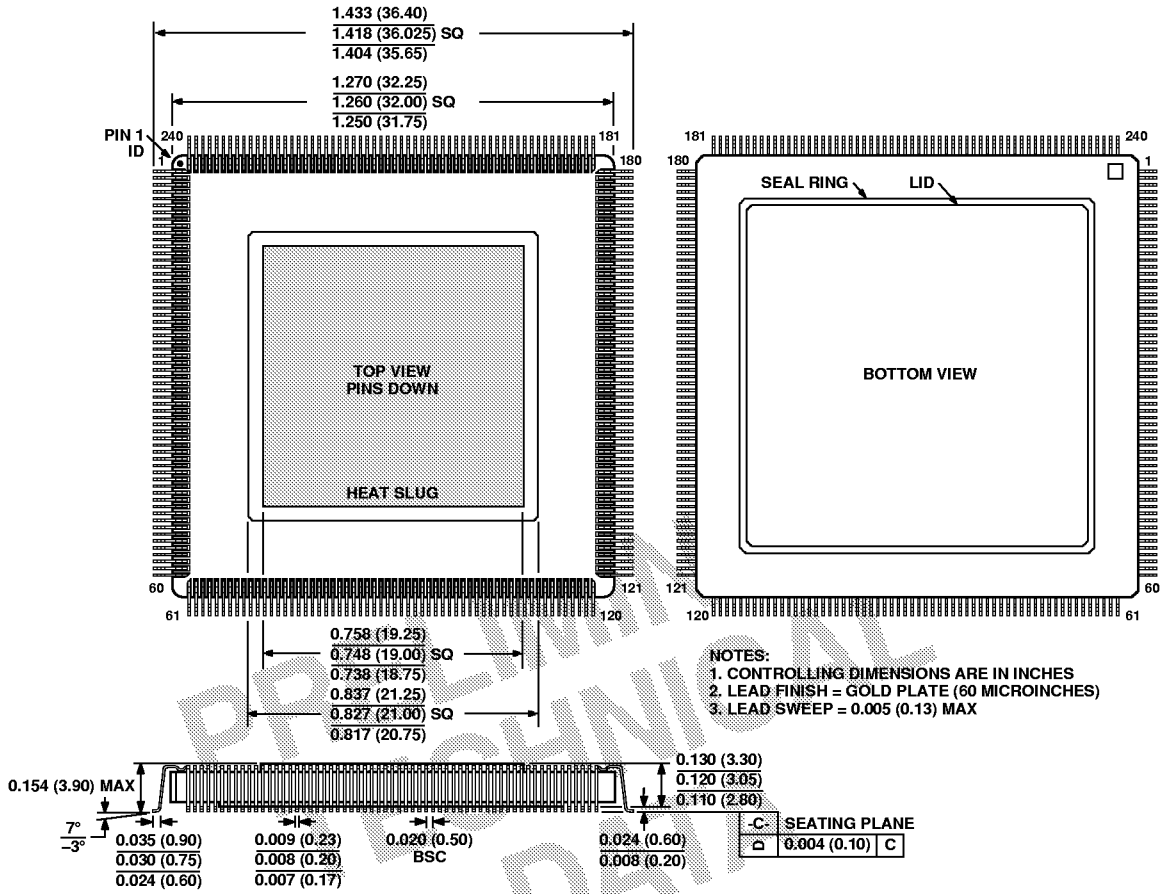

ADSP-21060C/ADSP-21060LC

OUTLINE DIMENSIONS

Dimensions shown in inches and (in millimeters).

240-Lead Metric CQFP with Heat Slug Up and Unformed Leads (QS-240)

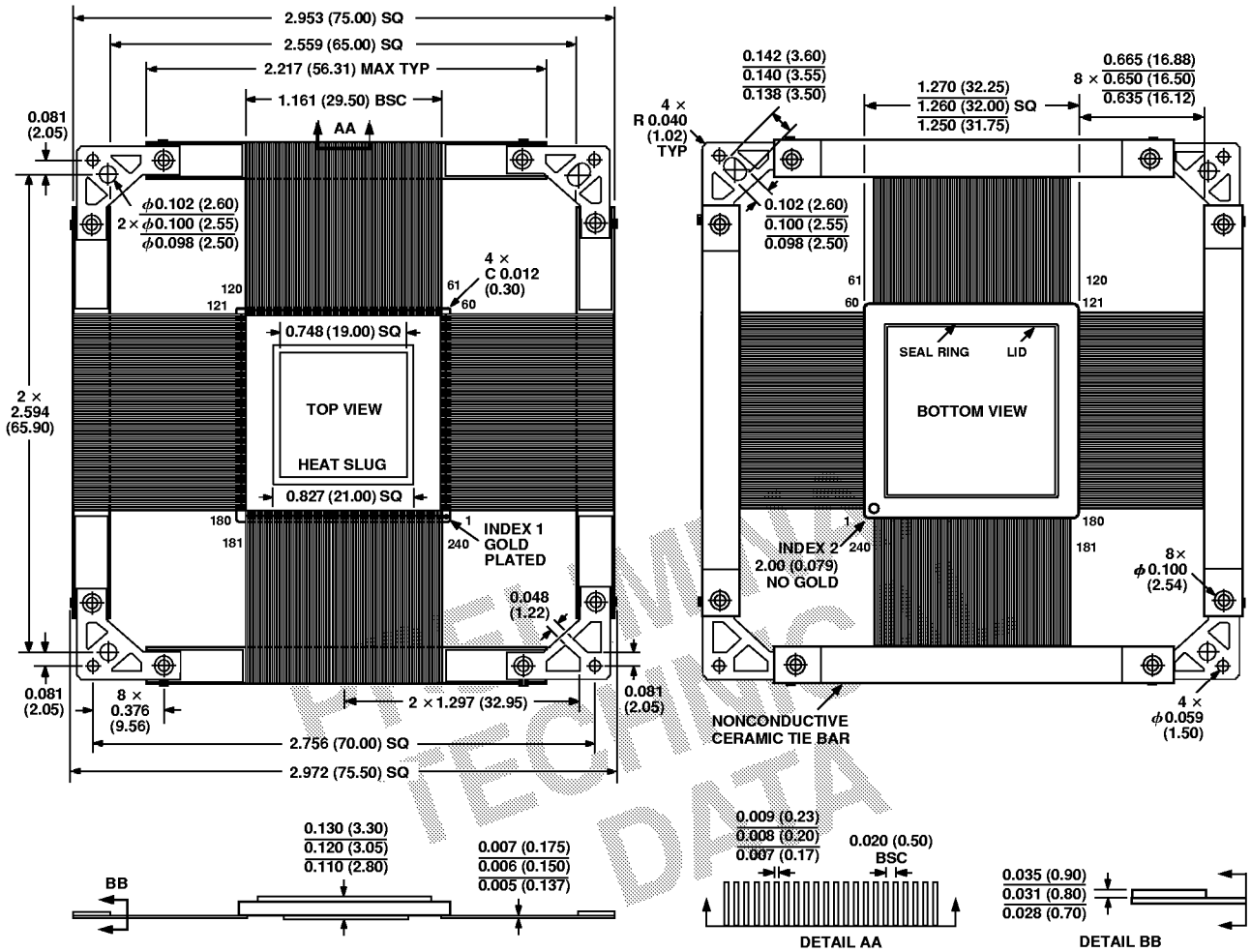

OUTLINE DIMENSIONS

Dimensions shown in inches and (in millimeters).

240-Lead Metric CQFP with Heat Slug Down and Formed Leads (QS-240A)

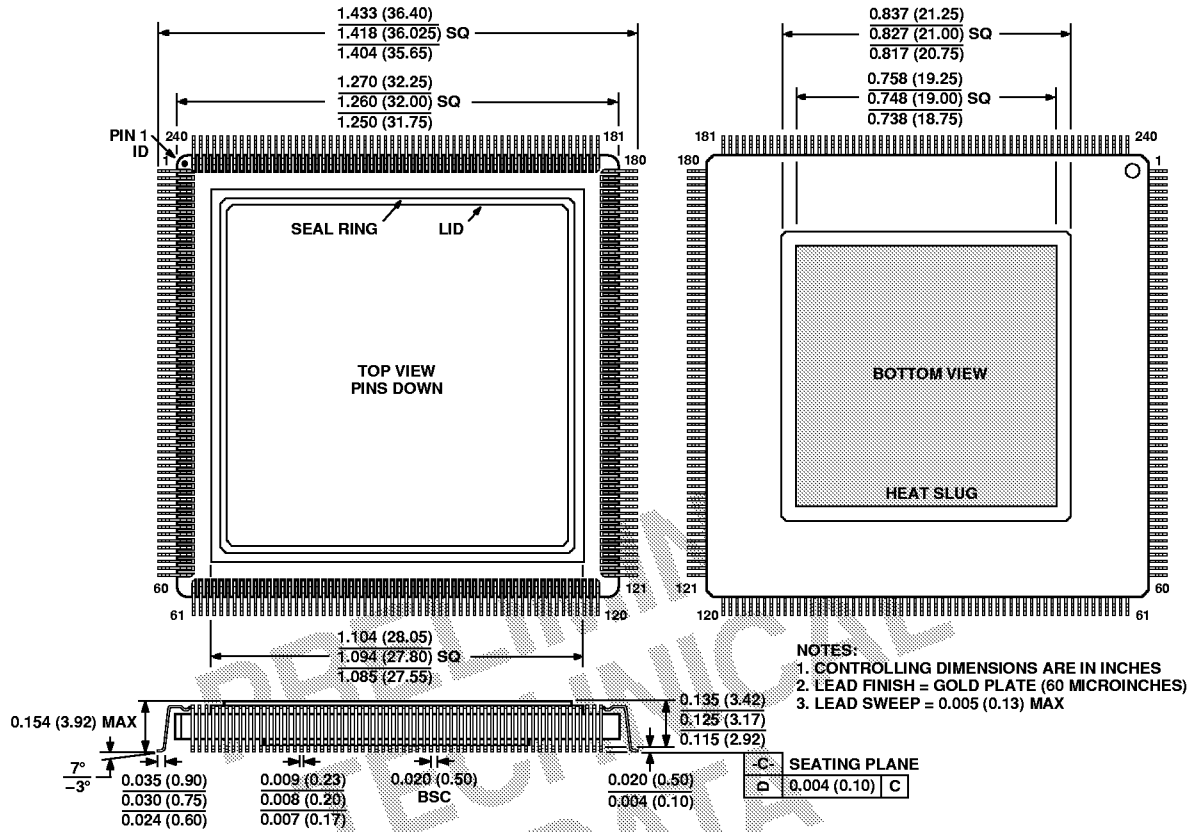

ADSP-21060C/ADSP-21060LC

OUTLINE DIMENSIONS

Dimensions shown in inches and (in millimeters).

240-Lead Metric CQFP with Heat Slug Down and Unformed Leads (QS-240A)

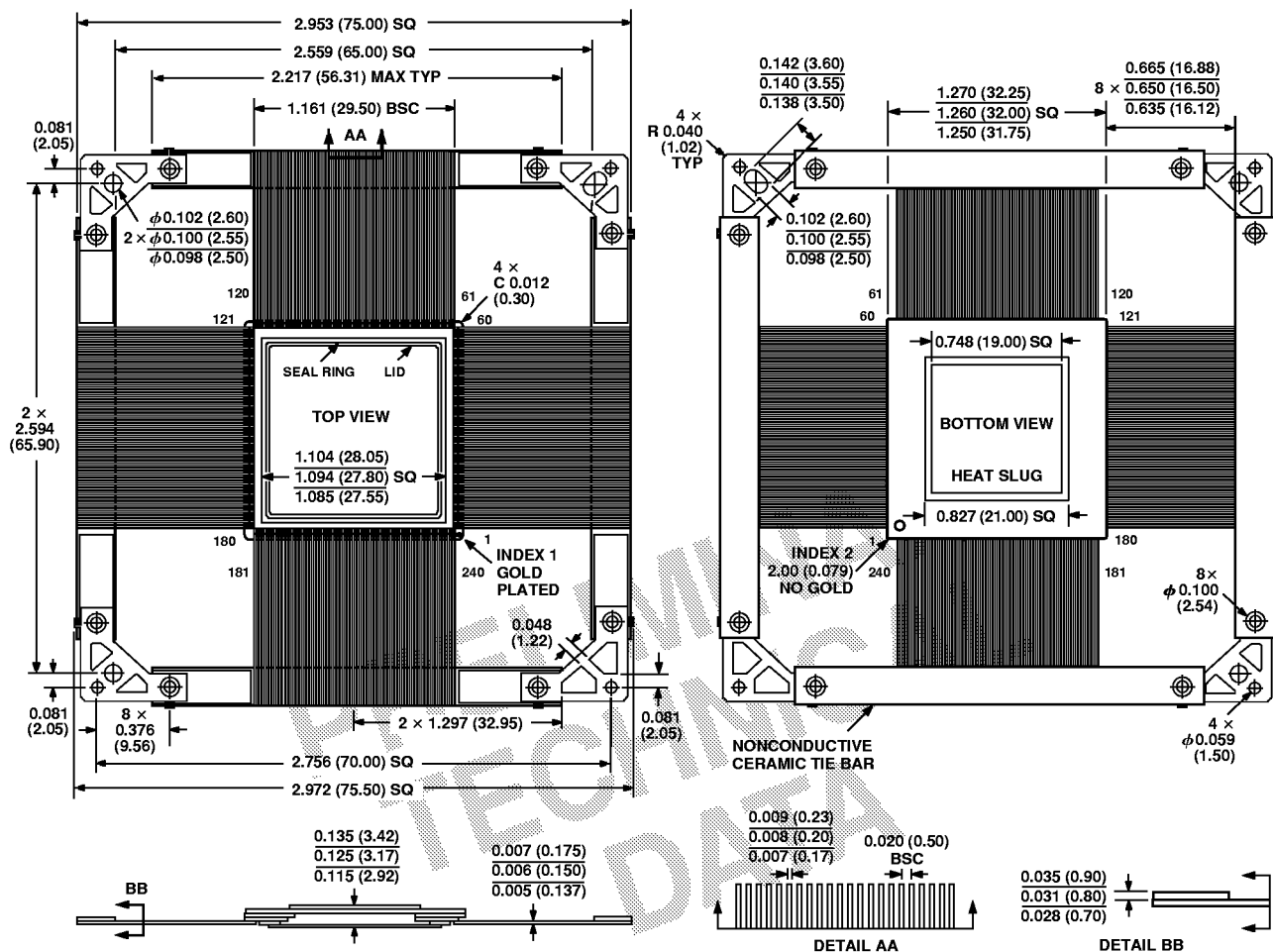

C03352-8-7/98

ORDERING GUIDE

Part Number	Case Temperature Range	Heat Slug Orientation	Instruction Rate	Operating Voltage
ADSP-21060CZ-133	-40°C to +100°C	Heat Slug Up	33 MHz	5 V
ADSP-21060CZ-160	-40°C to +100°C	Heat Slug Up	40 MHz	5 V
ADSP-21060CW-133	-40°C to +100°C	Heat Slug Down	33 MHz	5 V
ADSP-21060CW-160	-40°C to +100°C	Heat Slug Down	40 MHz	5 V
ADSP-21060LCW-133	-40°C to +100°C	Heat Slug Down	33 MHz	3.3 V
ADSP-21060LCW-160	-40°C to +100°C	Heat Slug Down	40 MHz	3.3 V

PRINTED IN U.S.A.