

MV-3 Series

Miniature Basic Switch

◆ Features

- ✓ Standard miniature, and durable, switch for mass application
- ✓ High temperature enclosure material is rated for V-0 fire resist
- ✓ Forms C, A, and B contact variations available

◆ Recognition(s)

- ✓ CE – EN61058-1
- ✓ UL – UL-508
- ✓ CCC – GB14048.5-2008
- ✓ CSA – 6241 90
- ✓ RoHS Compliant
- ✓ Reach Unaffected



◆ Characteristics

Positive Opening	Electrical Contact	Terminal Type	Contact Form(s)	Poles & Throws	Actuation Sequence(s)
------------------	--------------------	---------------	-----------------	----------------	-----------------------

No	2 or 3 Points	Quick connect (#187)	Form(s) C, A or B	SPDT, or SPST-NO, or SPST-NC	Break(1) Make(2) or single make or single break
----	---------------	----------------------	-------------------	------------------------------	---

Operating Temp.	AC Rated	DC Rated	IP	Oil Resist	Dust Resist	Water Resist	Operating Speed
-----------------	----------	----------	----	------------	-------------	--------------	-----------------

-25 to 80 Celsius, -25 to 120 Celsius	5A 125V-250V, 15A 125V-250V	0.5A 125V	40	No	No	No	0.01mm to 1m/sec
---------------------------------------	-----------------------------	-----------	----	----	----	----	------------------

Operation Frequency	Contact Resistance	Insulation Resistance	Vibration
---------------------	--------------------	-----------------------	-----------

Mechanically: 600/min Electrically: 60/min	15mΩ max. (initial)	100MΩ min. (500VDC)	1.5mm amplitude at 10-55Hz
---	---------------------	---------------------	----------------------------

Storage Humidity	Service Life (min.)	Dielectric Strength
------------------	---------------------	---------------------

85% RH max	Mechanically: 5,000,000 operations Electrically: 500,000 operations	1000VAC, 50/60Hz for 1 minute between non-continuous terminals
------------	--	--

Recommended tightening forces	Circuitry
-------------------------------	-----------

Purpose	Screw type	Tightening
Mounting	M3	0.39~0.59N·m

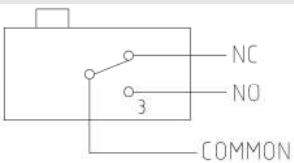

◆ Materials

Actuation touch part	Electrical contact point	Enclosure
Stainless Steel, or Phenolic, or POM thermoplastic, or Nickel-plated brass	Silver-Nickel Alloy	PC plastic with ABS

◆ Nomenclature

Series:	Actuator (and material):	Operating Force:	Amp code:	Contact Form:
MV –	3003	A		– NO

- 3000 = Phenolic Plunger
- 3001 = Metallic Lever, simulated roller
- 3002 = Metallic Lever, straight
- 3003 = Metallic Lever, straight long
- 3003L = Metallic Lever, straight long 55.5mm
- 3004 = Lever, nickel-plated brass roller
- 3005 = Lever, nickel-plated brass roller, long

A=Standard

Blank=5 Amps
20=**15 Amps**

Blank=Form C
NO=Form A
NC=Form B

V-0 fire resist (120C temp.)

- 3100 = Phenolic Plunger
- 3101 = Metallic Lever, simulated roller
- 3102 = Metallic Lever, straight
- 3103 = Metallic Lever, straight long
- 3104 = Lever, nickel-plated brass roller
- 3105 = Lever, nickel-plated brass roller, long

CUSTOM

- MV-3004A-P = Lever, POM roller
- MV-3005A-P = Lever, POM roller, long

◆ Dimensions & Operating Characteristics

*Measurements in millimeters

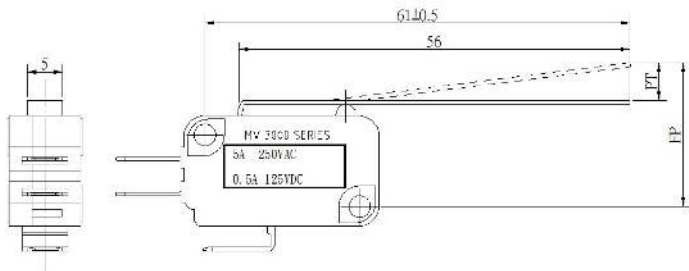
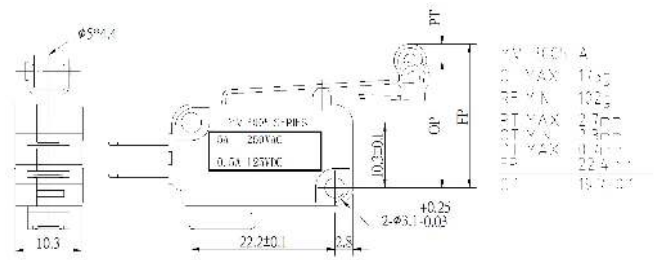
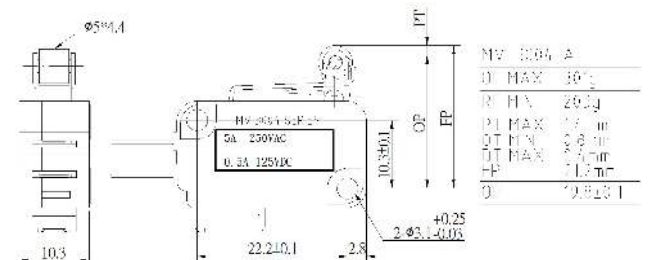
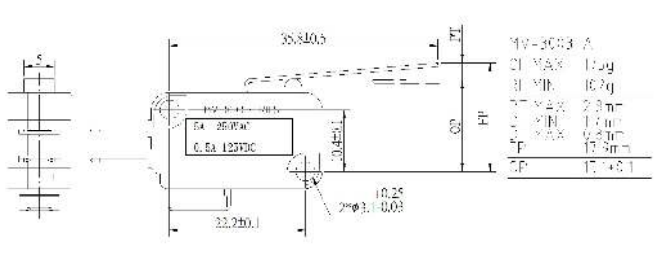
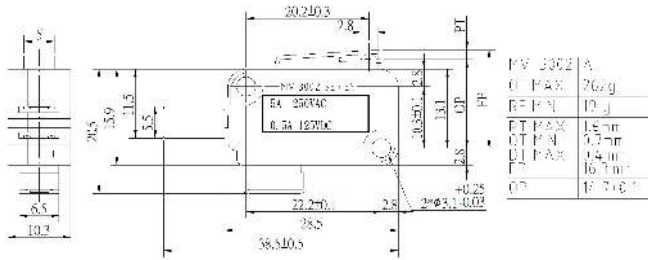
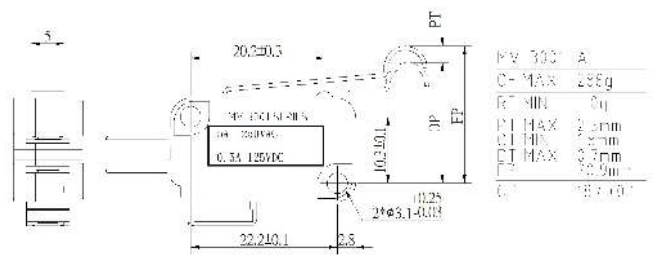
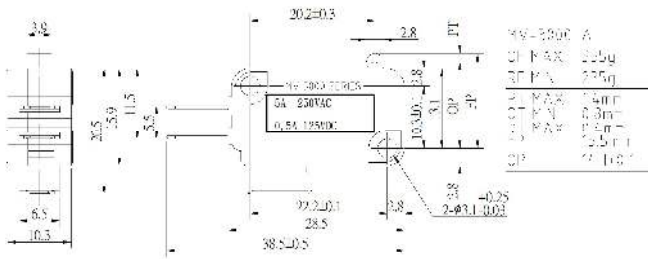

MV-3003L A
OF MAX 112g
RF MIN 60g
PT MAX 6.2mm
OT MIN 4.2mm
DT MAX 1.5mm
FP MAX 20.6mm
OP 14.4±1.2



MV-3003AL



MV-3000A



MV-3001A



MV-3002A



MV-3003A



MV-3004A



MV-3005A

MV-3

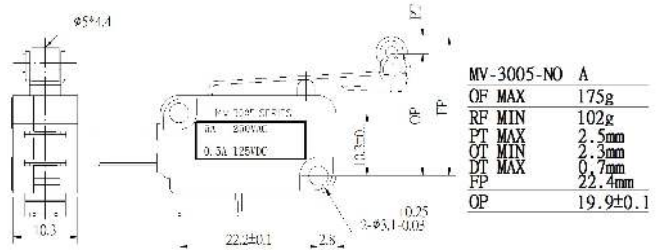
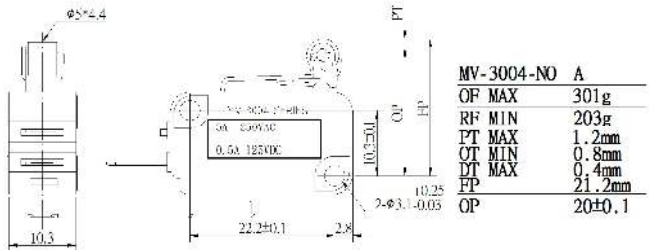
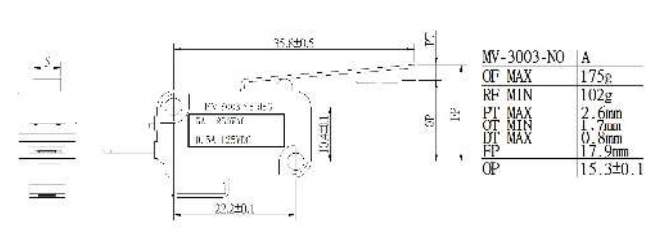
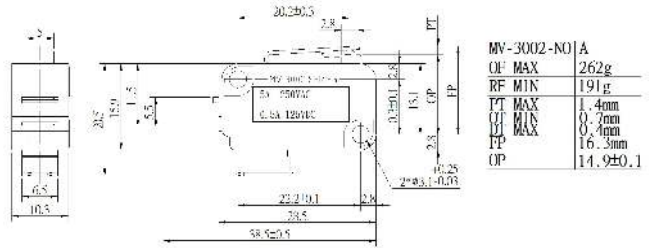
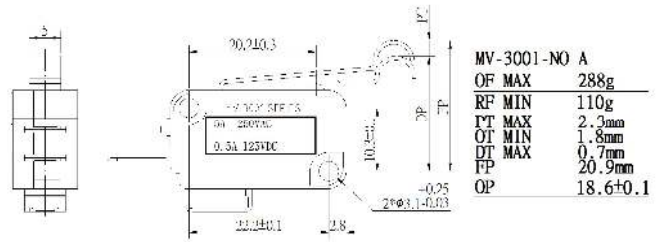
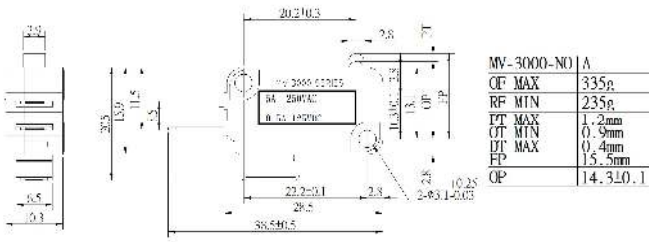

MV-3000A-NO



MV-3001A-NO



MV-3002A-NO



MV-3003A-NO



MV-3004A-NO



MV-3005A-NO

MV-3

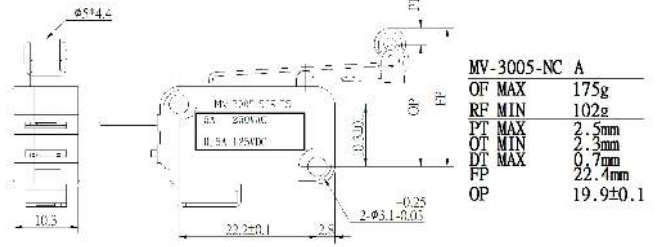
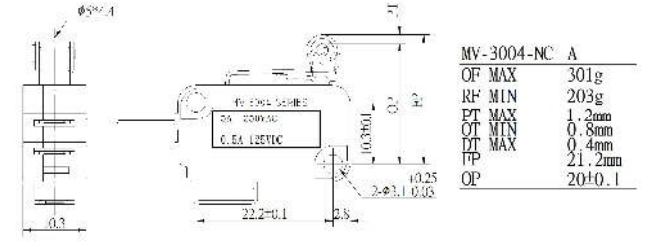
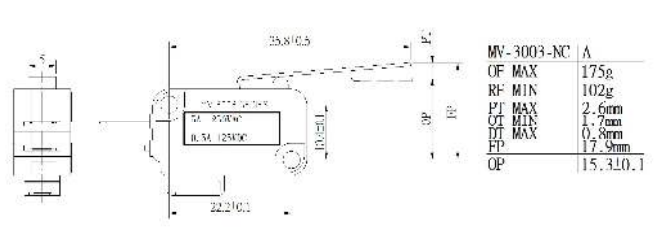
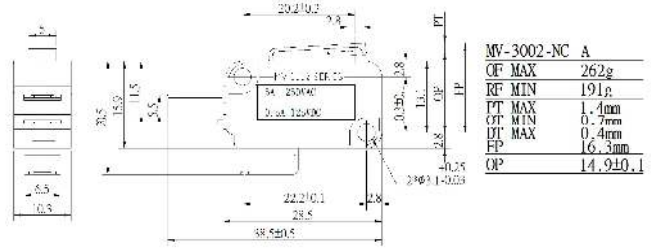
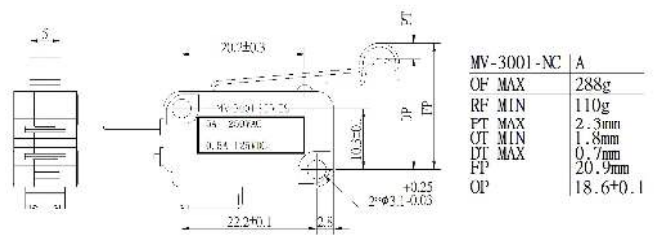
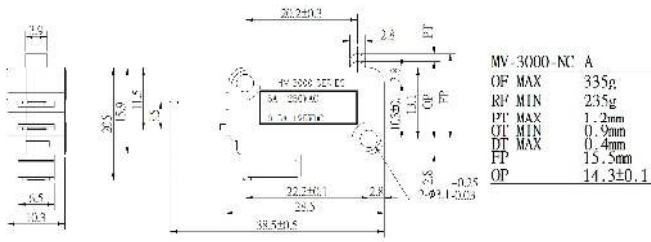

MV-3000A-NC

MV-3001A-NC

MV-3002A-NC

MV-3003A-NC

MV-3004A-NC

MV-3005A-NC

Precautions for Safe Use

- Be sure to ground. Otherwise electric shock may result.
- Do not touch charged switch terminals while the switch is carrying current, otherwise electric shock may result.
- Do not disassemble or touch the inside while the power is turned on, otherwise electric shock may result.
- Do not handle products without proper protective gears; doing so may result in injury.
- Connect a fuse which has 1.5 to 2 times higher breaking current than the product, in order to prevent products from short-circuit damage.
- On the occasion when using the switch with EN/IEC/GB ratings, use a 10 A fuse that complies IEC60269, either type gG or gL.
- Operating conditions will affect product durability. Be sure to check with actual using conditions before usage.
- Do not drop the switch.
- Do not connect a Single Limit Switch to two power supplies that are different in polarity or type. This may increase the risk of interference.
- Be sure to keep the load current less than the rated value. Otherwise, there is the possibility that the switch may be damaged and/or burnout.
- Do not use the Switch by itself in atmospheres containing flammable or explosive gases. Arcs and heat resulted from constant actuating may cause fire or explosion.
- Be sure to prevent foreign materials such as scrapped cable intrusion into the switch when wiring. Otherwise, there is the possibility of spoiling normal operations.
- Do not wire to the wrong terminals.
- Using the Switch in a pressed-in state for an extended period of time can accelerate part deterioration and also lead to failure to return to the original position. Check the Switch beforehand, and perform periodic inspection and replacement.
- Do not store or use the switch at the following places: (i)where the temperature fluctuates greatly. (ii)where the humidity is very high and condensation may occur. (iii)Where the vibration is great. (iv)Where there is direct sun light. (v)Where exposed to salty winds. (vi)Where exposed to cutting powder, machining chips, oil, and chemicals inside the protective doors. (vii)Where exposed to cleansers, thinners, and other solvents.
- Do not use or store the Switch in locations with corrosive gas, such as sulfuric gas (H₂S or SO₂), ammonium gas (NH₃), nitric gas (HNO₃), or chlorine gas (Cl₂), or high temperature and humidity. Otherwise, contact failure or corrosion damage may result.
- Do not disassemble and/or modify the switch at any time. Otherwise, there is the possibility of spoiling the normal operation.
- Do not apply deformative and/or degenerative forces to products.
- If products have been used over an extended period of time or uses stated in products datasheets, contact reliability may still degrade due to natural oxidation; resulting in inadequate conductivity, which may lead to an accident. Please swiftly preform inspections and insure proper replacements are carried out.
- Only allow certified professionals to preform installing and maintenance tasks.

Precautions for Correct Use

Operating Environment

- This switch is only for indoor use. If it is used in outdoor, it may cause switch failure.
- Take special care if products are to be used at places where there is fine powder, mud and/or foreign materials accumulating. Check actual using conditions before using. If this is unavoidable, highly recommend integrating protective equipment. This is considered not Moujen's obligations.
- Seal material may deteriorate if a Switch is used outdoor or where subject to special cutting oils, solvents, or chemicals. Always appraise performance under actual application conditions and set suitable maintenance and replacement periods. This is considered not Moujen's obligations.
- Install Switches where they will not be directly subject to cutting chips, dust, or dirt. The Actuator and Switch must also be protected from the accumulation of cutting chips or sludge.

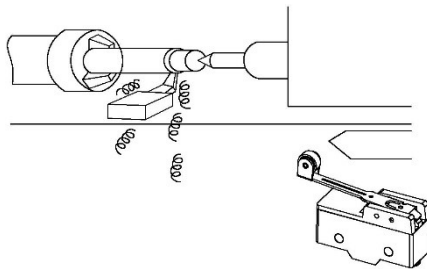

✓ Correct

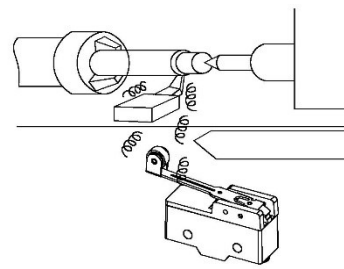

✗ Incorrect

- Constantly subjecting a Switch to vibration or shock can result in wear, which can lead to contact interference with contacts, operation failure, reduced durability, and other problems. Excessive vibration or shock can lead to false contact operation or damage. Install Switches in locations not subject to shock and vibration and in orientations that will not produce resonance.
- The Switches have physical contacts. Using them in environments containing silicon gas will result in the formation of silicon oxide (SiO_2) due to arc energy. If silicon oxide accumulates on the contacts, contact interference can occur. If silicon oil, silicon filling agents, silicon cables, or other silicon products are present near the Switch, suppress arcing with contact protective circuits (surge suppressor) or remove the source of silicon gas.
- If the Switch will be left in a location outside the storage environment conditions, if condensation has formed, or after long term storage exceeding one year, at the minimum, check the operating characteristics, contact resistance, insulation resistance, and dielectric strength. And conduct a check under the operating conditions.

Handling & Usage

- Do not remove or replace any built-in switches. Doing so may damage the product, resulting in increased risk of malfunctioning.
- Do not use excessive force to insert, remove or twist keys of key-selector products. Doing so may damage the product, resulting in increased risk of malfunctioning.
- Do not actuate products and hold its position for excessive amounts of time. Doing so will reduce the life of the internal spring as well as structural integrity; thus, increase risk of malfunctioning.
- Do not bend or twist cables with excessive force. When bending is required, provide a bending radius of 45 mm min. so as not to damage the cable insulation or sheath. Excessive bending may cause fire or leakage current.
- To change the installation position of the actuator: By loosening the Allen-head bolt on the actuator lever, the position of the actuator can be set anywhere within 360°.
- To change the orientation of the head: By removing the head screws (two or four screws), mounting in any of four orientations is possible. Be sure to change the plunger for internal operations at the same time. The roller plunger can be set in either of two positions at 90°.
- Flipping the roller to a different side: Loosen the Allen-head bolt, allows flipping the roller to the opposite side.
- Adjusting the length of the rod or lever: The length of the rod or lever can be adjusted by loosening the Allen-head bolt.
- Adjusting the rolling arm lever: (i) The roller arm can be set freely within a range of 225° after loosening the nut. (ii) The roller arm mounting bracket can be set in any direction after loosening the nut.

Mounting and Tightening

- Please view each individual product page's allowed parameters for details.
- Please follow these parameters diligently. Otherwise products may not function properly.

Wiring & Cabling

- Use M3.5-nylon insulation covered crimp terminals (round type)
- Appropriate wire size is AWG18.
- Do not supply electric power when wiring. Otherwise electric shock may result.
- Do not pull on the wires with excessive force.
- Avoid connecting the wires directly to the terminal. Instead, attach using a crimp terminal.
- Grounding is only installed on models with ground terminals.
- In the case of prewired connector and direct connector: Holding the connector certainly when pulling connector. Do not pull the cable with excessive force.

Conduit Installation

- The connector must be tightened at a suitable tightening torque. Tightening with excessive torque could damage the case.
- Select the connector based on the sealed rubber inner diameter for matching the cable outer diameter.
- When mounting the connector, use seal tape (not needed if the connector includes an O-ring) on the threaded section of the connector to ensure sealing performance.
- To ensure compliance of this Switch with the CSA standards, use of a waterproof connector compliant to CSA regulations.
- Using an inappropriate connector or assembling Switches incorrectly (assembly, tightening torque) can result in malfunction, leakage current, or fire. Be sure to read the connector instruction manual thoroughly beforehand.
- Even when the connector is assembled and set correctly, ends of the cable inside the Switch may come in contact. This can lead to malfunction, leakage current, or fire. Thus, be sure to protect the end of the cable from splashes of oil or water and corrosive gases.
- The following wiring is recommended for preventing the entry of fluids from the conduit opening.

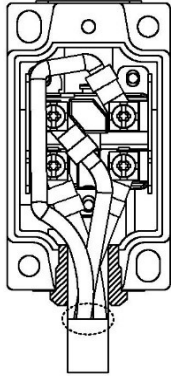

No envelopment of cable jacket in conduit. Exposed single wires.

✗ **Incorrect**

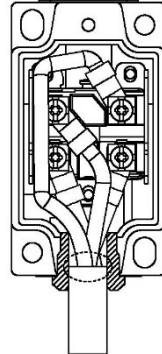

Partial/loose envelopment of cable jacket in conduit

✗ **Incorrect**

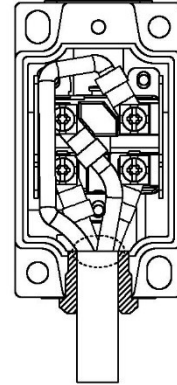

Full envelopment of cable jacket in conduit.

✓ **Correct**

Actuating Terminology

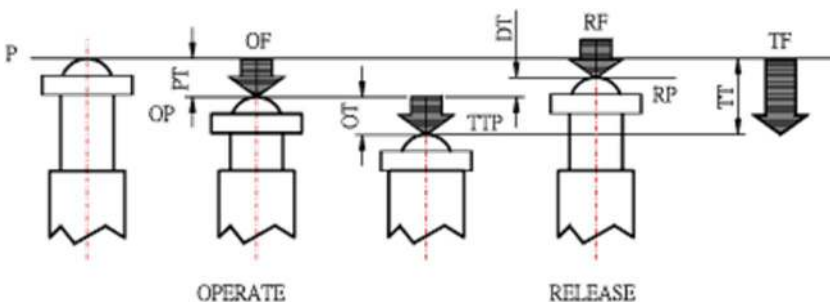

OF: Operating Force	TTP: Total Travel Position
RF: Releasing Force	PT: Pretravel
TF: Total Force	OT: Overtravel
FP: Free Position	DT: Travel Differential
OP: Operating Position	TT: Total Travel
RP: Releasing Position	

Integrating into systems – Limit Switches

- Carefully determine the position and shape of the dog or cam so that the actuator will not abruptly snap back, thus causing shock. In order to operate the Limit Switch at a comparatively high speed, use a dog or cam that keeps the Limit Switch turned ON for a sufficient time so that the relay or valve will be sufficiently energized.
- The method of operation, the shape of the cam or dog, the operating frequency, and the travel after operation have a large influence on the durability and operating accuracy of the Limit Switch. The cam or dog must be smooth in shape.

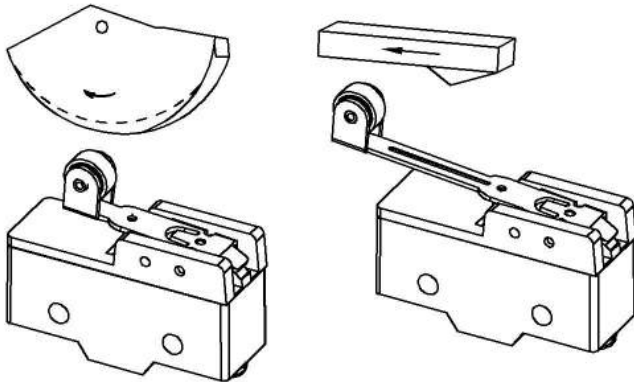

✓ Correct

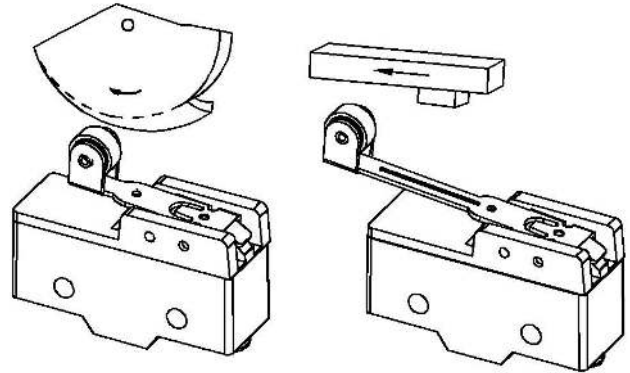

✗ Incorrect

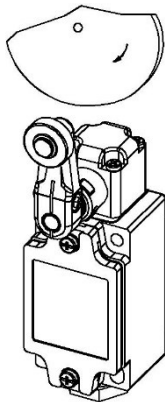

✓ Correct

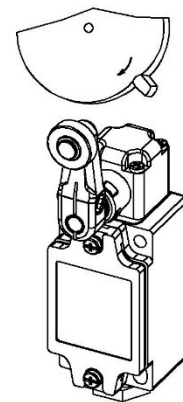

✗ Incorrect

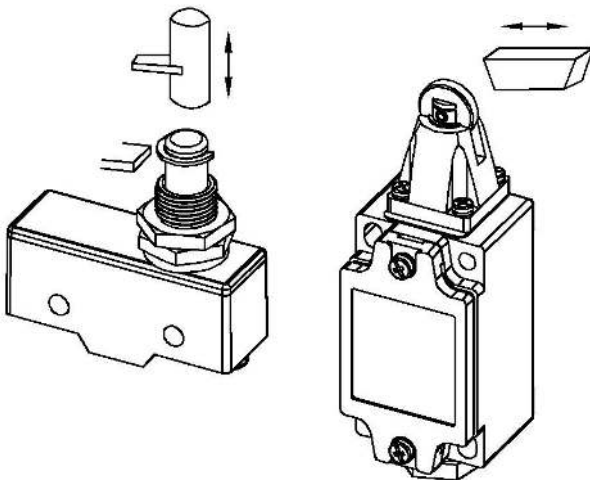

✓ Correct

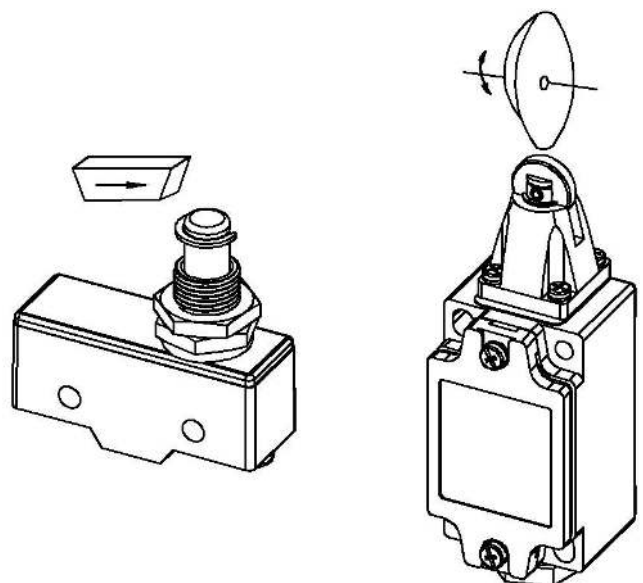

✗ Incorrect

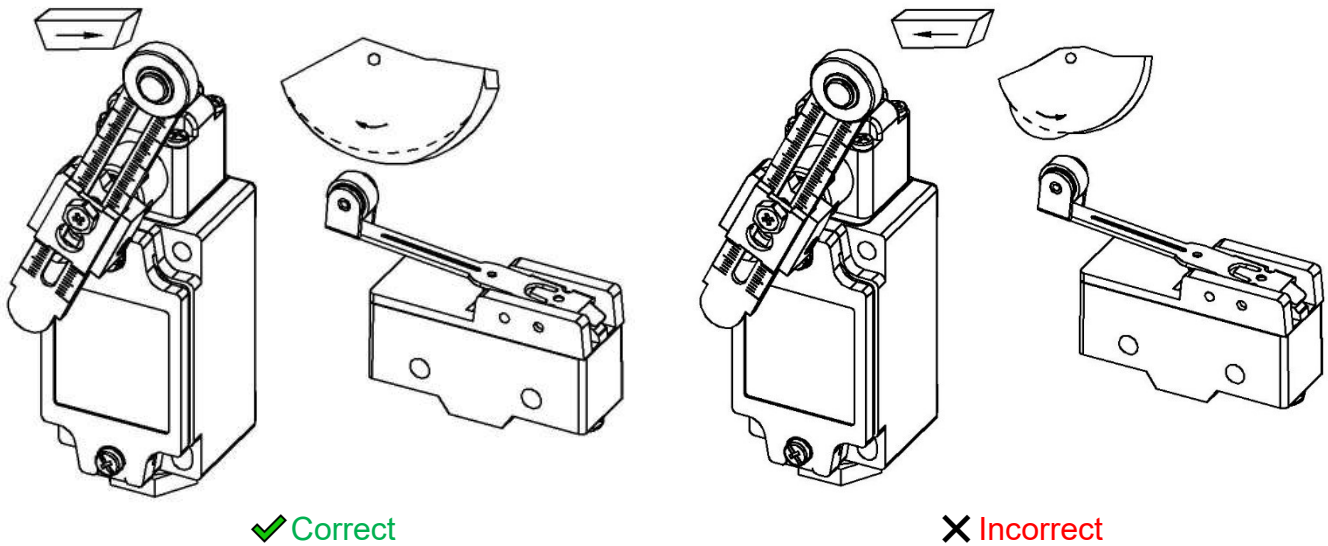

• Appropriate force must be imposed on the actuator by the cam or dog in both rotary operation and linear operation. If the dog touches the lever as shown below, the operating position will not be stable.

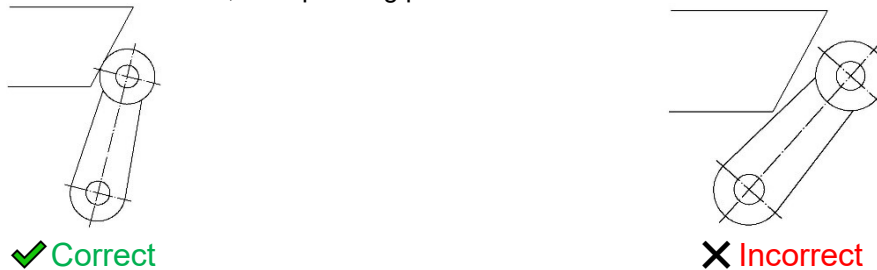

• Unbalanced force must not be imposed on the actuator. Otherwise, wear and tear on the actuator may result.

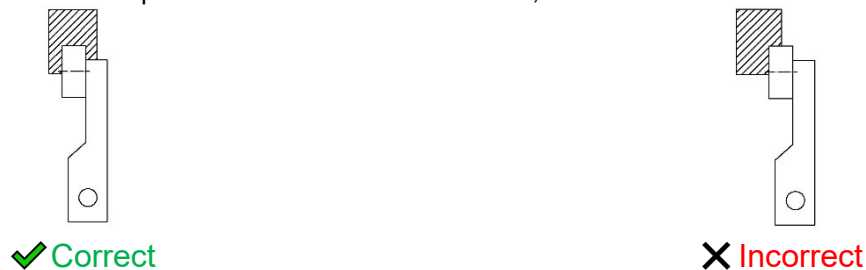

• Mount so that the actuator travel after operation (OT) is not exceeded. If the travel after operation (OT) exceeds the limit, switch failure could result. When mounting the Limit Switch, be sure to adjust the Limit Switch carefully while considering the whole movement of the actuator.

• When using a pin-plunger actuator, make sure that the stroke of the actuator and the movement of the dog are located along a single straight line.

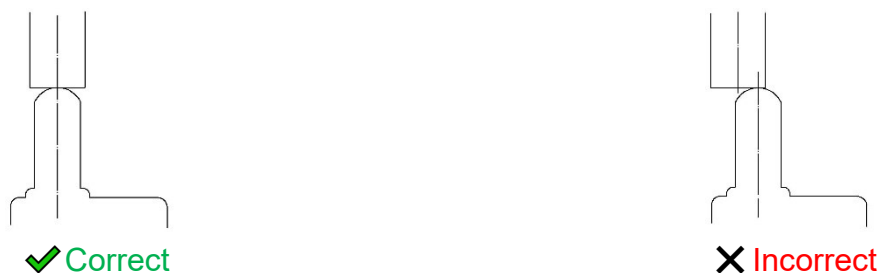

Terms and Conditions Agreement

Read and understand

Please carefully read and understand all information published (on all platforms authorized by Moujen), before purchasing. Purchasing any Moujen products expresses your understanding and agreement towards the terms and conditions erected by Moujen Electric Co., Ltd. If you do not understand any information published, you are always welcome to consult with an official Moujen representative, and other authorized affiliates.

Limited Warranty

- (a) LIMITED WARRANTY. MOUJEN'S LIMITED WARRANTY WARRANTS THAT PRODUCTS WILL BE FREE FROM DEFECTS IN MATERIALS AND WORKMANSHIP FOR A PERIOD OF TWELVE MONTHS; FROM THE DATE OF SALE BY MOUJEN (OR SUCH OTHER PERIOD EXPRESSED IN WRITING BY MOUJEN). MOUJEN DISCLAIMS ALL OTHER WARRANTIES, EXPRESS OR IMPLIED.
- (b) MOUJEN MAKES NO WARRANTY OR REPRESENTATION, EXPRESS OR IMPLIED, ABOUT A PARTICULAR PURPOSE OF THE PRODUCTS. BUYER ACKNOWLEDGES THEMSELVES THAT THE PRODUCTS WILL SUITABLY MEET THE REQUIREMENTS OF THEIR INTENDED USE.
- (c) Resolutions. Moujen's sole obligation shall be, at Moujen's discretion, to: (i) replace the non-complying Product (in the form originally shipped. Buyer is responsible for labor charges for removal or replacement thereof.), (ii) repair the non-complying Product, or (iii) repay or credit Buyer an amount equal to the purchase price of the non-complying Product.

All resolutions must first be initiated through Return Merchandise Authorization procedures. Only testing sample products may not initiate Return Merchandise Authorization procedures. Only gratuitous and testing sample products are not subjected to monetary obligations; and have Limited Liabilities.

Moujen shall not be responsible for warranty, repair, indemnity or any other claims or expenses regarding Products unless Moujen's analysis confirms that the Products were properly handled, stored, installed and maintained; and not subject to contamination, abuse, misuse or inappropriate modification. Return Merchandise Authorization of any Products by Buyer must be approved in writing by Moujen and authorized affiliates.

Moujen further disclaims all warranties and responsibilities of any type for claims or expenses based on infringements by Products or otherwise of any intellectual property rights. Moujen shall not be liable for the suitability or unsuitability or the results from the use of Products in combination with any electrical or electronic components, circuits, system assemblies or any other materials or substances or environments. Any advice, recommendations or information given orally or in writing, are not to be interpreted as an amendment or addition to the above warranty.

Return Merchandise Authorization

All Buyers initiating Return Merchandise Authorization (also known as RMA) must provide Proof of Transaction documentation, and Pictures or Videos detailing potentially non-compliant areas. All received information and documentation are subjected to Moujen's Privacy Policy.

- (a) Non-compliance inquiries: Buyers initiating RMA may provide Moujen and affiliates, to their best knowledge, with: (i) Pictures or Videos of how products are installed in system(s), (ii) Pictures or Videos of how products are actuated in system(s), (iii) Pictures or Videos of electrical energies subjugated to Moujen products, (iv) System schematics relating to Moujen product in question, and (v) Pictures or Videos of packaging when received.

Additionally, once products are in shipped state, Moujen retains full rights to not accept and/or authorize returns due to Buyer's own mismanagement. Signed orders shall not be subject to cancellation or modification either in whole or in part without Seller's written consent and then only with terms that will reimburse Seller for all applicable costs incurred by virtue of the sale; including costs of purchased materials, engineering costs and a reasonable allowance for profit. Seller's written consent must be given in advance of Buyer's return of Products for credit. Seller reserves the right to cancel any sale of Products without liability to Buyer (except for refund of monies already paid), if the manufacture or sale of the goods is or becomes technically or economically impractical.

Limitation on Liability

MOUJEN SHALL NOT BE LIABLE FOR SPECIAL, INDIRECT, INCIDENTAL, OR CONSEQUENTIAL DAMAGES, LOSS OF PROFITS, OR PRODUCTION OR COMMERCIAL LOSS IN ANY WAY CONNECTED WITH THE PRODUCTS, WHETHER SUCH CLAIM IS BASED IN CONTRACT, WARRANTY, NEGLIGENCE OR STRICT LIABILITY.

Moujen disclaims any and all liability for any errors, inaccuracies or incompleteness contained in any datasheet or in any other disclosure relating to any product. Statements regarding the suitability of products for certain types of applications are based on Moujen's knowledge of typical requirements that are often placed on Moujen products in generic applications. Such statements are not binding statements about the suitability of products for a particular application. IT IS THE CUSTOMER'S RESPONSIBILITY TO VALIDATE THAT A PARTICULAR PRODUCT WITH THE PROPERTIES DESCRIBED IN THE PRODUCT SPECIFICATION IS SUITABLE FOR USE IN A PARTICULAR APPLICATION. Parameters provided in datasheets and/or specifications may vary in different applications and performance may vary over time. All operating parameters, including typical parameters, must be validated for each customer application by the customer's technical experts. Product specifications do not expand or otherwise modify Moujen's terms and conditions of purchase, including but not limited to the warranty expressed therein. Further, in no event shall liability of Moujen exceed the individual price of the Product on which liability is asserted.

Suitability of Use

Moujen shall not be responsible for conformity with any standards, codes or regulations which apply to the combination of the Product in the Buyer's application, or use of the Product. At Buyer's request, Moujen will provide applicable third-party certification documents identifying ratings and limitations of use which apply to the Product. This information by itself is not sufficient for a complete determination of the suitability of the Product in combination with the end product, machine, system, or other application or use. Buyer shall be solely responsible for determining appropriateness of the particular Product with respect to Buyer's application, product or system. Buyer shall take application responsibility in all cases.

NEVER USE THE PRODUCT FOR AN APPLICATION INVOLVING SERIOUS RISK TO LIFE OR PROPERTY OR IN LARGE QUANTITIES WITHOUT ENSURING THAT THE SYSTEM AS A WHOLE HAS BEEN DESIGNED TO ADDRESS THE RISKS, AND THAT THE MOUJEN PRODUCT(S) IS PROPERLY RATED AND INSTALLED FOR THE INTENDED USE WITHIN THE OVERALL EQUIPMENT OR SYSTEM.

Specifications

ALL PRODUCT, PRODUCT SPECIFICATIONS AND DATA, THROUGH CONTINUOUS RESEARCH, ARE SUBJECT TO CHANGE WITHOUT NOTICE TO IMPROVE RELIABILITY, FUNCTION OR DESIGN OR OTHERWISE.